

S5800E Series Field Comm Analyzer

User Manual



This manual applies to the instruments of the following models:

- S5800EA Field Comm Analyzer (9kHz - 4.0GHz).
- S5800EB Field Comm Analyzer (9kHz - 6.0GHz).

Standard Accessories of S5800E series field comm analyzer:

Item	Name	Qty.
1	Main Machine	1 pcs
2	AC/DC Adapter	1 pcs
3	Rechargeable Li-ion Battery	1pcs
4	Vehicle Charger 12V/DC (<0.5Ω)	1 pcs
5	Crossover LAN Cable	1 pcs
6	USB Cable	1 pcs
7	RF Connector	1 pcs
8	Soft Carrying Case	1 pcs
9	CD (Site Workbench Software and Manual)	1 pcs

Options of the S5800E series field comm analyzer:

Option No.	Item	Description
S5800-01	RF Power Meter (Software)	Providing true RMS measurements with accurate measurements for both CW and complex digitally modulated signals.
S5800-02	In-line Bi-Directional RF High Power Sensor	300 MHz to 4GHz, 2mW to 150W, N(f) 50Ω
S5800-03	Terminal RF Power Sensor	1MHz to 6GHz, -30dBm to +20dBm, N(m), 50Ω
S5800-04	Interference Location Analysis	Add Spectrogram, RSSI, Signal ID, Signal Strength, Interference Location Mapping, Delta Spectrum and DPS measurement applications to the spectrum analyzer. (Need directional log periodic antenna)
S5800-05	Signal Coverage Mapping	Allowing users to map RSSI and ACPR measurements. (Need option S5800-06)
S5800-06	GPS Module (USB)	/
S5800-07	Signal Analysis	LTE,WCDMA,TDSCDMA,GSM,CDMA
S5800-08	Tracking Generator	Frequency range: 25MHz - 4.4GHz

Option No.	Item	Description
S5800-09	Tracking Generator	Frequency range: 25MHz - 6.0GHz
S5800-10	Spectrum Persistence	Find interference covered by transmit signal.Acquires several thousands of spectrum data per second and show the spectrum density over time.
S5800-11	Gate Sweep	For TD signal analysis
S5800-12	Directional Active Log Periodic	Frequency range: 9 kHz to 20MHz
S5800-13	Directional Active Log Periodic	Frequency range: 20MHz to 200MHz
S5800-14	Directional Active Log Periodic	Frequency range: 200MHz to 500MHz
S5800-15	Directional Active Log Periodic	Frequency range: 500MHz to 3GHz
S5800-16	Directional Active Log Periodic	Frequency range: 500MHz to 8GHz
S5800-17	Antenna Handle with GPS and Electronics Compass	/

Preface

Thanks for choosing S5800E series field comm analyzer produced by Saluki Technology Inc. Please read this quick guide carefully for your convenience.

We devote ourselves to meeting your demands, providing you high-quality measuring instrument and the best after-sales service. We persist with “superior quality and considerate service”, and are committed to offering satisfactory products and service for our clients.

Document No.

S5800E-03-01

Version

Rev01 2019.08

Saluki Technology

Authorization

The information contained in this manual is subject to change without notice. The power to interpret the contents of and terms used in this guide rests with Saluki.

Saluki Tech owns the copyright of this document which should not be modified or tampered by any organization or individual, or reproduced or transmitted for the purpose of making profit without its prior permission, otherwise Saluki will reserve the right to investigate and affix legal liability of infringement.

Product Quality Certificate

The product meets the indicator requirements of the manual at the time of delivery. Calibration and measurement are completed by the measuring organization with qualifications specified by the state, and relevant data are provided for reference.

Quality/Environment Management

Research, development, manufacturing and testing of the product comply with the requirements of the quality and environmental management system.

Contacts

Service Tel:	886.909 602 109
Website:	www.salukitec.com
Email:	sales@salukitec.com
Address:	No. 367 Fuxing N Road, Taipei 105, Taiwan (R.O.C.)

CONTENTS

Chapter 1 General Information.....	10
1.1 Overview.....	10
1.2 Standard Accessories.....	10
1.3 Available Product Measurement Options.....	11
1.4 Preventative Maintenance.....	12
1.5 Calibration Requirements & Annual Verification.....	12
1.6 ESD Caution.....	12
1.7 Battery Replacement.....	13
1.8 Soft Carrying Case.....	13
Chapter 2 Instrument Overview.....	15
2.1 Turning on the Instrument.....	15
2.1.1 Front panel overview.....	16
2.1.2 Test panel connector overview.....	17
2.2 UI Overview.....	18
2.2.1 Screen information.....	18
2.2.2 Menu operation.....	18
2.2.3 Symbols and indicators.....	19
2.2.4 Data entry.....	20
2.3 Mode Selector Menu.....	20
2.4 Menu Trees.....	21
2.4.1 AMPTD.....	21
2.4.2 CPL.....	23
2.4.3 FREQ.....	24
2.4.4 MARK.....	25
2.4.5 MEAS.....	26
2.4.6 MEAS SETUP.....	27
2.4.7 PEAK.....	28
2.4.8 SYS.....	29
Chapter 3 Spectrum Measurement.....	15
3.1 Measurement Type Selection.....	30

3.2 Swept SA.....	30
3.2.1 Basic measurement.....	30
3.2.2 Basic parameters setting.....	42
3.2.3 Measurement parameters setting.....	52
3.2.4 Basic usages.....	56
3.3 Channel Power.....	64
3.3.1 Basic measurement.....	64
3.3.2 Basic parameter setup.....	70
3.3.3 Measurement parameter setup.....	70
3.3.4 Basic usage.....	72
3.3.5 Burst RF basic parameters setup.....	73
3.3.6 Burst RF measurement setup.....	74
3.4 Adjacent Channel Power.....	75
3.4.1 Basic measurement.....	76
3.4.2 Basic parameter setup.....	77
3.4.3 Measurement parameter setup.....	78
3.4.4 Basic usage.....	80
3.5 Occupied BW.....	81
3.5.1 Basic measurement.....	82
3.5.2 Basic parameter setup.....	83
3.5.3 Measurement parameter setup.....	83
3.5.4 Basic usage.....	84
3.6 Field Strength.....	85
3.7 FM/AM.....	86
Chapter 4 Interferometric Analysis.....	88
4.1 Spectrogram.....	88
4.2 Signal Strength.....	89
4.3 RSSI.....	89
4.4 Channel Scan.....	90
4.5 Interference Localization.....	90
4.6 Difference Spectrum.....	91
4.7 Signal ID.....	91
Chapter 5 Basic Stations Analyzer.....	93

5.1 TDD-LTE.....	93
5.1.1 Power vs. Resource block.....	94
5.1.2 Constellation.....	98
5.1.2 Control channel power.....	100
5.1.3 Summary.....	100
5.1.4 OTA scanner.....	101
5.1.5 Tx Test.....	103
5.1.6 Channel Power.....	104
5.1.7 ACLR.....	104
5.1.8 Occupied bandwidth.....	105
5.1.9 Power vs. Time.....	105
5.1.10 CCI.....	106
5.1.11 ULI.....	108
5.1.12 MIMO.....	110
5.2 FDD-LTE.....	111
5.2.1 Power vs. Resource block.....	112
5.2.2 Constellation.....	116
5.2.3 Control channel power.....	118
5.2.4 Summary.....	118
5.2.5 OTA scanner.....	119
5.2.6 Tx test.....	121
5.2.7 Channel power.....	122
5.2.8 ACLR.....	123
5.2.9 Occupied bandwidth.....	123
5.2.10 SEM.....	124
5.2.11 CCI.....	125
5.2.12 MIMO.....	127
Chapter 6 Coverage Mapping.....	130
6.1 SS Indoor.....	130
6.1.1 Measure setting.....	130
6.1.2 Coverage measure.....	133
6.1.3 Save file of measure.....	135
6.1.4 Open file.....	136

6.2 SS Outdoor.....	138
6.2.1 Coverage measure.....	138
6.2.2 Save file.....	140
6.3 TDLTE Outdoor.....	141
6.4 FDLTE Outdoor.....	142
6.5 Net Clean Outdoor.....	143
Chapter 7 Track Generator.....	145
Chapter 8 File Managing.....	147
8.1 File Saving.....	147
8.1.1 Image file saving.....	147
8.1.2 Status file saving.....	148
8.1.3 Trace+Status file saving.....	149
8.2 File Management.....	149
8.2.1 Image file management.....	150
8.2.1 Image file management.....	152
8.2.2 Trace+Status file management.....	152
8.2.3 Limit file management.....	153
Chapter 9 Other Functions and Settings.....	155
9.1 System Calibration.....	156
9.2 Help Menu.....	157
9.3 System Configuration.....	160
9.3.1 Power on status selection.....	160
9.3.2 Preset.....	160
9.3.3 Network setting.....	160
9.3.4 Printer setting.....	162
9.3.5 Data & Time setting.....	162
9.3.6 Buzzer config.....	163
9.3.7 GPS setup.....	163
9.4 Software Update.....	164
Chapter 10 Programming Guide.....	165
10.1 SCPI Language Basics.....	165
10.1.1 Command keyword and syntax.....	165
10.1.2 Creating valid commands.....	165

10.1.3 Special characters in commands.....	166
10.1.4 Parameters in commands.....	166
10.1.5 Variable parameters.....	167
10.1.6 Block program data.....	167
10.2 Instructions.....	167
10.2.1 Common command.....	167
10.2.2 System command.....	168
10.2.3 Spectrum control command.....	168

Chapter 1 General Information

Introduction

This chapter provides a general description of the S5800E Series Field Comm Analyzer. Topics covered in the section include the following:

- Overview
- Standard Accessories
- Available Measurement Options
- Preventive Maintenance
- Calibration Requirements&Annual Verification
- ESD Caution
- Battery Replacement
- Soft Carrying Case

1.1 Overview

The S5800EA/B Field Comm Analyzer is an economic instrument which is integrated multi-functional analyzer that eliminates the need to carry and learn multi instrument. In additional spectrum analyzing, the S5800E can be configured to include power measurement, occupied bandwidth measurement, interference analyzer, track generator and a high accuracy GPS receiver for location stamping.

The bright 6.5-inch color display provides visibility even in hard light. Built-in Li-Ion battery can work more than 3.5 hours

The internal 1G flash memory is large enough to store approximately 2,000 traces or setup files. Measurements data and setup files can also be stored in a USB flash disk or transferred to PC via the LAN cable.

Site Workbench, a PC based software program, provides a simple and easy way to manage, archive, analyze and print measurement reports, customize your cable list, antenna list and signal standards list .

Model	Frequency Range
S5800EA	9kHz - 4.0GHz
S5800EB	9kHz - 6.0GHz

1.2 Standard Accessories

The following components are included with S5800E series field comm analyzer:

- Rechargeable Li-Ion Battery: 11.1V/5.2Ah
- AC/DC Adapter, 12.5-19 VDC
- Vehicle Charger 12V/DC (<0.5Ω)

- Crossover LAN Cable
- USB Cable
- RF Connector
- Site Workbench Software and Documentation disc
- Soft Carrying Case

NOTE: When using the Vehicle charger, Make sure that the supply is rated for a minimum of 60 Watts at 12 VDC, and the socket is clean without any dirt or debris. If the adapter plug becomes hot to the touch during charging, Please discontinue use immediately.

1.3 Available Product Measurement Options

Option No.	Item	Description
S5800-01	RF Power Meter (Software)	Providing true RMS measurements with accurate measurements for both CW and complex digitally modulated signals.
S5800-02	In-line Bi-Directional RF High Power Sensor	300 MHz to 4GHz, 2mW to 150W, N(f) 50Ω
S5800-03	Terminal RF Power Sensor	1MHz to 6GHz, -30dBm to +20dBm, N(m), 50Ω
S5800-04	Interference Location Analysis	Add Spectrogram, RSSI, Signal ID, Signal Strength, Interference Location Mapping, Delta Spectrum and DPS measurement applications to the spectrum analyzer. (Need directional log periodic antenna)
S5800-05	Signal Coverage Mapping	Allowing users to map RSSI and ACPR measurements. (Need option S5800-06)
S5800-06	GPS Module (USB)	/
S5800-07	Signal Analysis	LTE, WCDMA, TDSCDMA, GSM, CDMA
S5800-08	Tracking Generator	Frequency range: 25MHz - 4.4GHz
S5800-09	Tracking Generator	Frequency range: 25MHz - 6.0GHz
S5800-10	Spectrum Persistence	Find interference covered by transmit signal. Acquires several thousands of spectrum data per second and show the spectrum density over time.
S5800-11	Gate Sweep	For TD signal analysis
S5800-12	Directional Active Log Periodic	Frequency range: 9 kHz to 20MHz
S5800-13	Directional Active Log Periodic	Frequency range: 20MHz to 200MHz
S5800-14	Directional Active Log Periodic	Frequency range: 200MHz to 500MHz

Option No.	Item	Description
S5800-15	Directional Active Log Periodic	Frequency range: 500MHz to 3GHz
S5800-16	Directional Active Log Periodic	Frequency range: 500MHz to 8GHz
S5800-17	Antenna Handle with GPS and Electronics Compass	/

The software-enabled measurement options can be added at the time of purchase, or at a later date as your test needs evolve – without having to return the product to Saluki Instruments or one of its authorized service centers.

1.4 Preventative Maintenance

The S5800E series preventive maintenance consists of inspecting and cleaning the unit, all RF connectors, and all accessories. To clean the unit’s surface, use a soft, lint-free cloth dampened with water.

If necessary, the unit case can be cleaned with water and a very mild non-solvent based cleaning solution to remove dirt and light stains.

NOTE: To avoid damaging the display or instrument case, do not use solvents or abrasive cleaners.

Clean the RF connectors and center pins with a cotton swab dampened with denatured alcohol. The fingers of the N(f) connectors and the pins of the N(m) connectors should be unbroken and uniform in appearance. If you are unsure whether the connectors are damaged, gauge the connectors to confirm that the dimensions are correct. The test port cable should be uniform in appearance, and not stretched, kinked, dented, or broken.

1.5 Calibration Requirements & Annual Verification

Local service centers are responsible for instrument maintenance and calibration once a year. To ensure performance conformity Saluki recommends a periodical maintenance and calibration.

The Cable & Antenna Analyzer is calibrated with OPEN, SHORT, LOAD calibration components. It is especially important to verify the OSL calibration components periodically to ensure performance conformity.

1.6 ESD Caution

The S5800E series, like other high performance instruments, is susceptible to electrostatic discharge (ESD) damage. Coaxial cables and antennas often build up a static charge, which may damage the S5800E input circuitry. S5800E series operators must be aware of the potential for ESD damage and take all necessary precautions.

It is recommended to discharge the static by connecting a short or load device to the cable or antenna before connecting them to S5800E. It is important to remember that the operator may also carry a static charge that can cause damage. Following the practices outlined in the above standards will ensure a safe environment for both personnel and equipment.

1.7 Battery Replacement

The battery can be replaced without any tool use. The battery compartment is located on the left rear side (when the display is placed facedown). Remove the two screws, slide the cover down, and remove the battery. Installation is the opposite operation of removal.

NOTE: When inserting the battery, the battery label should face the back of the instrument and the guide slot on the battery should be below the contacts. If the battery door is not latched, the battery may be inserted incorrectly.



Fig.1.1 Battery compartment door

NOTE: Use only batteries, adapters, and chargers provided with this instrument.

CAUTION: When using the vehicle charger, make sure that the supply is rated for a minimum of 60 watts at 12 VDC, and that the socket is clean without any dirt or debris. If the adapter plug becomes hot to the touch during charging, please discontinue use immediately.

NOTE: Saluki recommends removing the battery for long-term storage of the instrument.

1.8 Soft Carrying Case

The S5800E series can be operated while in the soft carrying case. On the back of the case there is a large storage pouch for accessories and power supply.

To install the instrument into the soft carrying case:

1. The front panel of the case is secured with hook-and-loop fasteners. Fully close the front panel of the case. When closed, the front panel supports the shape of the case while you are inserting the S5800E.
2. Place the soft carrying case face down on a stable surface, with the front panel fully closed and laying flat.

NOTE: The soft case has two zippers near the back. The zipper close to the front of the case opens to install/remove the instrument. The zipper close to the back of the case opens an adjustable support panel that can be used to provide support for improved stability and air flow while the instrument is in the case. This support panel also contains the storage pouch.

3. Open the zippered at the back of the case.
4. Insert the instrument face down into the case, take care that the connectors are properly situated in the case top opening. You may find it easier to insert the connectors firstly, and then pull the corners over the bottom of the S5800E.



Fig.1.2 Soft carrying case

Chapter 2 Instrument Overview

Introduction

This chapter describes a brief overview of S5800E series field comm analyzer. Topics covered in this section include the following:

- Turning On the instrument
- Front Panel Overview
- Test Panel Connector Overview
- Display Overview
- Symbols and Indicators
- Data Entry
- Mode Selector Menu
- Menu Trees

2.1 Turning on the Instrument

The S5800E series are capable of approximately 3.5 hours of continuous operation with a fully charged, field-replaceable battery.

The S5800E series can also be operated from a 12 VDC source (which will also simultaneously charge the battery). This can be achieved with either the AC-DC adapter or automotive cigarette lighter adapter. Both items are included in the instrument.

CAUTION: When using Automotive Cigarette Lighter Adapter, Make sure that the supply is rated for a minimum of 60 Watts at 12 VDC, and the socket is clean without any dirt or debris. If the adapter plug becomes hot to the touch during charging, Please discontinue using it immediately.

To turn on the instrument, press the red On/Off button for 2s on the front panel (Fig.2.1). The instrument takes approximately twenty seconds to complete power warm-up and to load the application software. At the completion of this process, the instrument is ready to use.

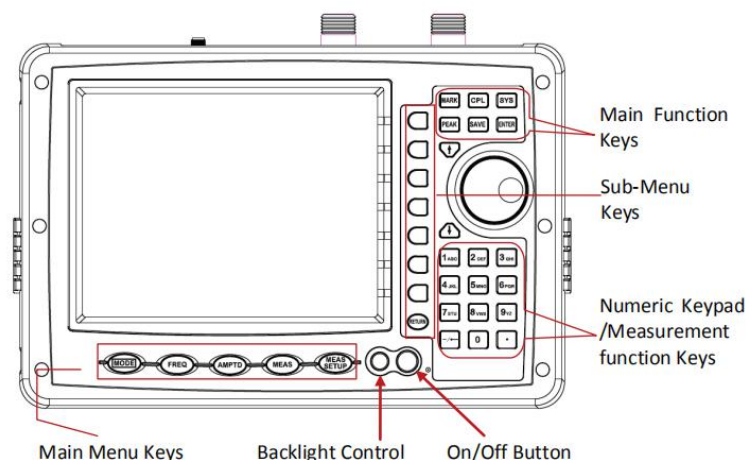

Fig.2.1 S5800E overview

2.1.1 Front panel overview

The S5800E series menu-driven interface is easy to use and requires little training. The S5800E uses the keypad for data input. The five main menu keys below the screen and eight submenu keys on the right side are menu keys. Function keys on the right, consist of six main function keys and twelve measurement function keys. The twelve measurement function keys are dual purpose, depending upon the current mode of operation. The dual-purpose keys are labeled with a number on the key itself and the alternate function is printed in black below each of the keys. Numeric keys are active in parameter edit mode, otherwise measurement function key are activation ones.

NOTE: Keep the fan inlet and exhaust ports clear of obstructions at all times for proper ventilation and cooling of the instrument.

Main Menu Keys

Five main menu keys are below the display screen.

MODE

Press the key, and then select a measurement mode by pressing the corresponding sub-menu key.

NOTE: Available mode selections will vary according to model number and options installed.

FREQ

Display the frequency submenus depending on the current measurement type.

AMPTD

Display the amplitude submenus depending on the current measurement type.

MEAS

Press the key, and then select a measurement type by pressing the corresponding sub-menu key.

MEAS SETUP

Display the measurement parameters setting submenus depending on the current measurement type.

Main Function Keys

There are six main function keys on the top of the panel.

MARK

Active the mark measurement function to open and shut, reading and comparison of the frequency mark.

PEAK

Active the peak measurements function to open and shut, reading and comparison of the frequency peak.

SYS

Allow selection of system and application setup parameters, the display language and system upgrade etc.

SAVE

Active the file saving function

CPL

Set basic parameters of spectrum refer to RBW, VBW, sweep mode, sweep time, trig mode etc.

ENTER

Press this key to finalize data input or select a highlighted item from a list.

“↑ ↓” Arrow Keys

The arrow keys can often be used to change a value or to change a selection from a list. This function is similar to the function of the rotary knob. The arrow keys are also used to move markers.

Rotary Knob

Turning the rotary knob changes numerical value, scrolls through selectable items from a list, and moves markers. Values or items may be within a dialog box or an edit window. Pressing the Rotary Knob is used as “ENTER” key.

Number Keypad

The number keypad has two functions: The primary function is number entry. The secondary function of the number keypad is to list various menus or to implement various measurements.

LED Indicators

Charging LED, is located on the test panel, the LED is red when the battery is charging and is green when the battery is fully charged.

The Power LED, is located to the right of the On/Off key, the LED is green when the unit is on.

2.1.2 Test panel connector overview

The connectors and indicators located on the test panel (Fig.2.2) are listed and described below.

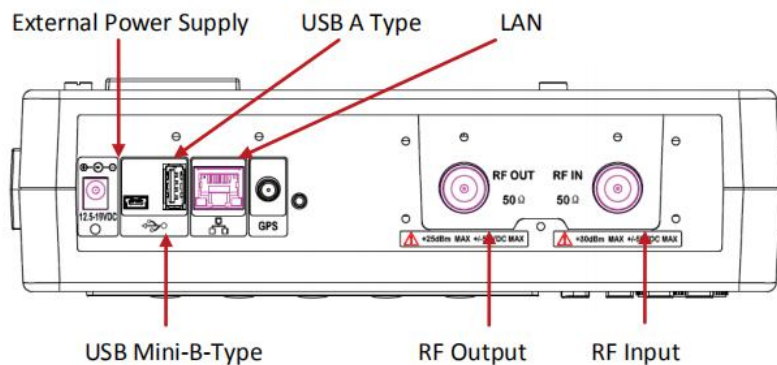

Fig.2.2 S5800E test panel connector overview

External Power

The external power connector is used to power the unit and for battery charging. Input is 12.5 VDC to 19 VDC at up to 3.42A.

USB Interface - Type A

The S5800E has a Type A USB connectors that accept USB flash memory devices for storing measurements, setup data, and screen images, or a GPS module.

USB Interface - Mini B

The USB 2.0 Mini-B connector can be used to connect with a PC.

LAN port

The LAN port is used to connect with a PC loaded the Site Workbench software providing a simple and easy way to manage, archive, analyze, and print measurement reports, antenna list and signal standards list.

RF In

50Ω Type-N female connector. Maximum input is +30 dBm at ±50 VDC.

RF Out

RF output, 50Ω impedance, for tracking generator output. Maximum input is +25 dBm at ±50VDC.

2.2 UI Overview

2.2.1 Screen information

Fig.2.3 describes some of the important information for Spectrum Analysis measurement mode, Swept SA measurement type.

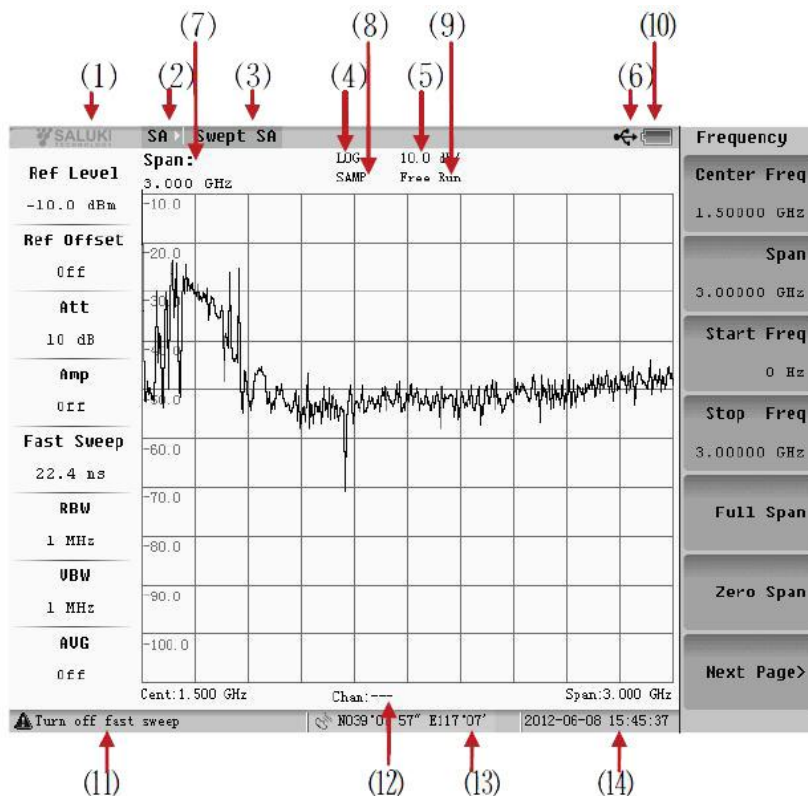

Fig.2.3 Screen information

- | | | |
|------------------------|-----------------------|----------------------|
| (1) Logo | (2) Measurement mode | (3) Measurement type |
| (4) Logarithmic/linear | (5) Scale | (6) USB |
| (7) Parameter setting | (8) Detector mode | (9) Mode of trigger |
| (10) Battery status | (11) Note information | (12) Channel number |
| (13) GPS location | (14) Data/Time | |

2.2.2 Menu operation

There are 8 typical menus and each is described below in detail.

1. Setting parameters

Press the corresponding menu, and the parameter shows in the middle of the screen. Use the numeric keys, arrow keys or Rotary Knob to set the parameter, and press the Enter key to exit.

Example: Menu of “Cent Freq”.

2. Enter the next submenu (no parameter)

Press the corresponding menu key to enter the next submenu. These menus are marked by “>”.

Example: Menu of “Trace>”.

3. Enter the next submenu (with parameter)

Press the corresponding menu key to enter the next submenu to select an option, and then return to the previous menu automatically. These menus are marked by “>”.

Example: Menu of “Detector Mode>”.

4. Active dialog box

Press the corresponding menu key, and there would be a dialog box popped up. These menus are marked by “=>”.

Example: Menu of “Limit=>”.

5. Implement the menu function

Press the menu key to implement the corresponding function.

Example: Menu of “Single Sweep”.

6. Two functions switch (no parameter)

Press the corresponding menu button to switch the two functions.

Example: Menu of “Log/Lin”.

7. Two functions switch (with parameters)

Press the corresponding menu button to switch the two functions, and then return to the previous menu automatically.

Example: Menu of “Ref Offset”.

8. No operation

Some of the menu are not available unless the certain state is met. No operation when the menu grays out.

Example: Menu of “Normal Detector Mode” in the fast sweep mode.

2.2.3 Symbols and indicators

The following symbols and indicators indicate the instrument status or condition on the display.

1. Calibration status OFF



Calibration status OFF;



Frequency response OFF.

2. Hold on



Sweep Hold ON;



Saving result of measure Hold ON.



3. Battery symbols



Green: Battery is 30% to 100% charged;



Yellow: Battery is 10% to 30% charged;

- ☆  Red: Battery is 0% to 10% charged;
- ☆  Bolt and Scroll Bar: Battery is being charged.
- ☆  No battery and only use adapter.

When either the AC-DC Adapter or the 12 VDC adapter is connected, the battery automatically receives a charge, and the battery symbol with the lightning bolt is displayed.

CAUTION: Use only use batteries, adapters, and chargers provided with this instrument.

2.2.4 Data entry

1. Parameter setting

You can set parameters with the numeric keys, the arrow keys and the rotary knob. It is simple to change the parameters quickly with the arrow keys. You can change the parameter continuously with the rotary knob.

2. Edit in position displayed

On a measurement display, many parameters are listed in place. You can move the highlight cursor at the place where a parameter shows, and press the Enter key to begin setting. The numeric keys, arrow keys and the rotary knob can be used to set the parameter. Press Enter to exit.

3. Submenu entry

When pressing the corresponding submenu key, parameter shows on the upper left corner of the display. You can set the parameter using the numeric keys, arrow keys or the rotary knob, and press Enter to exit the editor.

4. Text entry

When saving a Measurement, a Setup or a BMP file, you have to enter the characters and numbers to name it. You edit the name with the numeric keys. You can switch between capital letter and small letter by pressing the “.” key.

For example, inputting “1aB” you will do:

- 1) Press once “1abc”, will entry the number “1”;
- 2) Press twice “1abc”, will entry the number “a”;
- 3) Press “.” once, and then press twice “1abc”, will entry the number “B”;

2.3 Mode Selector Menu

Press the **MODE** key to enter the measurement mode selection menu (Fig.2.4). You can select the desired measurement mode, or enter the next level menu.

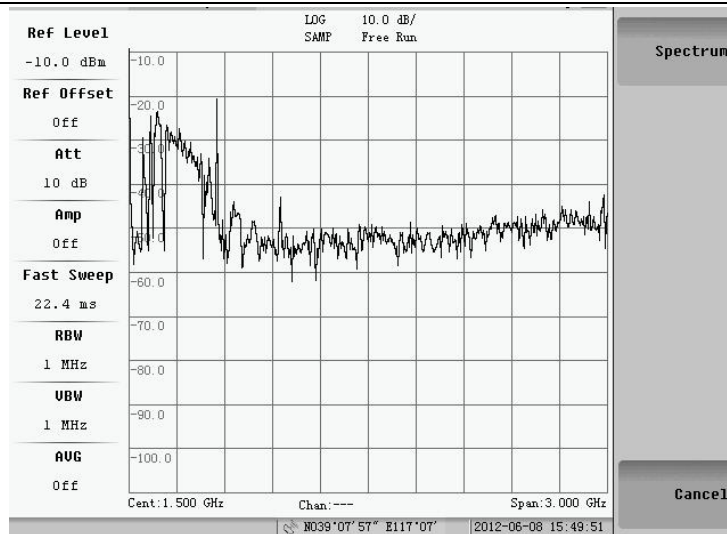

Fig.2.4 Measurement mode selection

2.4 Menu Trees

This part lists the menu trees that ordered by characters. Some menus only can be activated in the instrument with corresponding options.

NOTE: We will list menus as far as possible. Because some measurements are option functions, and some of instruments may be without some menus.

2.4.1 AMPTD

This key works for the different way in different measurements.

- Spectrum Analysis Mode -> Swept SA Type

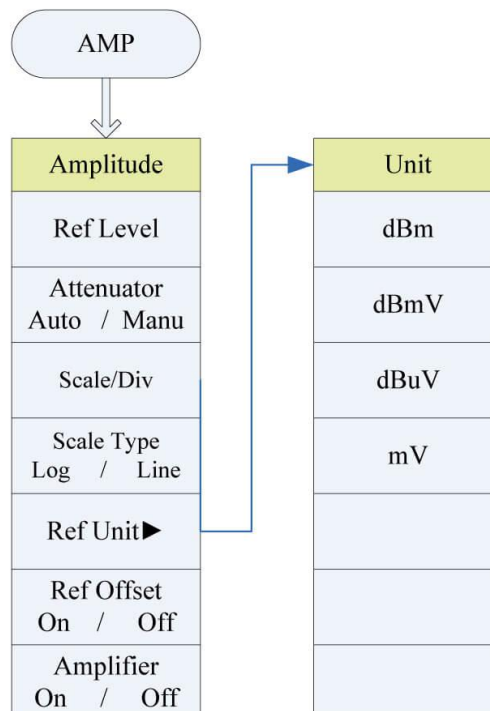

➤ Spectrum Analysis Mode -> Channel Power, ACP and Occupied Bandwidth Type

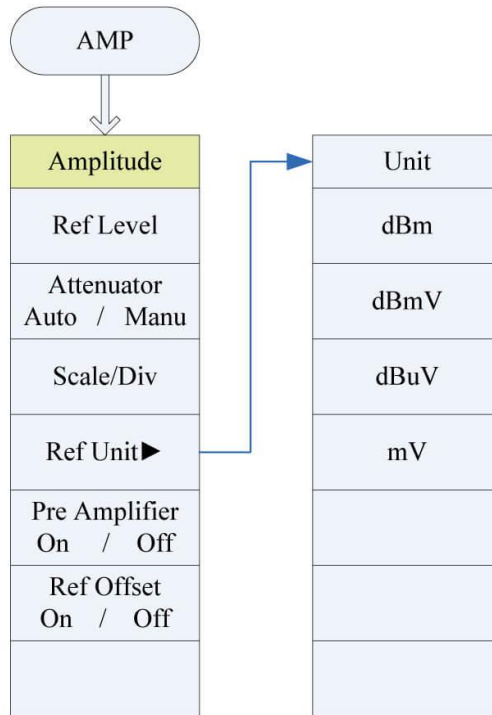

2.4.2 CPL

This key works for the same way in any measurements.

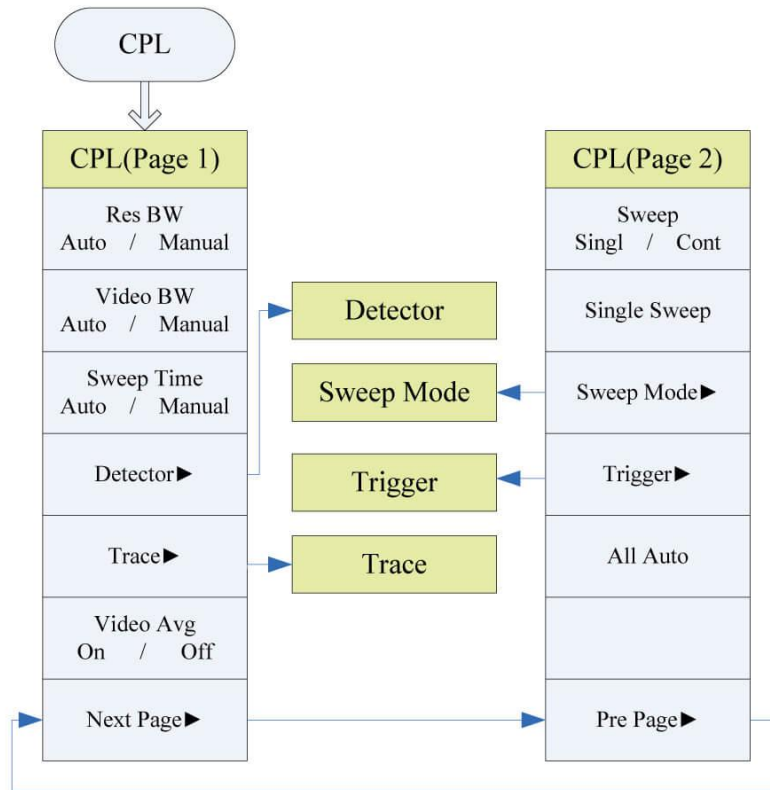

Detector	Trace	Trigger	Sweep Mode
Sample	Trace 1 2 3	Free Run	Fast
Posi-Peak	Clear Write	Video	Performance
Neg-Peak	View	Line	No FFT
Normal	Blank		
AVG	Max Hold		
	Min Hold		

2.4.3 FREQ

This key works for the different way in different measurements.

- Spectrum Analysis Mode -> Swept SA Type

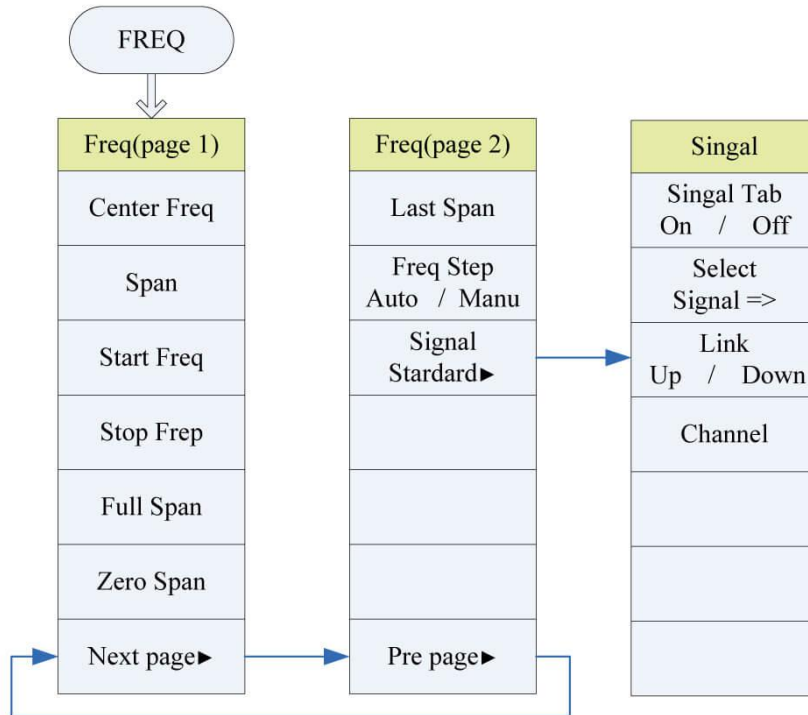

- Spectrum Analysis Mode -> Channel Power, ACP and Occupied Bandwidth Type

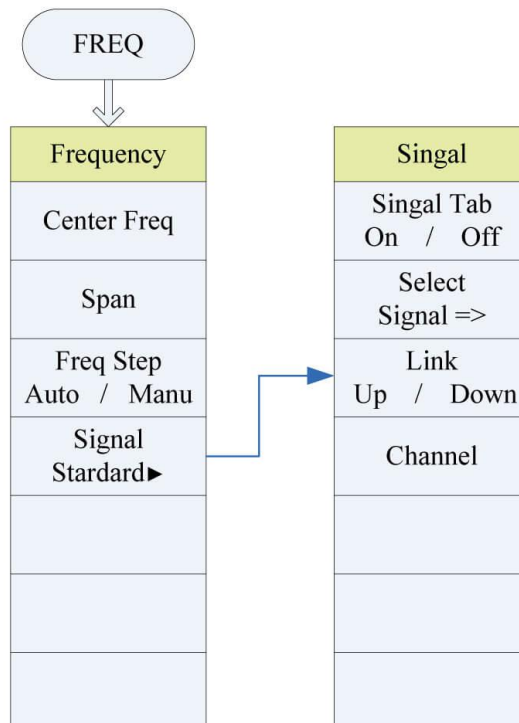

2.4.4 MARK

This key works for the different way in different measurements.

- Spectrum Analysis Mode -> Swept SA Type

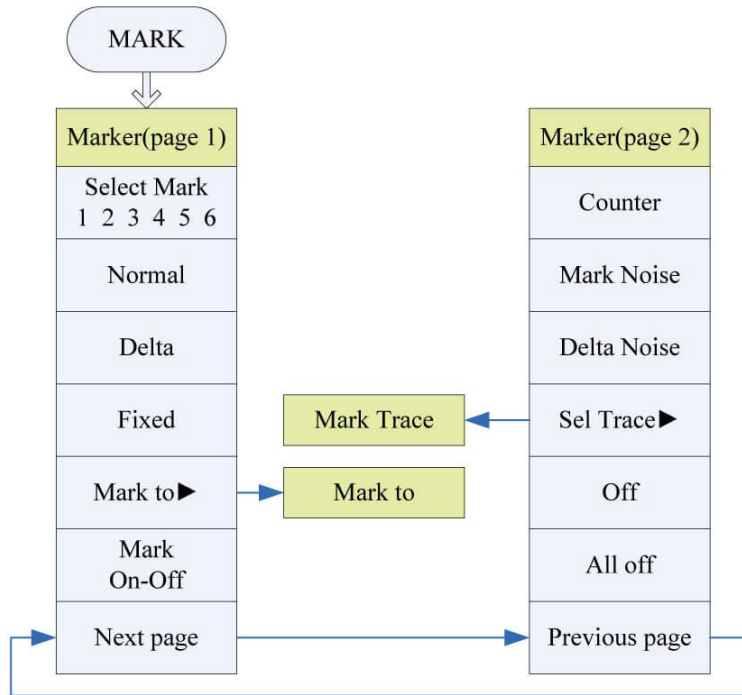

Marker to
Mark to Ref Level
Mark to Cent Freq

Mark Trace
Auto
1
2
3

- Spectrum Analysis Mode -> Channel Power, ACP and Occupied Bandwidth Type

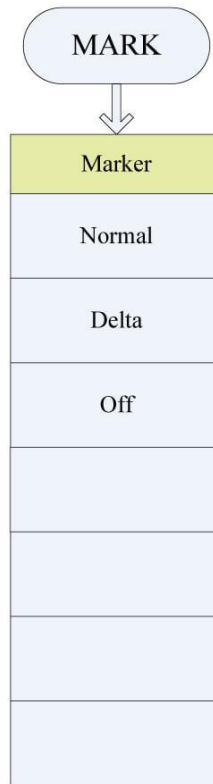

2.4.5 MEAS

This key works for the different way in different measurements.

- Spectrum Analysis Mode

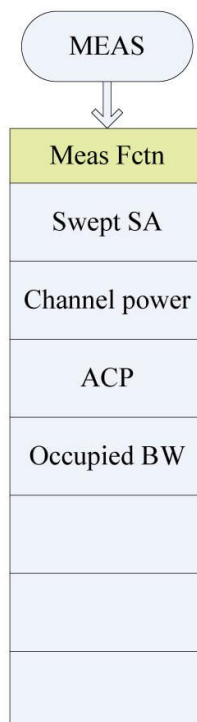

2.4.6 MEAS SETUP

This key works for the different way in different measurements.

- Spectrum Analysis Mode -> Swept SA Type (The first one)
- Spectrum Analysis Mode -> Channel Power Type (The second one)
- Spectrum Analysis Mode -> ACP Type (The third one)
- Spectrum Analysis Mode -> Occupied Bandwidth Type (The fourth one)

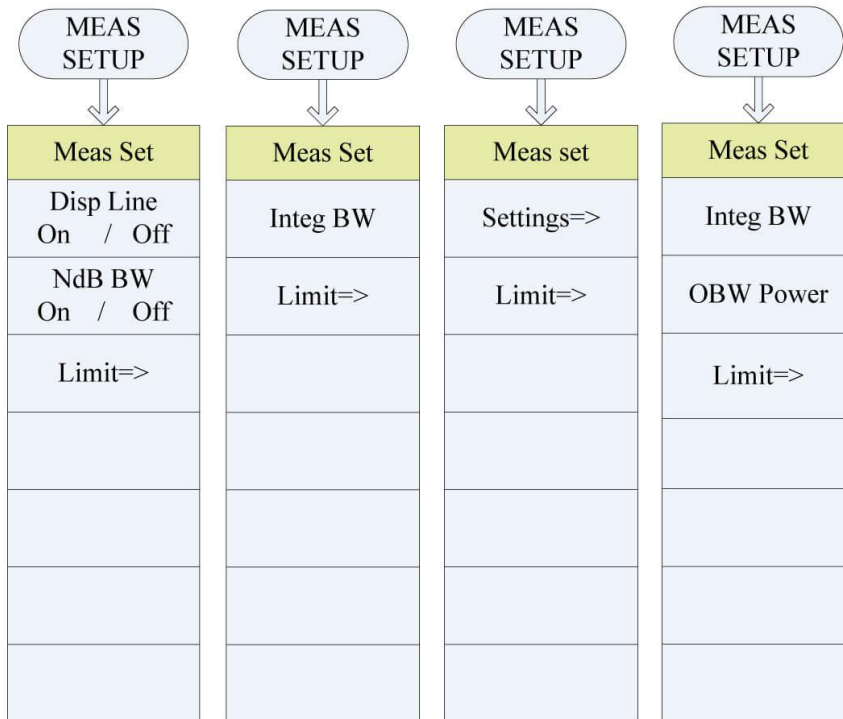

2.4.7 PEAK

This key works for the different way in different measurements.

- Spectrum Analysis Mode -> Swept SA Type

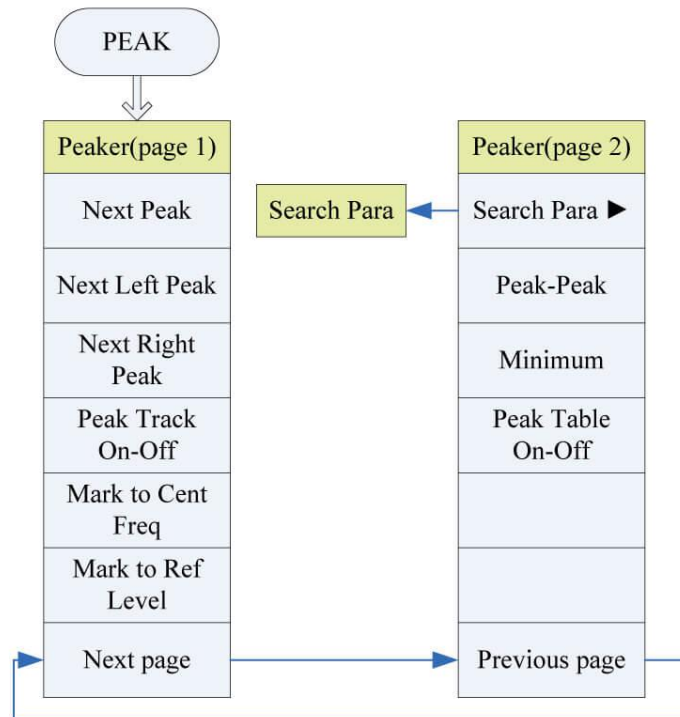

Search Para
Search Auto/Manual
Abs lev On-Off
Peak to Min
Search Dots
Peak to dots
Stab

➤ Spectrum Analysis Mode -> Channel Power, ACP and Occupied Bandwidth Type

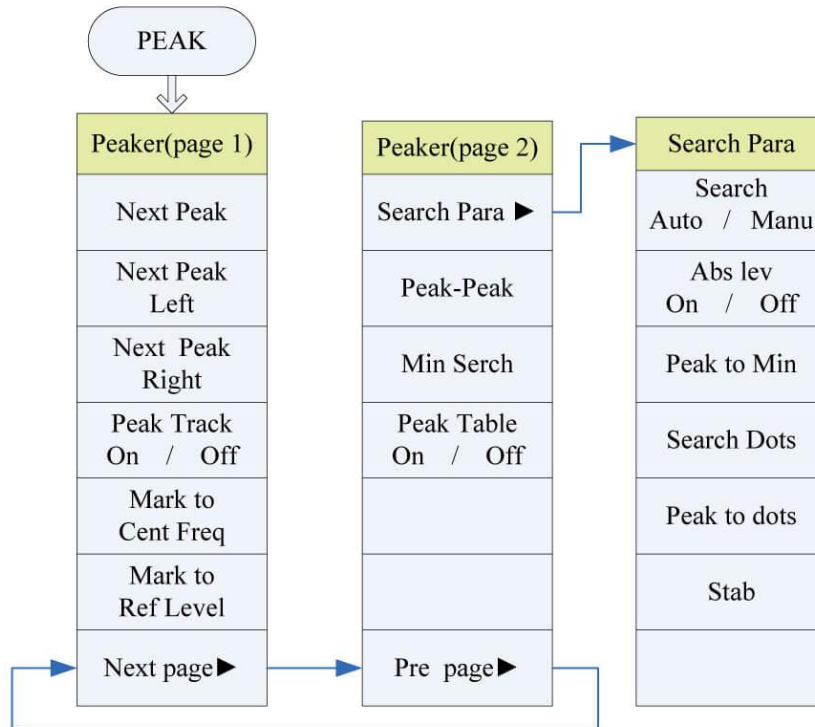

2.4.8 SYS

This key works for the same way in any measurements.

Beep Config	Calibrate	Language	Update
Beep Prompt On / Off	Cal Amp	English	Enter
Test Beep Prompt	Amp Corr On / Off		
Beep Alarm On / Off	Resp Corr On / Off		
Test Beep Alarm			
			Cancel

Chapter 3 Spectrum Measurement

Introduction

The main contents are:

- Swept SA function and usage
- Channel power function and usage
- Adjacent channel power function and usage
- Occupied BW function and usage

3.1 Measurement Type Selection

Pressing **MEAS** key, the submenu will appear. Well can switch the measurement type during swept SA, channel power, occupied bandwidth and ACP. The default one is the swept SA .

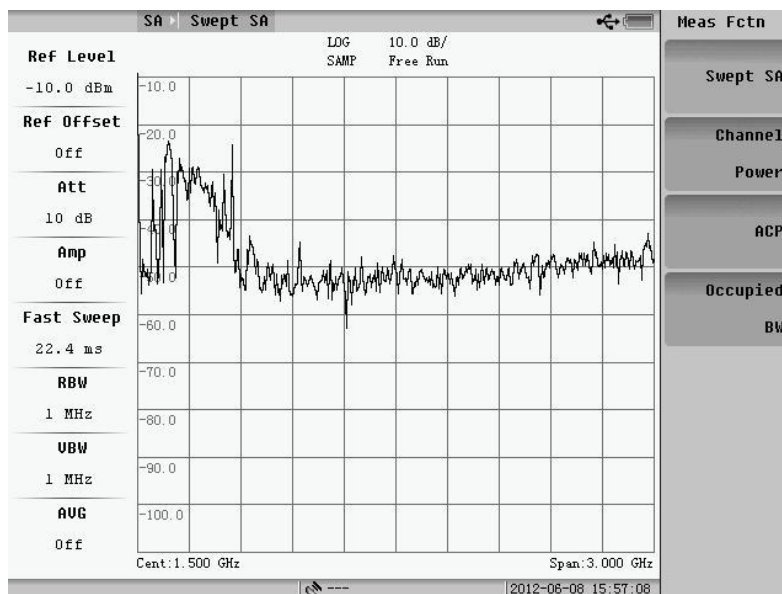

Fig.3.1 Measurement type selection

3.2 Swept SA

3.2.1 Basic measurement

The basic function of swept SA measurement is to get the frequency and amplitude characters of the input signal. The frequency and amplitude Keys which are used for spectrum measurement is on the bottom of panel keyboard.

1. Frequency

Pressing **FREQ** key, the submenu will appear(Fig.3.2), press “Next page”, and the second page of menu appear (Fig.3.3). User can set center frequency, start frequency, stop frequency and etc.

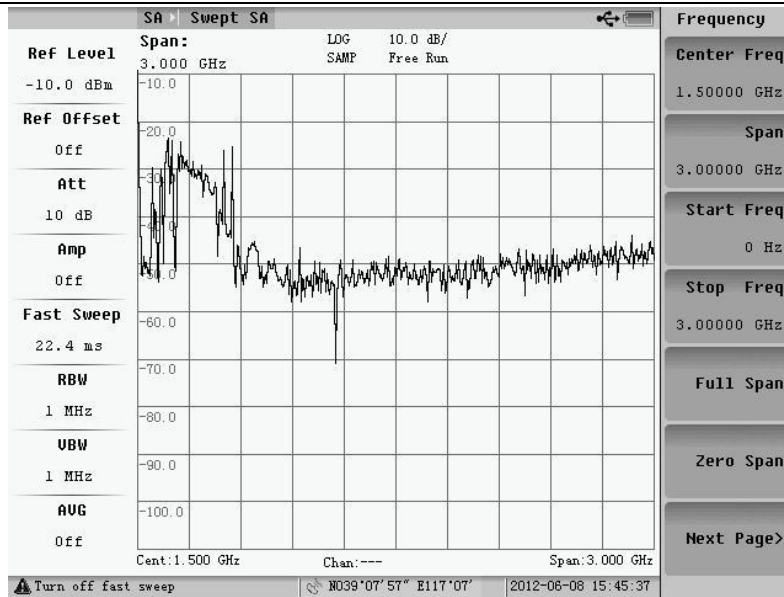

Fig.3.2 Frequency menu (page 1)

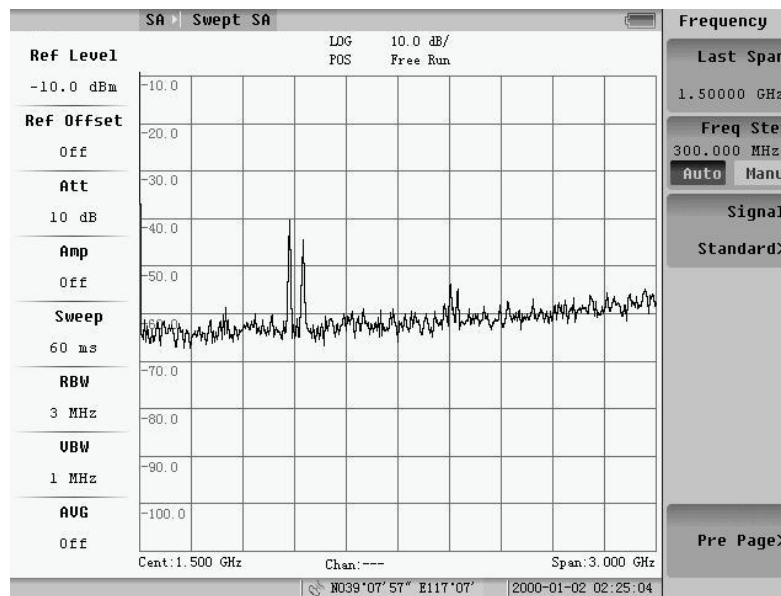

Fig.3.3 Frequency menu (page 2)

1) Center Frequency

Pressing “Center Freq” soft-key, user can change the current center frequency. There are three methods to input the frequency value:

- a. Directly input the number: Press the number keys, and the “Unit” menu will appear. Select the unit in this menu, and then user can finish the center frequency change.
 For example: If user want to set the center frequency to 20MHz, press the number key “2” and “0” and choose the “MHz”. The change of center frequency is finished.
- b. Press the “Up/Down” key: change by the step that is defined by “Freq Step”.
- c. Rotate the knob: change by a step of 1/420 of the span.

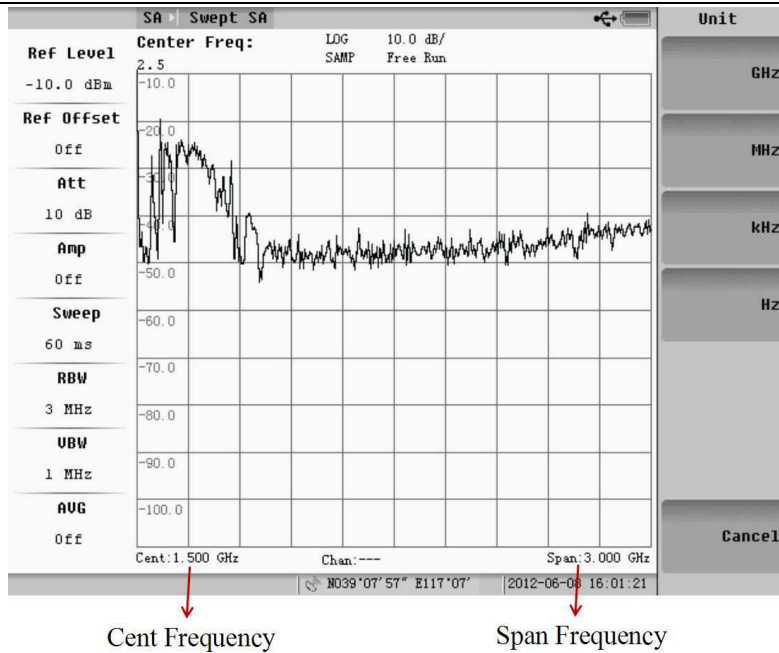

Fig.3.4 Cent frequency setting

NOTE:

1. In most parameter input cases, the information about the item and the input value will display on the screen.
2. The frequency range is from 0 to 3GHz, if the input is little/ more than 0Hz/ 3GHz it will be treated as 0Hz/ 3GHz.

2) Center Frequency

Pressing “Start Freq” soft-key, user can change the current center frequency. There are three methods to input the frequency value: Directly input the number. Press the “Up/Down” step key to change freq and rotate the knob. After setting start freq or stop freq, the former center freq and sweep span on the bottom of the screen will be replaced by start freq or stop freq.

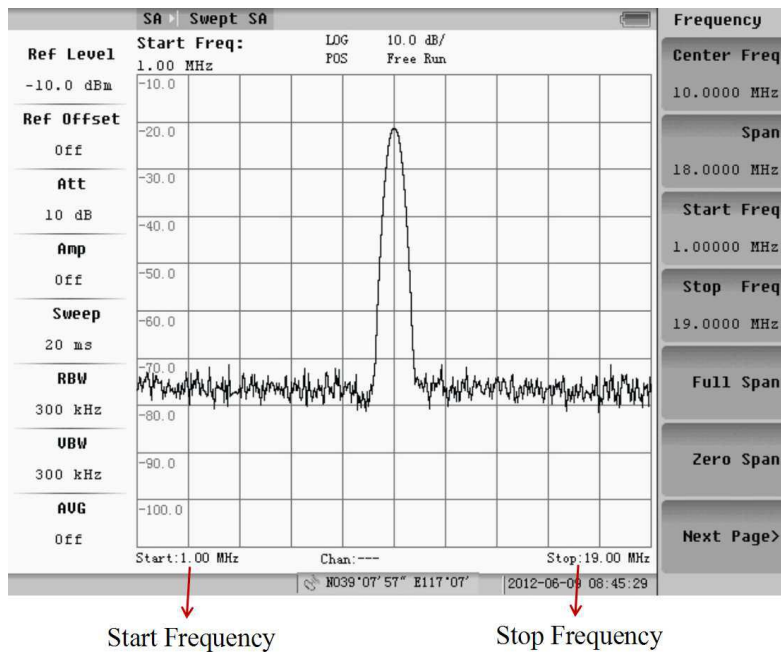

Fig.3.5 Start frequency setting

3) Stop Frequency

After pressing “Stop Freq” soft-key, user can change the stop frequency. There are three methods to change the stop frequency value: Directly input the number, press the “Up/Down” step key to change freq and rotate the knob.

4) Span

Span equals the stop frequency minus the start frequency. The span setting determines the horizontal-axis scale of the analyzer display.

The span range of the instrument is from 0Hz to 3000MHz. The larger span is set, the more signal can be viewed, the lower precision the measurement will get. On the contrary, the narrower span is set, the fewer signals can be viewed, the higher precision the measurement will get. So it is important to choose the appropriate span.

There are three methods to change the span: first is manually input; second is to press the Up/Down key which change step is 1,2,5, and the change sequence is 200Hz, 500Hz, 1kHz, 2kHz.... 3000MHz; last is to rotate the knob. The change step is 1/100 of the span.

NOTE:

1. When the **RBW** is set to “Manu”, too large span will cause the imprecision of the measurement. In such cases the system will give the prompt “UNCAL”. See also 3.2.1 --Band width.
2. Press “Up/Down” key cannot change the span to 0Hz.
3. When press “Up/Down” key to change span, if the current span is not one of the change sequence, it will be treated as the nearest lower one in the sequence. For example, 199Hz will be treated as 0Hz, if press “Up” key now, the span will become to 200Hz.

Fig.3.6 and Fig.3.7 show the comparison chart of narrow span and wide span.

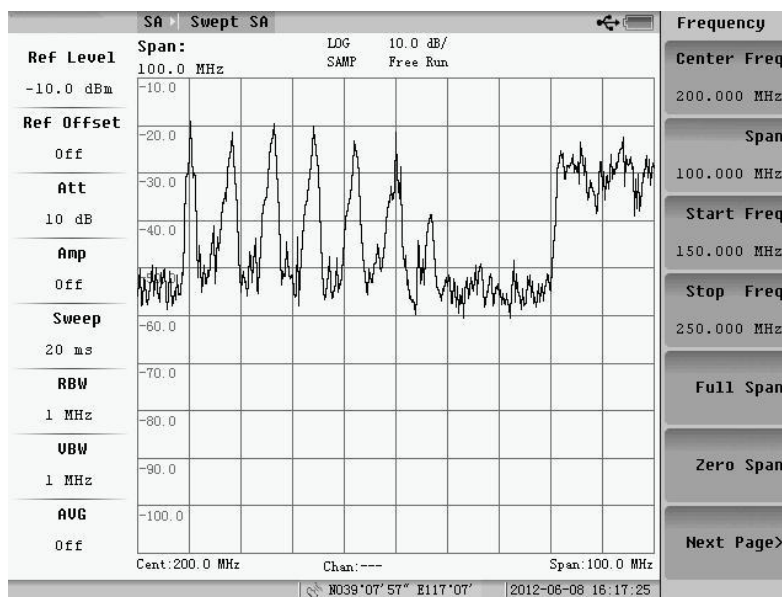

Fig.3.6 Narrow span frequency

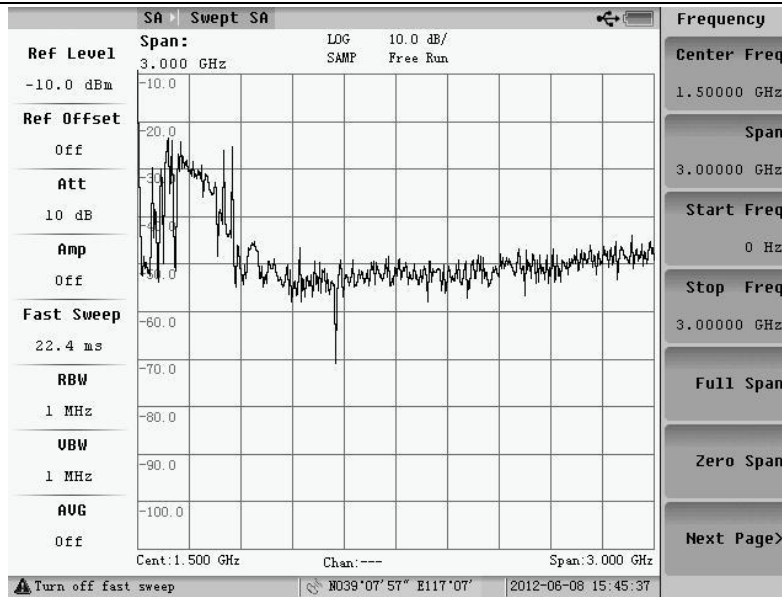

Fig.3.7 Wide span frequency

5) Full Span

Pressing this soft-key will change the span to 3000MHz.

6) Zero Span

Pressing this soft-key will change the span to 0Hz. This is the time domain information of selected frequency. Zero span is very useful to observe the characters of AM and FM signal and the signal of time domain.

7) Last Span

Change the current span back to last span. User can directly change between current span and last span by pressing this soft-key in order to view the difference of the signal display between these two conditions.

8) Frequency Step

The default value of “Freq Step” is 1/10 of the span. After pressing the “Freq Step” soft-key and setting it to “Manu”, user can input the frequency step. There are three methods to change the freq step: first is manually input, second is to press the Up/Down key, last step is to rotate the knob.

9) Signal Standard

Press “Signal Standard” soft-key, and the submenu will appear, which is shown as Fig.3.8.

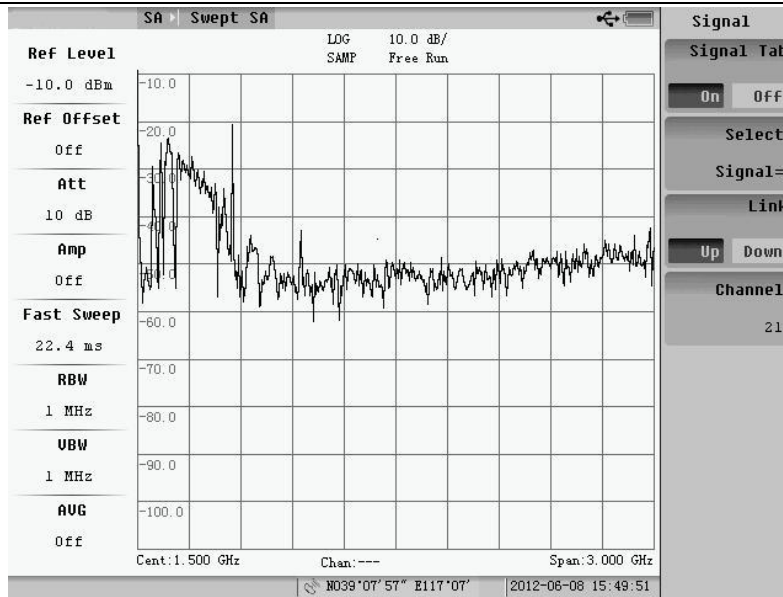

Fig.3.8 Signal standard setting

After pressing the “Signal Tab” soft-key and setting it to “On”, we can use the sub-menu .By pressing the “Select Signal” soft-keys the dialog box shown as Fig.3.9 will appear.

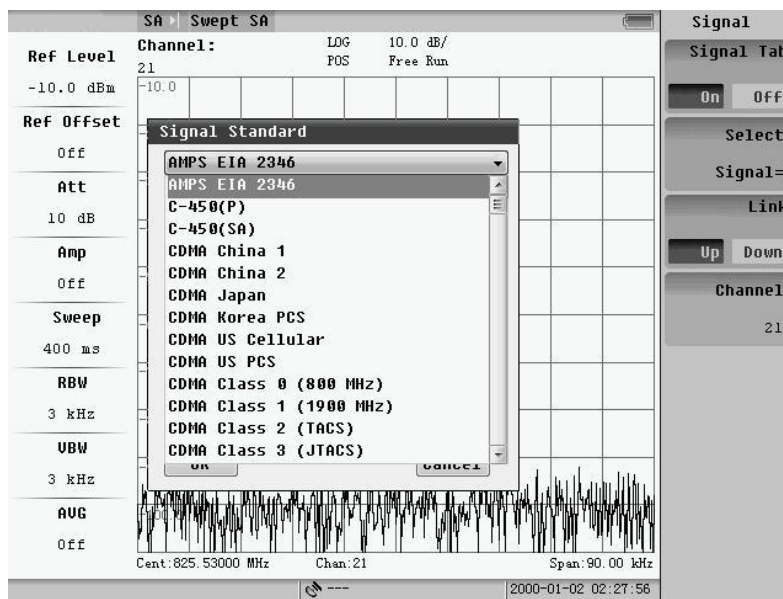

Fig.3.9 Signal standard dialog box

By up/down key or knob, we can choose the signal standard. The center frequency will be set by inputting the frequency channel number. There are three methods to change the freq channel: first is manually input, second is to press the Up/Down key, and the last step is to rotate the knob.

2. Amplitude

Pressing **AMPTD** key, the submenu will appear, which is shown as Fig.3.10.

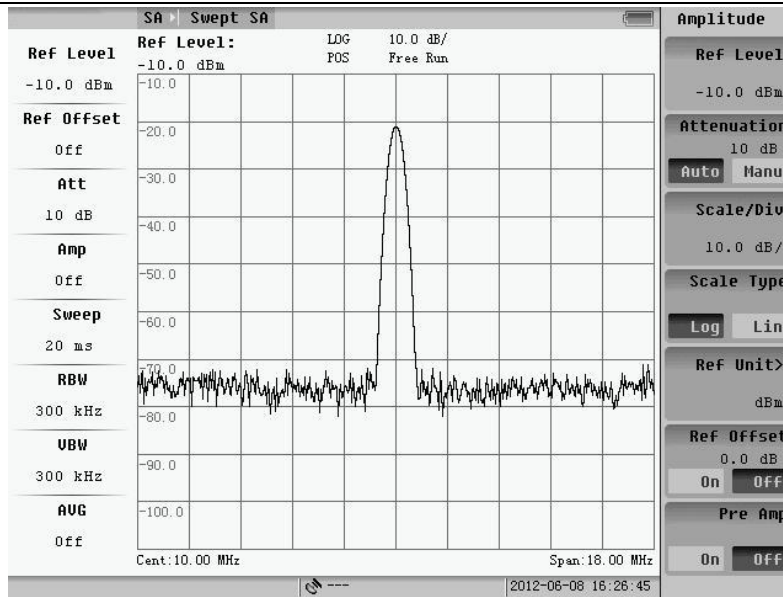

Fig.3.10 Amplitude menu

1) Reference Level

Reference level is display on the up-left of the screen, which is signed as “Ref”. The default value of “Ref” is 98.8dBμV.

NOTE: The smallest value of reference value is changed according to the different attenuator setting. The details will be introduced in next section.

User can set the unit of reference to dBm, dBmV, dBμV, mV, V, μV or nV in the instrument. The exchange formula between different units is shown as following table.

Table3.1 Exchange formula from other units to dBm

Formula	Source value	New value
$\text{dBm} = \text{dB}\mu\text{V} - 108.8$	68.8 dBμV	-40 dBm
$\text{dBm} = \text{dBmV} - 48.8$	8.8 dBmV	-40 dBm
$\text{dBm} = 20 \cdot \log(\text{mV}) - 48.8$	2.778 mV	-40 dBm

Table 3.1 only lists the formula to dBm, you can deduce the others.

Three methods to change reference level:

- Input by number key: After inputting the number, the unit menu will appear. Choose the unit user need to finish the reference level input.
- Input by “Up/Down” cursor: The change step of this method is the amplitude that one grid corresponds to.
- Input by Knob. The change step of this method is the amplitude that 1/10 grid correspond to.

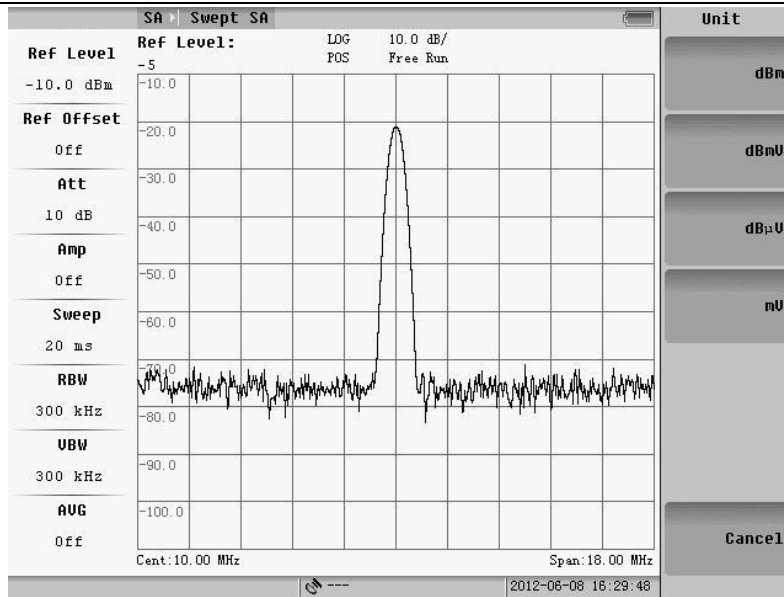

Fig.3.11 Reference level setting

2) Attenuator

Attenuator is an important part of the instrument. It can reduce the signal distortion by attenuating the power level of the mixer input signal. The value of attenuator is from 0 to 55dB with 5dB step, the default value is 10dB.

Increasing the value of attenuator can diminish the mixer distortion, but the base noise of the system will increase too that will reduce the range of measurable signal. In auto mode, the system can automatically provide a suitable value of attenuator.

NOTE: The amplitude of signal input to mixer should be less than -20dBm, otherwise the signal may be distorted.

If users wants to set the attenuator manually, user should firstly set the “Atten” softkey as figure 3.7 to “Manu” and then input the value by number keys, “Up/Down” key or the knob. By “Up/Down” cursor or the knob, the change step is 5dB and cannot be set attenuator to 0dB.

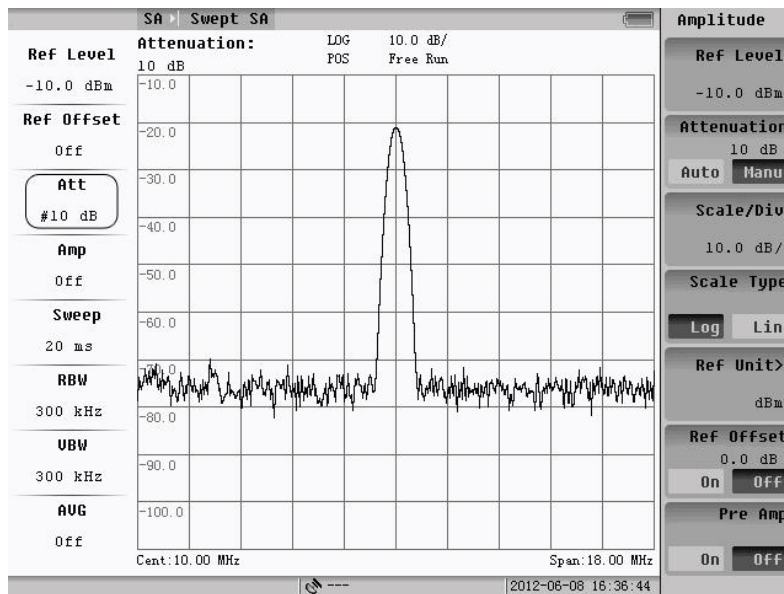

Fig.3.12 Attenuator is Manu setting mode

3) Scale Log/Line

In “Log” state, the difference of Y-coordinate has the direct ratio to Δ dB, while in line state it has the direct ratio to

voltage difference ΔV . In most cases, the instrument is in logarithm state, but in some special cases (for example when measuring the modulation degree of AM), the line state is the better choice.

The common used unit in logarithmic state is dBm, dB μ V and dBmV. The wave will not change with the change of unit.

The common used unit in line state is mV, V, μ V or nV. The wave will not change with the change of unit, too.

Fig.3.12 shows the difference measure results of the same signal one in “Log” state and the other in “Line” state.

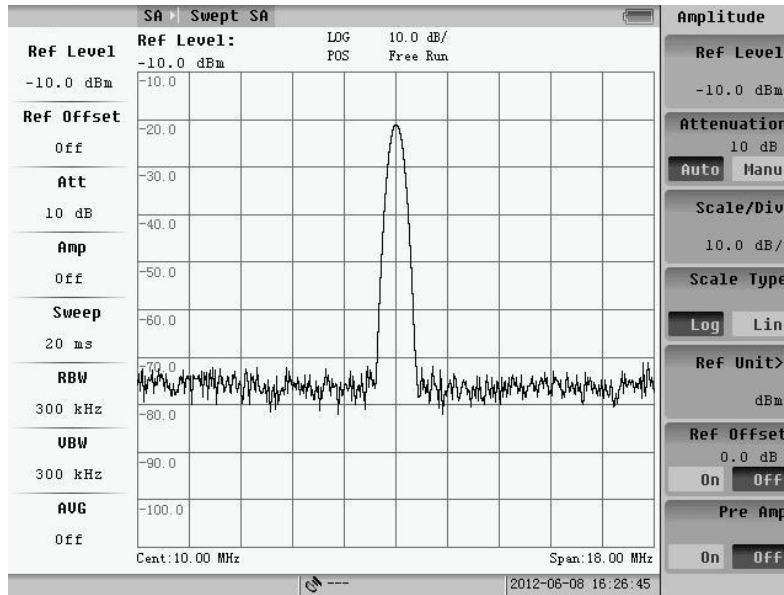

Fig.3.13 Logarithmic state and Reference Level is -10dBm

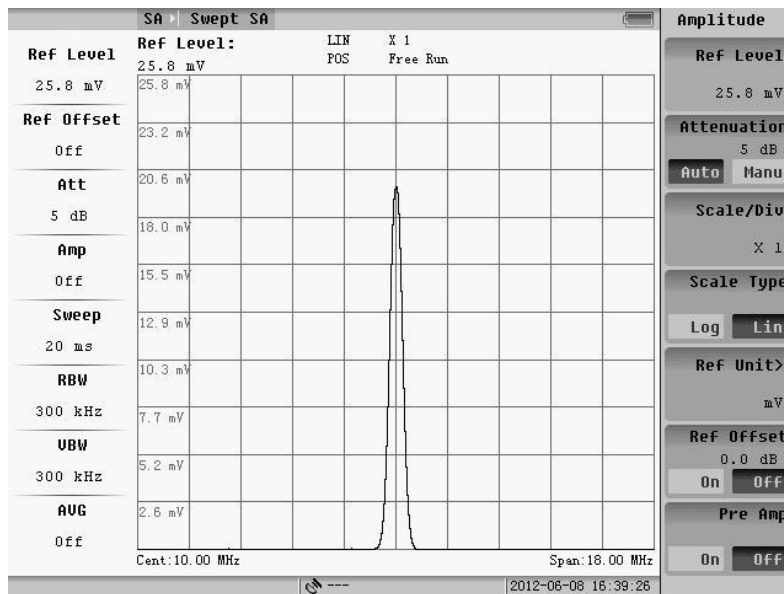

Fig.3.14 Line state and Reference Level is 25.8mV

4) Unit

Pressing the “Ref Units” soft-key, the submenu will appear:

Choose the unit needed and then press the **RETURN** key to cancel the setting.

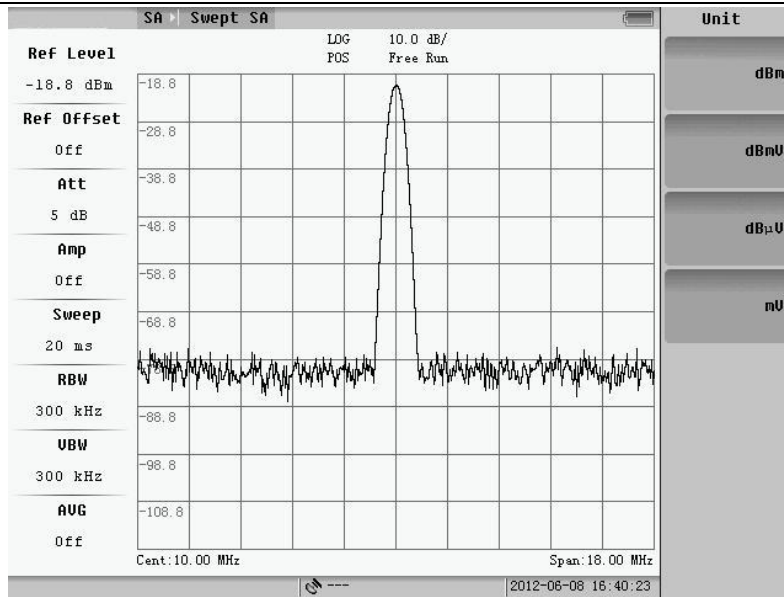

Fig.3.15 Amplitude Unit

NOTE: The change of unit will not cause the change of “Log/Line” state.

5) Scale/Div

The scale/div is displayed on the upside of the screen.

In logarithm state: the default value is 10dB/grid. After pressing “Scale/Div” soft-key user can enter the integer number from 1 to 40 or decimal number from 0.1 to 0.9 to change the scale to the state wanted. The scale/div can be changed by “Up/Down” cursor or by knob too.

In line State: The “scale/div” state is shown as $\times n$. After pressing “Scale/Div” soft-key, the submenu of it will appear. User can choose $\times 1$, $\times 2$, $\times 5$ or $\times 10$ in this submenu. $1/n$ is the ratio of voltage difference between the lowest level displayed on the screen and reference level. For example when reference level is 1mV, if the Scale/Div is $\times 1$, the lowest voltage display on the screen is 0mV, while if the Scale/Div is $\times 2$, the lowest voltage display on the screen will be 0.5mV.

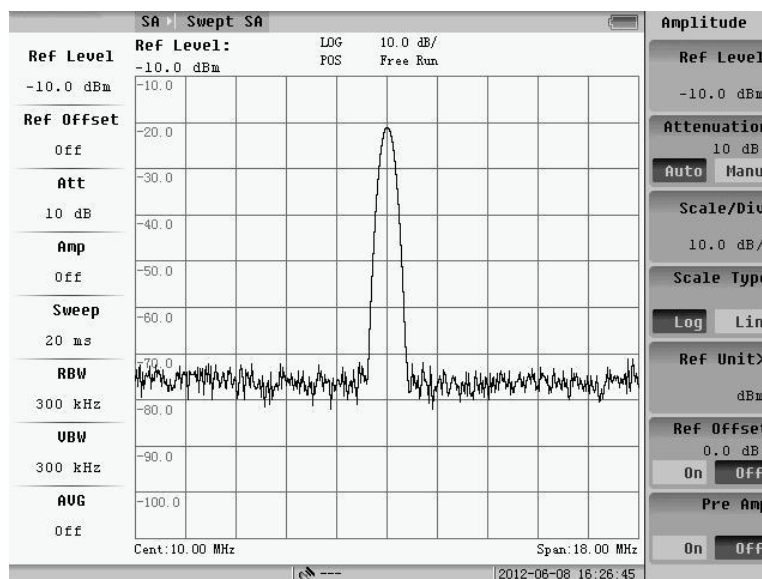

Fig.3.16 Scale is 10 dB/ in logarithmic state (default value)

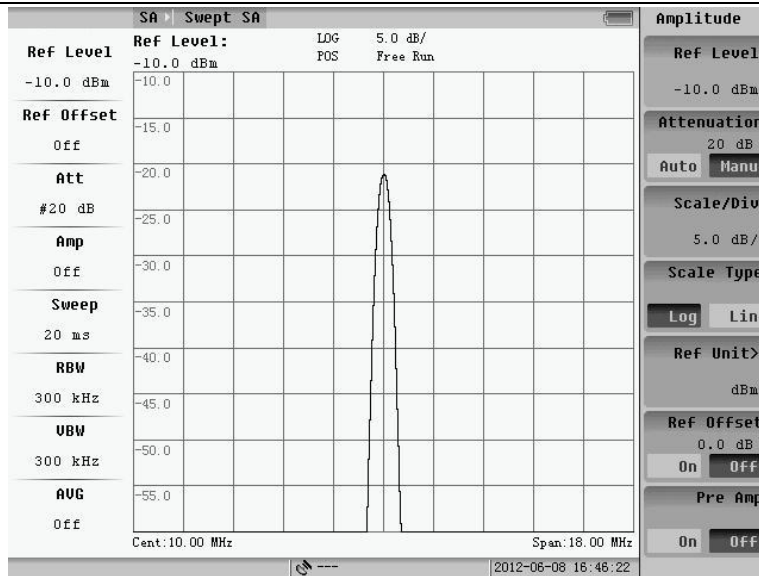

Fig.3.17 Scale is 5 dB/ in logarithmic state

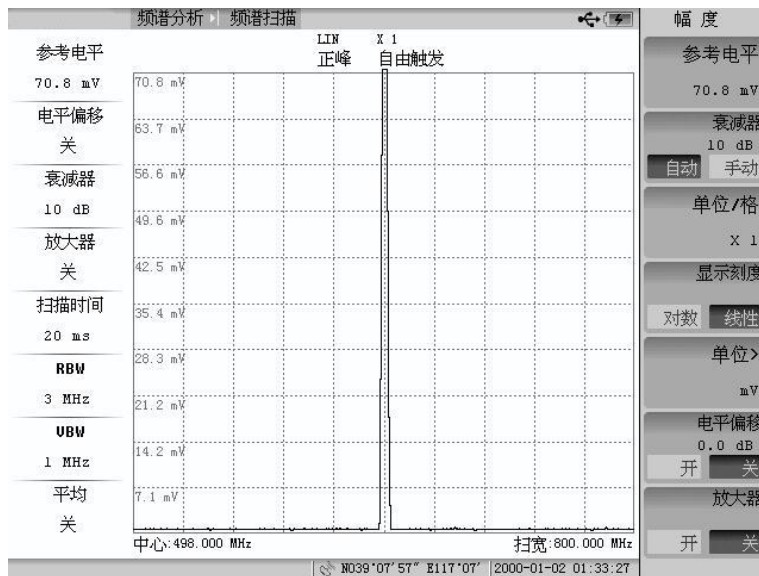

Fig.3.18 Scale is $\times 1$ in line state (default value)

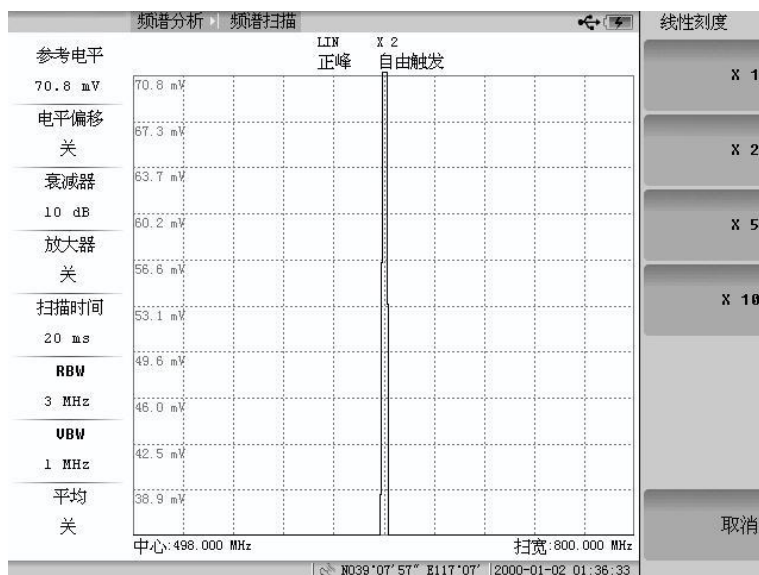

Fig.3.19 Scale is $\times 2$ in line state

No matter in “Log” or “Line” state, the change of “Scale/Div” will not change the measurement value.

Ref Offset:

“Ref Offset” indicates the reference offset level. For example, if the “Ref Offset” is set to “On” state and its’ level is set to 25dB, then the reference level and the marker level that display on the screen will be changed shown as Fig.3.20 and 3.21.

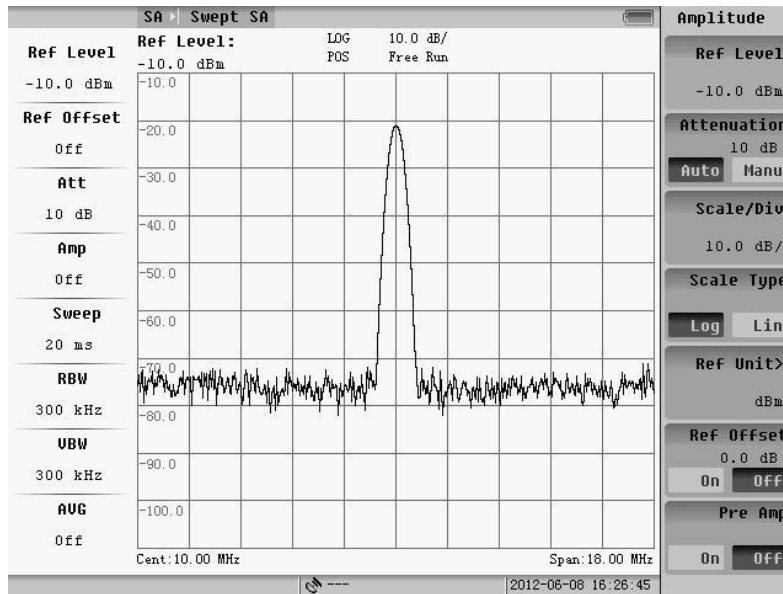

Fig.3.20 Ref Offset is Off

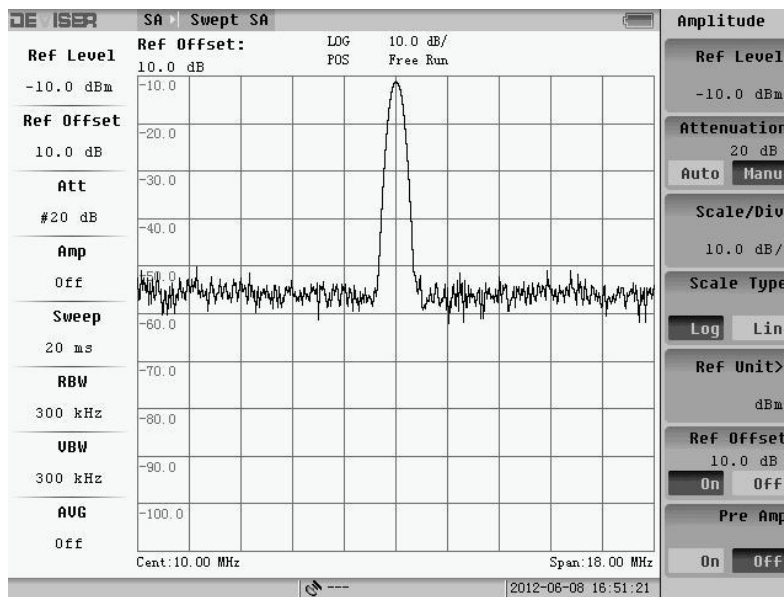

Fig.3.21 Ref Offset is 10 dB

6) Pre Amplifier

There is a preamplifier in S5800E series. By pressing “Pre Amp” soft-key, user can set the “On/Off” state of this amplifier according to the signal intensity.

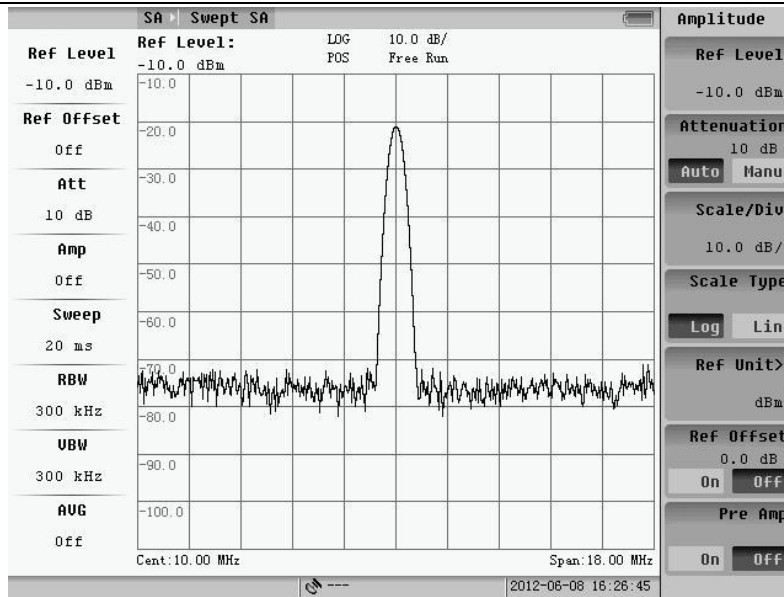

Fig.3.22 Pre Amplifier is off

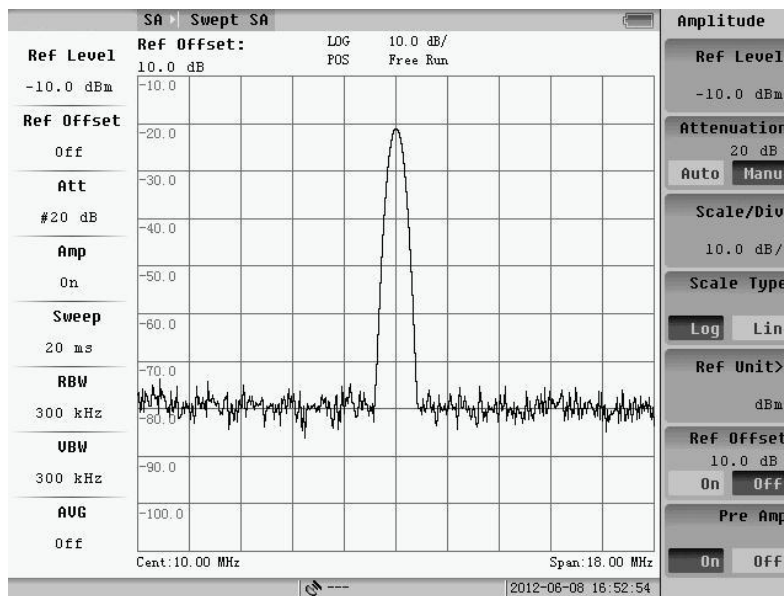

Fig.3.23 Pre Amplifier is on

3.2.2 Basic parameters setting

Basic parameters of Swept SA measurement refer to RBW, VBW, sweep mode, sweep time, trig mode and etc. The **CPL** keys about these settings are located on the right top of front panel. Pressing soft-key, the follow menu will appear:

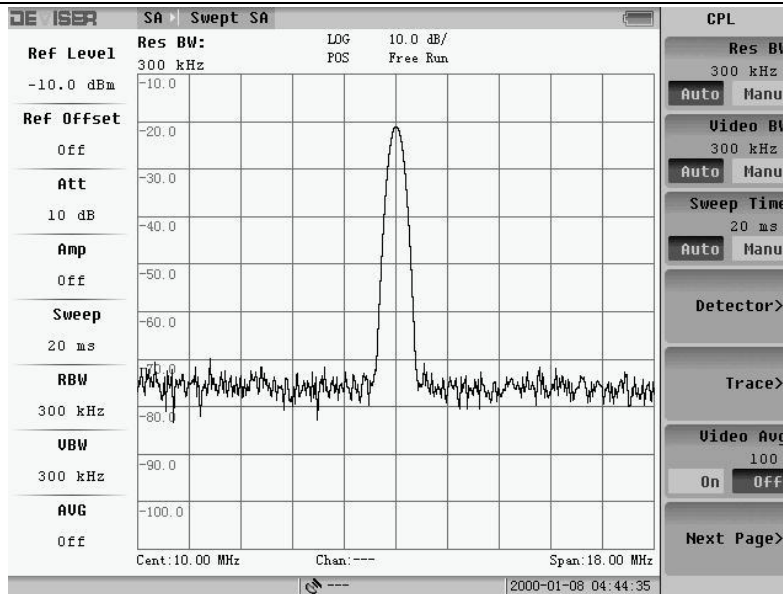

Fig.3.24 Basic parameters menu (page 1)

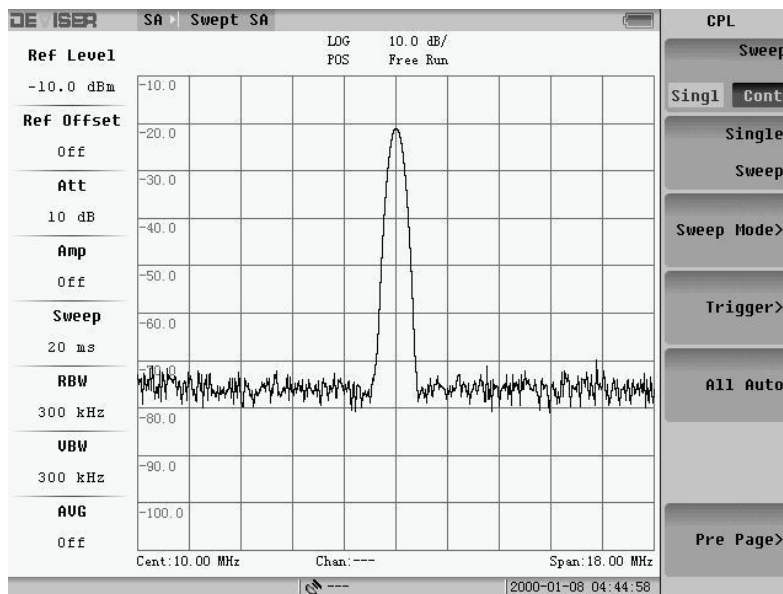

Fig.3.25 Basic parameters menu (page 2)

1. BW Set

1) RBW

Resolution bandwidth (RBW) refers to the IF filter bandwidth of spectrum analyzer. RBW defines the smallest frequency difference of two adjacent signals that can be distinguished by the spectrum analyzer. So the narrower the RBW is set, the higher precision the spectrum has. But it need more establish time with narrow RBW. If the sweep time cannot fulfill the requirement of RBW, the system will give the prompt “UNCAL”.

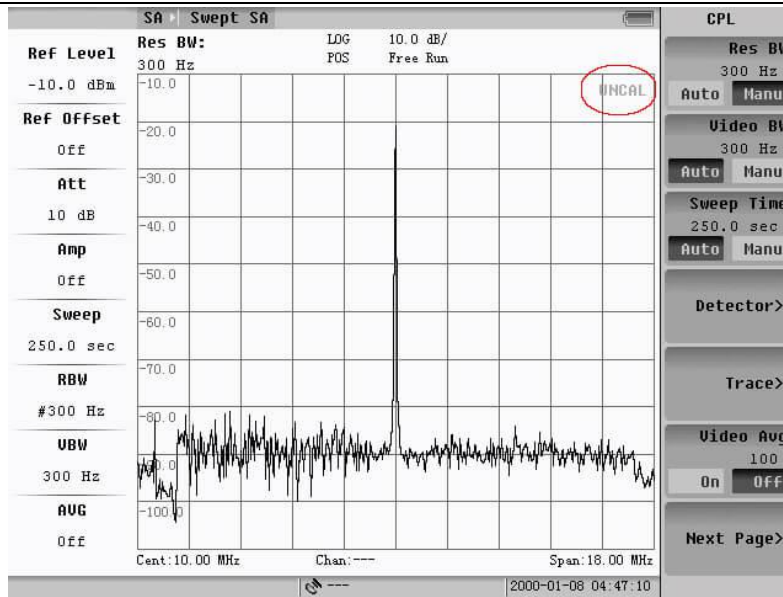

Fig.3.26 Marked is “UNCAL”

The RBW can be changed from 1kHz to 3MHz, taking the step of 1 and 3. After setting the “Res BW” to “Manu” state, user can change the RBW by inputting the number, pressing the “Up/Down” cursor or rotating the knob. The symbol of “#” is showed on the left parameter table.

2) VBW

Video bandwidth (VBW) is the lower pass filter after the IF filter which can make the display trace noise more smoothly. It is very useful to detect the signal whose level is near to the noise. To improve the filter’s effect, user should manually set the VBW to smaller than 1/10 of the RBW. When VBW is set to “Auto”, the VBW will change with RBW. The VBW filter need establishing time too and the smaller its value is, the more time it needs.

In Fig.3.27, there is a “#VBW” on the screen, in which “#” indicates that VBW parameter is in “Manu” state now. The same # will use to indicate the “Manu” of RBW, sweep time, attenuator too.

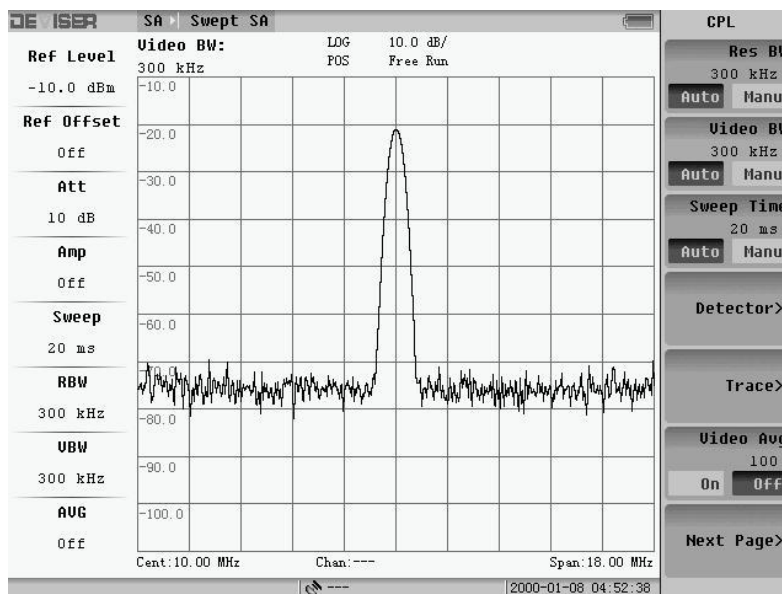

Fig.3.27 Wide VBW

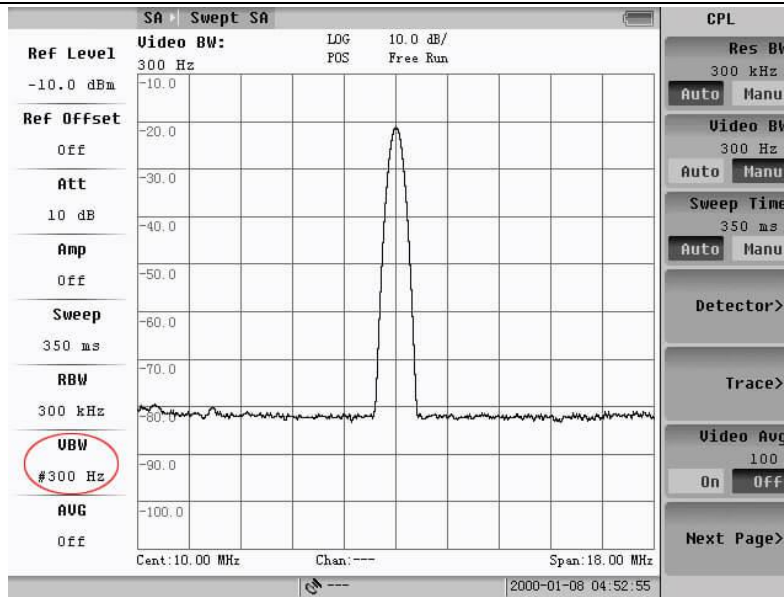

Fig.3.28 Narrow VBW

3) Video Average

Set the “Video Avg” to “On”, then the spectrum will calculate the average value of current trace and previous traces values. The default state of “Video Avg” is “Off”.

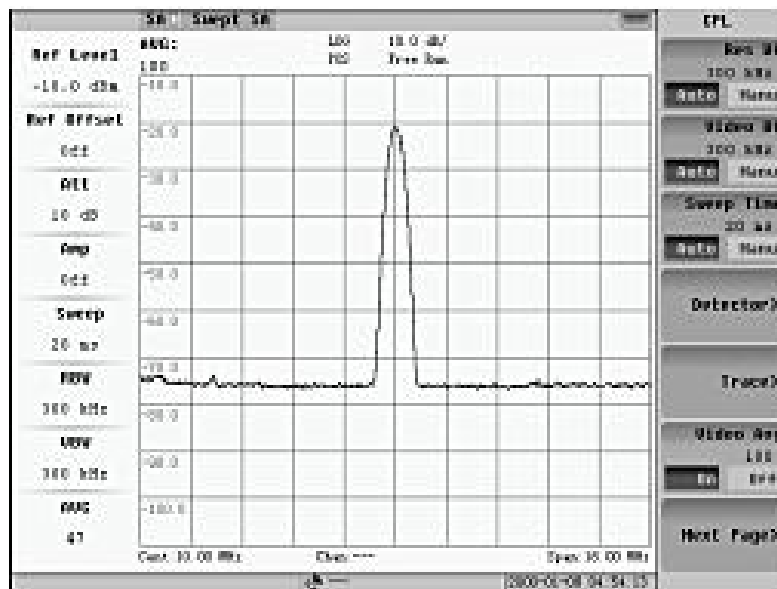

Fig.3.29 Video average on

Turn on the “Video Avg”. It can smoothly display trace as VBW but the sweep time will not be increased with it. When “Video Avg” set “On”, the default detector mode will be changed to “Sample” mode automatically.

The default average time is 100. Press number key after setting the “Video Avg” to “On” that can change the average time.

2. Sweep Time, Sweep Mode

1) Sweep time

Sweep time depends on span, RBW and VBW. If the sweep time can't fulfill the requirement of span, RBW and VBW, the system will give the prompt “UNCAL”. User can set the “Sweep Time” to “Manu” and input the wanted time.

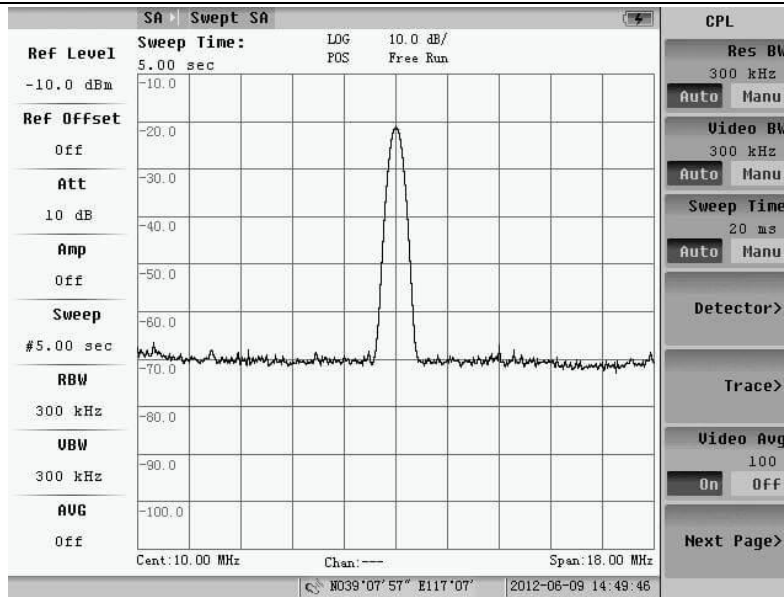

Fig.3.30 Sweep time is 5s

2) Sweep type

There are two sweep modes; one is continuous (Cont) and the other is single (Sigl). The default mode is continuous mode. If user wants to set the sweep mode to single mode, user can set the “Sweep” soft-key in Fig.3.18 to “Sigl” state or press the “Single Sweep” sub-key to activate a single sweep at the same time the menu shown as Fig.3.31 will appear.

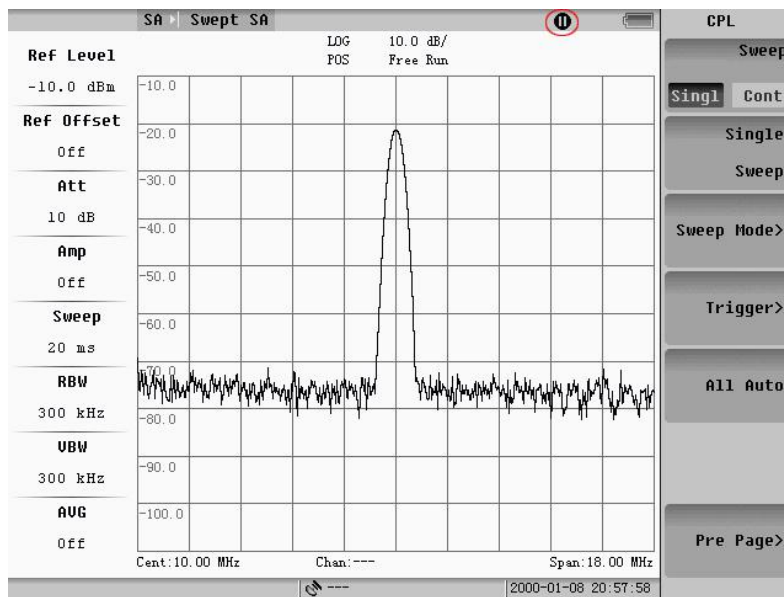

Fig.3.31 Single sweep

Pressing “Single Sweep” sub-key again can activate another single sweep. If user wants to change the state to “Cont”, he/she can select the “Sweep” soft-key and set the state of it to “Cont”.

3) Sweep mode

Pressing the “Sweep Mode” sub-key, we can select the sweep type during Fast, Performance and No FFT.

The sweep type is showed in the left parameter’s position.

A Paroxysmal signal can be captured accurately in the fast sweep type. If the frequency span is 100 MHz, the sweep time is 2.9ms in the fast sweep type, as it will be 20 ms in the No FFT type. In fast sweep type, the maximum span is

100MHz and the minimum span is 1MHz. The maximum RBW is 1MHz and the minimum RBW is 30kHz.

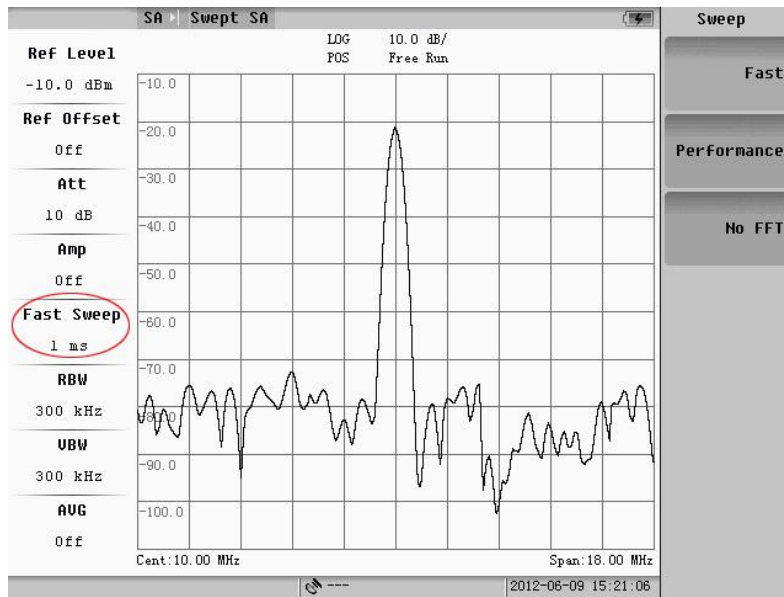

Fig.3.32 Fast sweep mode

The veracity and sweep speed of measurement in the performance sweep type is intervenient between the fast and No FFT type.

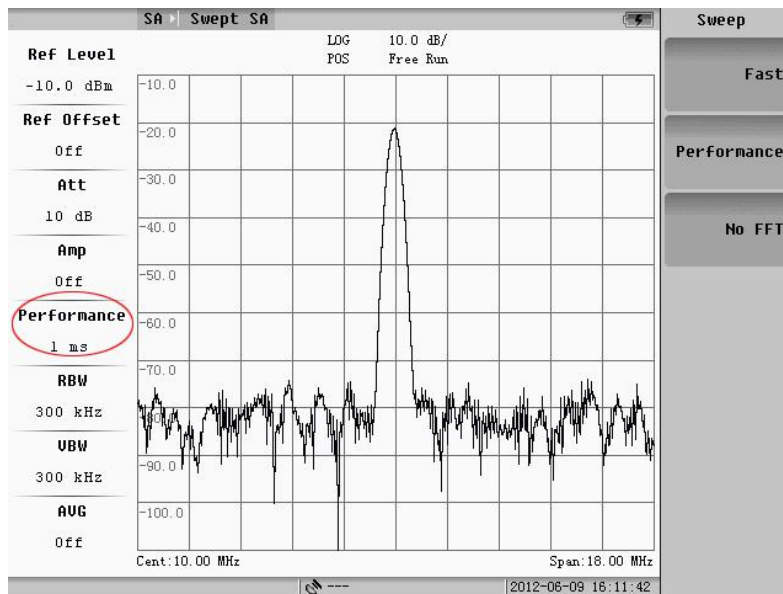

Fig.3.33 Performance sweep mode

There is sweep time showed in the left parameter's position as the No FFT sweep type.

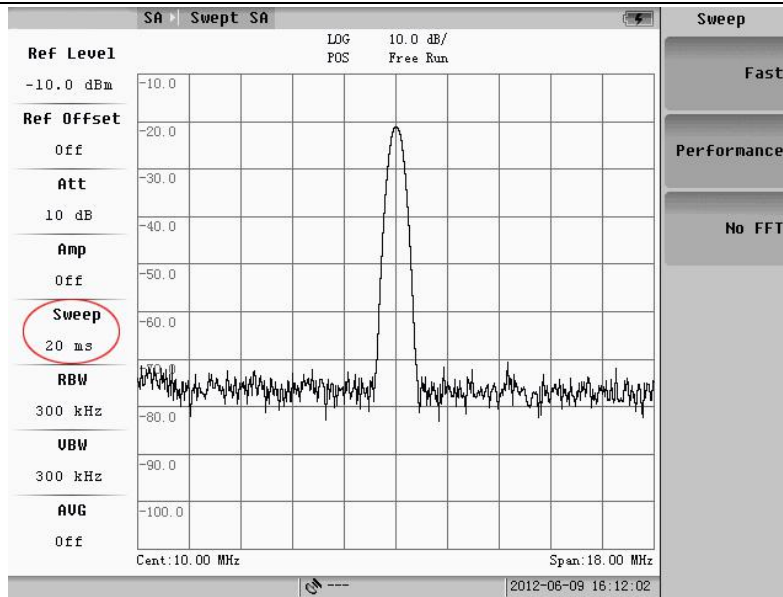

Fig.3.34 No FFT mode

3. Multi-trace Function

Pressing Trace sub-key, the follow menu will appear:

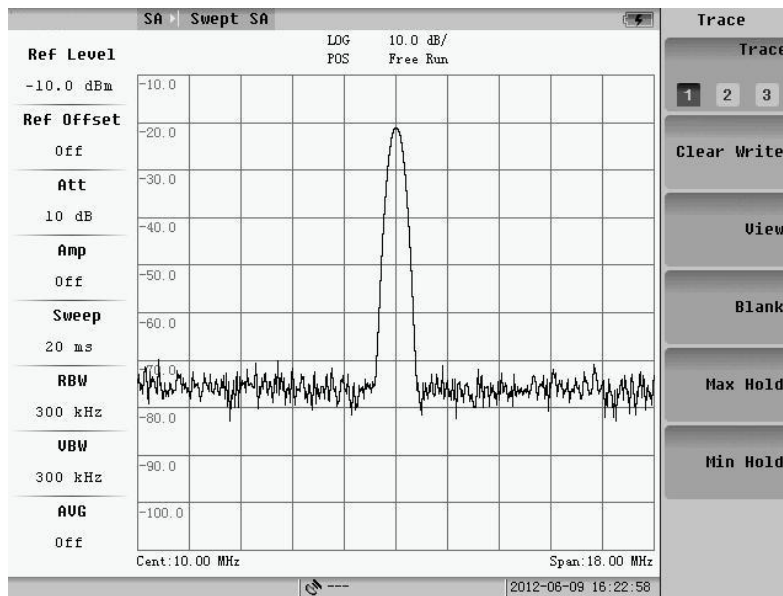

Fig.3.35 Trace menu

1) Trace Selection

There are three traces that user can choose 1, 2 or 3. User can switch during these trace by press “Trace” soft-key. What are called three traces are the different waves of the same input that only were viewed in different time and different parameter settings. Three traces are showed by different color lines.

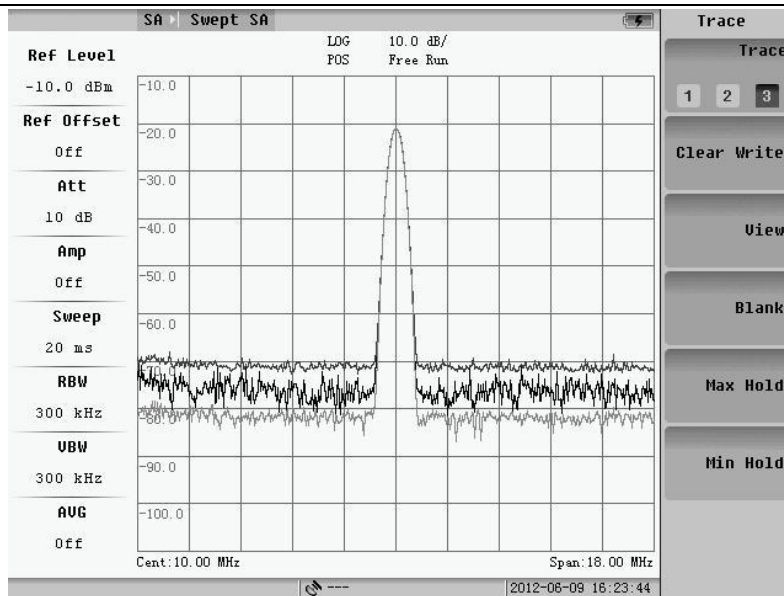

Fig.3.36 Three traces

2) Write

Write is the default state of all the three trace. In this mode the wave is continuously refreshed.

3) View

Pressing “View” soft-key, the current active trace will be hold. Change to other trace and user can see the changes of the wave with the different parameter settings. Fig.3.30 gives an example of “View” soft-key. The trace A is in the “View” state and the reference level of it is 68.8 dB μ V. When change the reference to 88.8 dB μ V, only the trace in “Write” Mode changed, while trace “A” keeps unchanged.

4) Blank

Erase the display of the selected trace.

5) Max Hold

“Max Hold” mode is similar to “Write” Mode, but the wave shown on the screen will keep the largest value comparing with the history after “Max Hold” mode is selected.

6) Min Hold

“Min Hold” is similar to “Max Hold”, it saves the level value of the lowest points.

4. Detector Mode

The S5800E series have 5 detector modes.

1) Sample

Detector sample the data point in the middle time of VBW filter’s output of each sweep point, and displayed it. It is more suitable to view the noise.

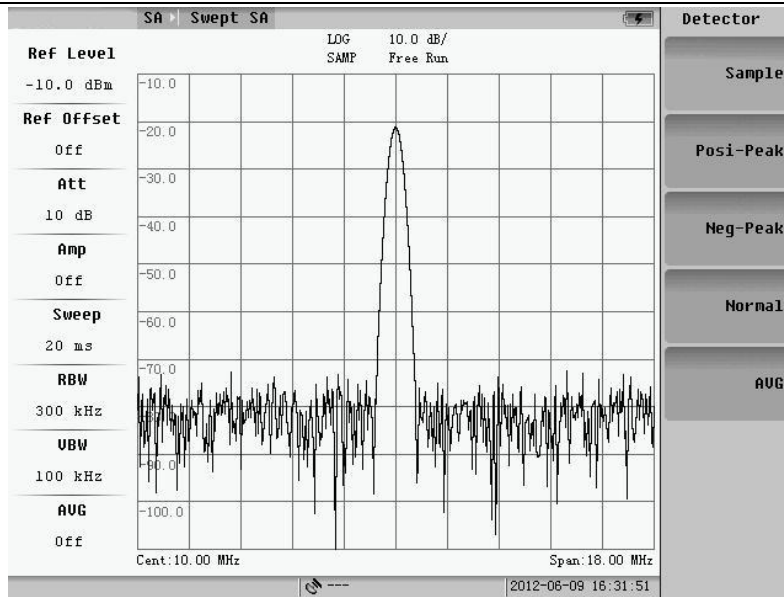

Fig.3.37 Sample detector mode

2) Positive-Peak

Detector sample the positive value of VBW filter output of each sweep point, and display it. If the sweep time is long enough, this detector can put out the maximum envelop of the modulated signal.

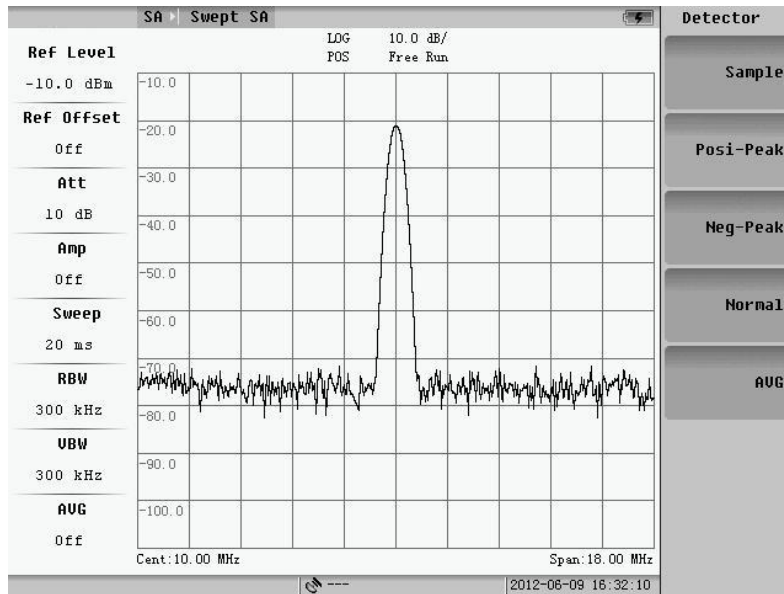

Fig.3.38 Positive-peak detector mode

3) Negative-Peak

This detector is opposite to “Posi-Peak” detector. The output of it is the minimum envelop of the signal.

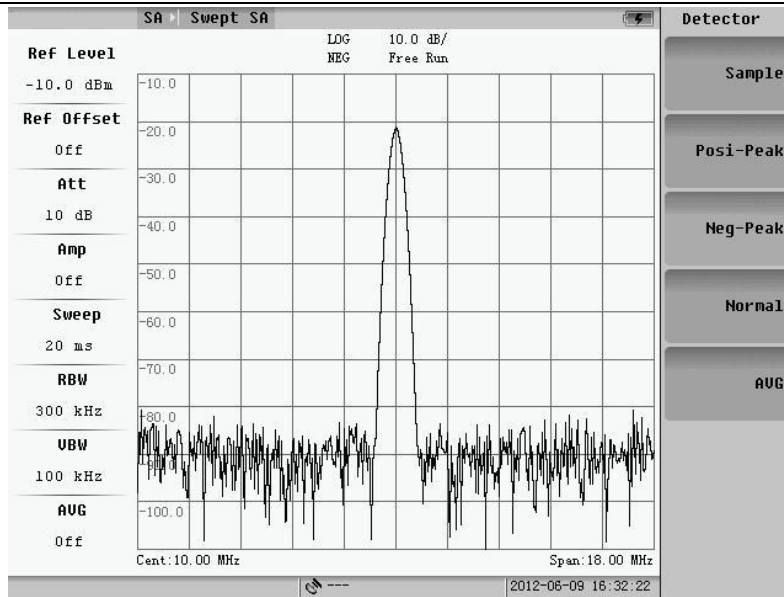

Fig.3.39 Negative-peak detector mode

4) Normal

This detector continuously samples the positive-peak value of the signal, while alternately samples the positive and the negative peak value of the noise and display it.

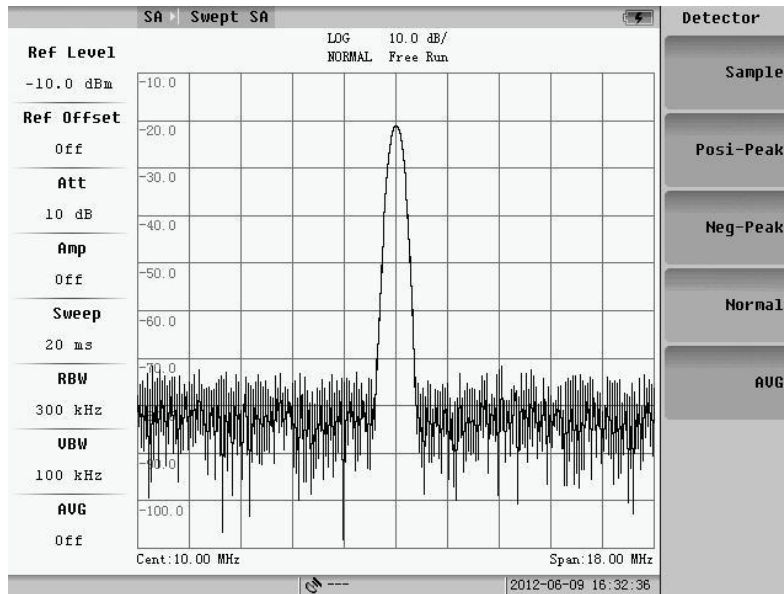

Fig.3.40 Normal detector mode

5) Average

The output as this detector mode is the average value of all detected values for each sweep point.

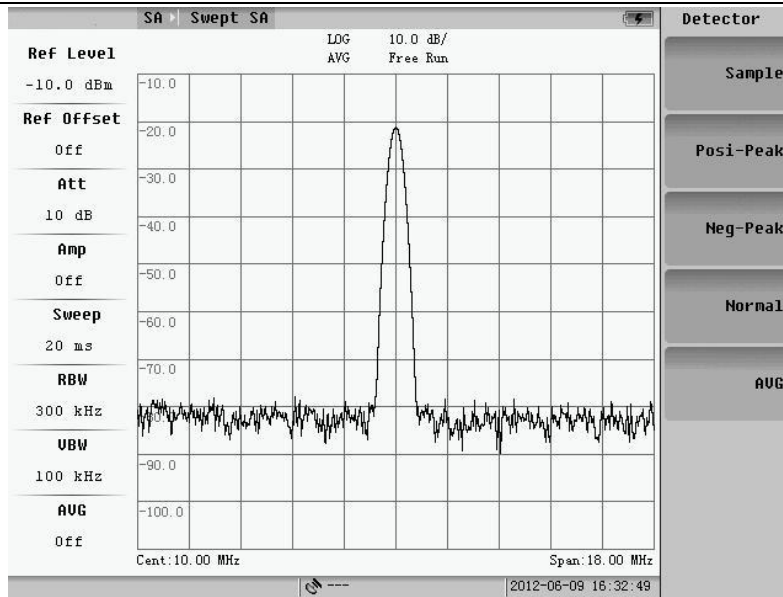

Fig.3.41 Average detector mode

5. Trigger Mode

Press Trigger soft-key, and then the submenu will appear. The default mode is free trigger one and instrument process nothing in free trigger mode.

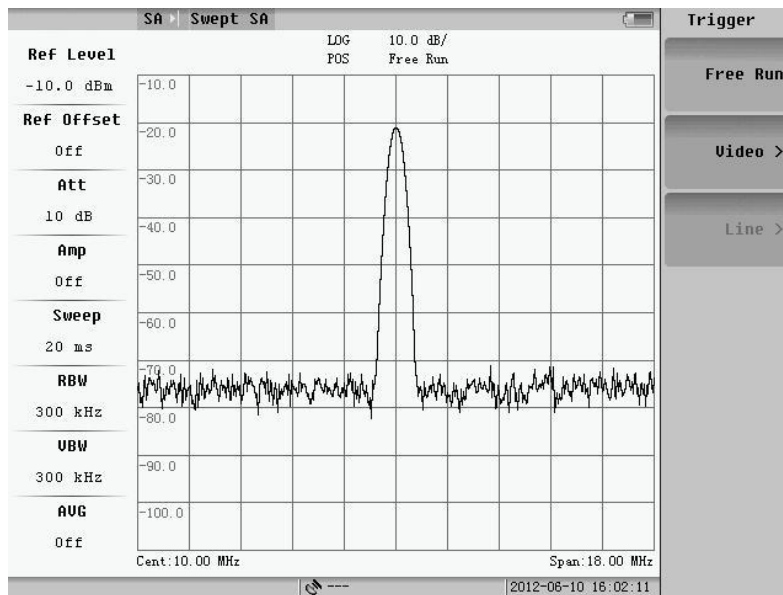

Fig.3.42 Trigger mode

3.2.3 Measurement parameters setting

User can press **MEAS SETUP** key to set some special function for measurement. Pressing key the follow menu will appear:

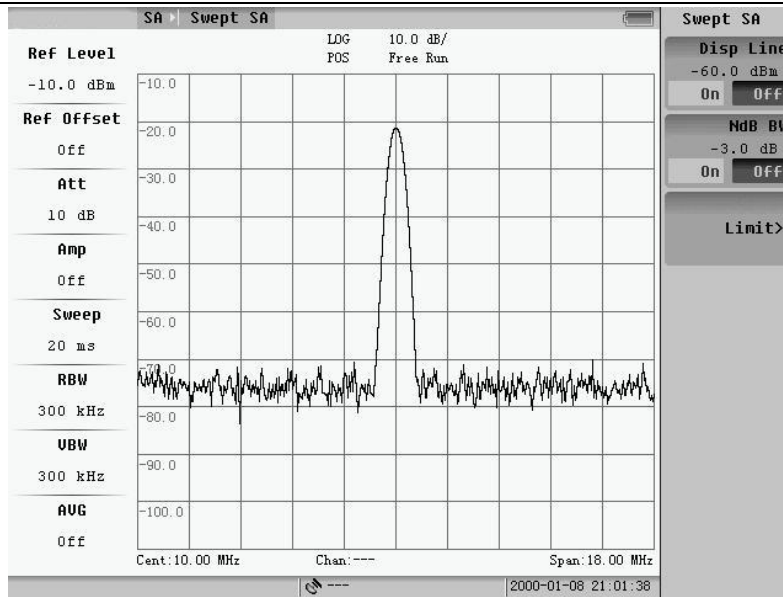

Fig.3.43 Measurement parameter setting

1. Display Line

Set “Disp Line” to “On”, a red line will appear in the mid of the screen and the amplitude of it will appear on the up-right of the screen.

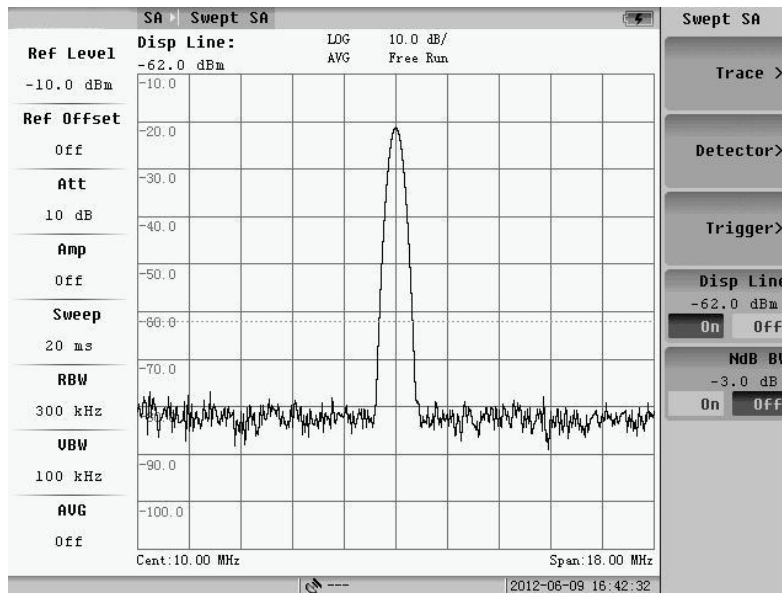

Fig.3.44 Display line ON

After setting “Disp Line” to “On”, the wave will be memorized and the amplitude difference of current wave and the memorized will be displayed around the “Disp Line”.

The default position of “Disp Line” is in the mid of the screen. User can change the position of it by rotating the knob or pressing the “Up/Down” Key.

2. NdB BW

Pressing key on the front panel, the submenu of it will appear which is shown as Fig.3.45.

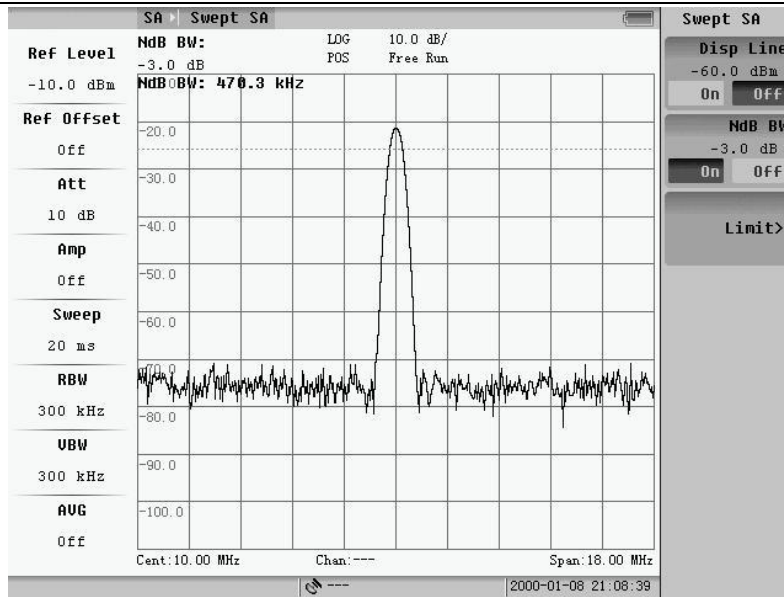

Fig.3.45 NdB setting menu

Pressing “NdB BW” soft-key and set the state of it to “On”. The system will display the information of N dB bandwidth that indicates the character of current used filter on the up-right of the screen. The default value is -3dB and the output is the frequency difference of two points which amplitude is 3dB lower than the peak value.

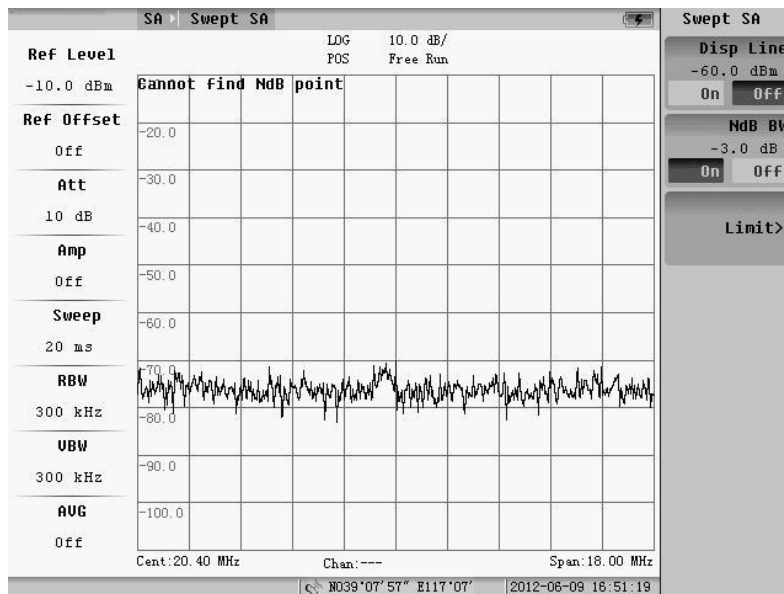

Fig.3.46 Can not find NdB point

3. Limit

The setup of limit is shown as following figure. The limit of Swept SA includes up limit and down limit.

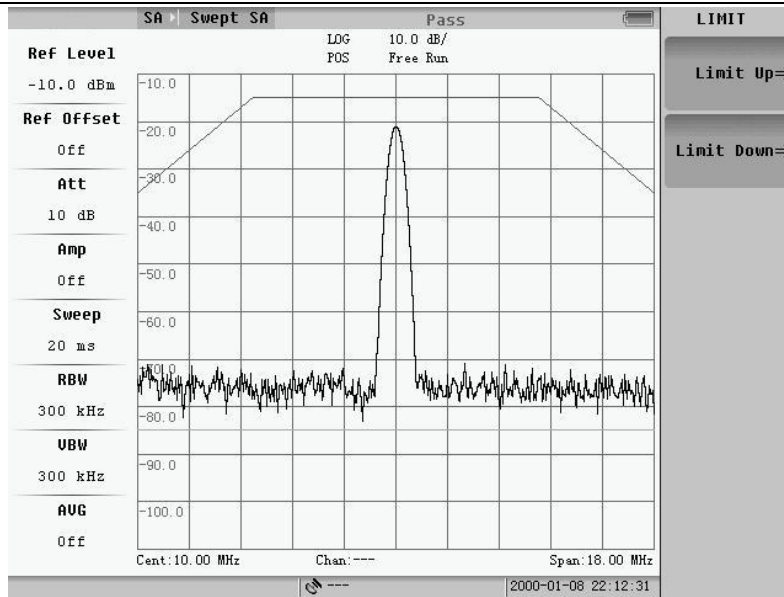

Fig.3.47 Limit setting menu

Pressing “Limit up” or “Limit down” soft-key and the limit setting dialog box will pop up as following figure showed.

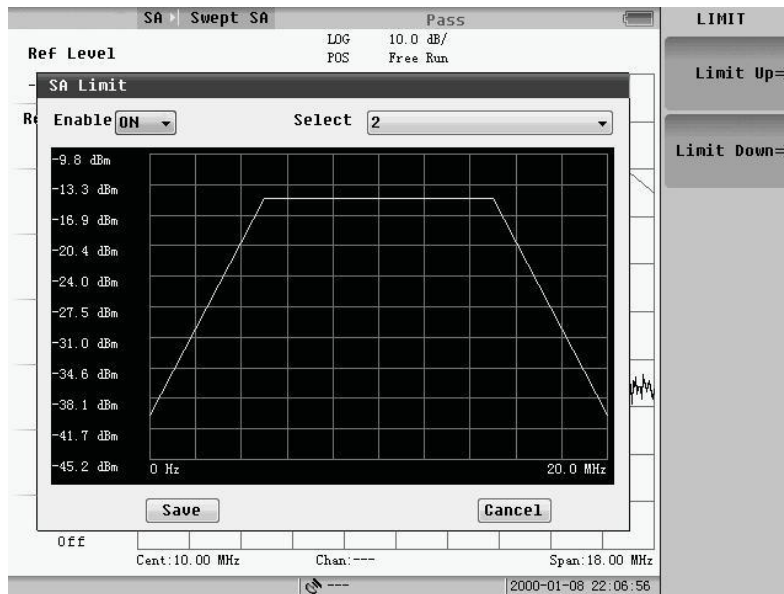

Fig.3.48 Limit setting dialog box

Rotating wheel or the up/down keys to move the focus to the dialog box, press the Enter key, and you can switch the limit between on and off. Moving the focus to the Limit number select and press the enter key, and we can select on limit line. The limit files can be edited by “Microsoft Office Excel”, which is post fixed by “.csv”. The files can be loaded in file manager. Detail will be told in the 4.2.4.

If the up limit is on, a green line showed as the dialog will be drawn. If the down limit is on, a red line showed as the dialog will be drawn.

If the up limit measuring is on and the level of every point is less than the up limit value, the measurement result passes, otherwise it fails. If the down limit measuring is on and the level of every point is greater than the down limit value, the measurement result passes, otherwise it fails.

The result of limit on the top of the screen is the final test result. As long as there is a failure of limit, the combined result was not qualified.

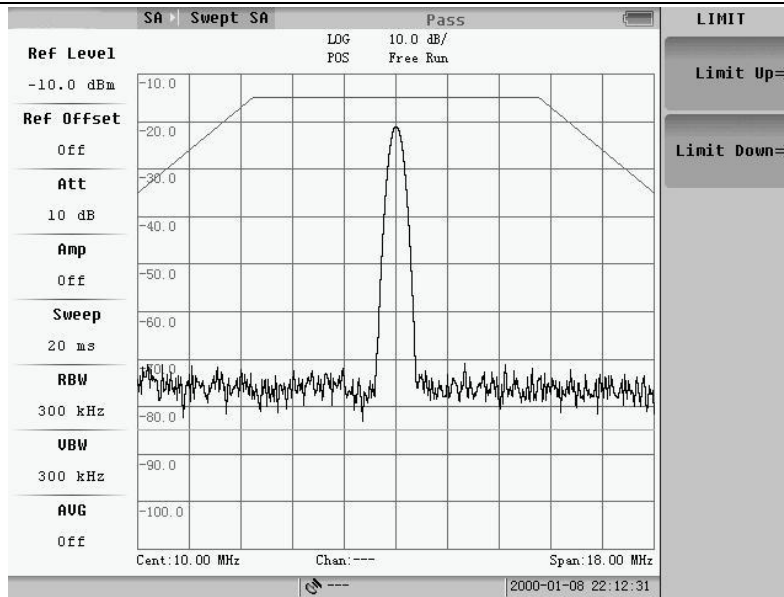

Fig.3.49 Limit measurement result

3.2.4 Basic usages

In this section, we will introduce the operations of marker, peak and etc.

1. Mark Operation

Pressing **MARK** key, the first page of menu will appear, and pressing the “Next page” sub-key the second page of menu will appear.

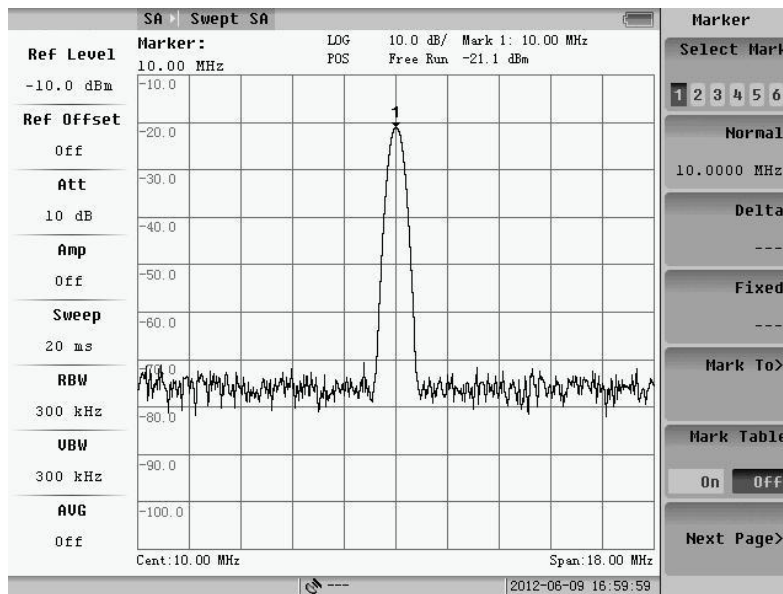

Fig.3.50 Mark menu (page 1)

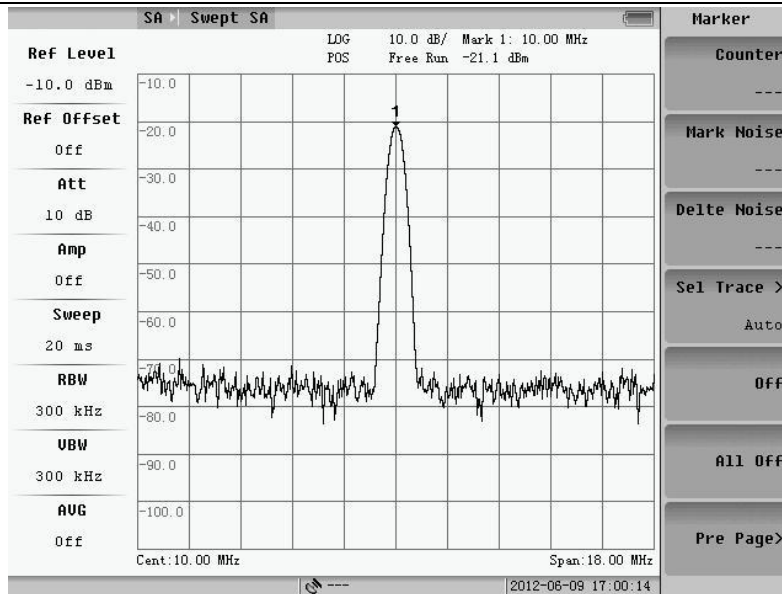

Fig.3.51 Mark menu (page 2)

If there is no marker on, the system will automatically set the normal marker to on. If there are some “On” markers, the state of these markers will remain unchanged.

1) Normal Marker

After pressing “Mkr Normal” soft-key or pressing NORMAL key while no marker is set “On”, the normal marker will appear on the screen. And at the same time the amplitude and frequency/time information of this marker will be displayed on the up-right of the screen. When the span is set to zero, the wave display on the screen is a time domain wave, so the abscissa is changed from frequency to time. The start time is zero and the stop time is equal to sweep time. The displayed marker information is changed to time too.

The abscissa of the marker can be changed by three methods:

- a. Press “Up/Down” cursor. The step change of this method is 1/10 of span.
- b. Rotate the knob. The step change is 1/500 of the span.
- c. Manually input the number user needed.

2) Delta Mark

After pressing this soft-key, two markers will appear on the screen. The start positions of these two markers are the same. Rotating the knob, pressing the “Up/Down” cursor or manually inputting the frequency value can change the position the second marker. The amplitude and frequency/time difference between two markers will be displayed on the up-right of the screen. The main function of “Delta Mark” is to compare two signals.

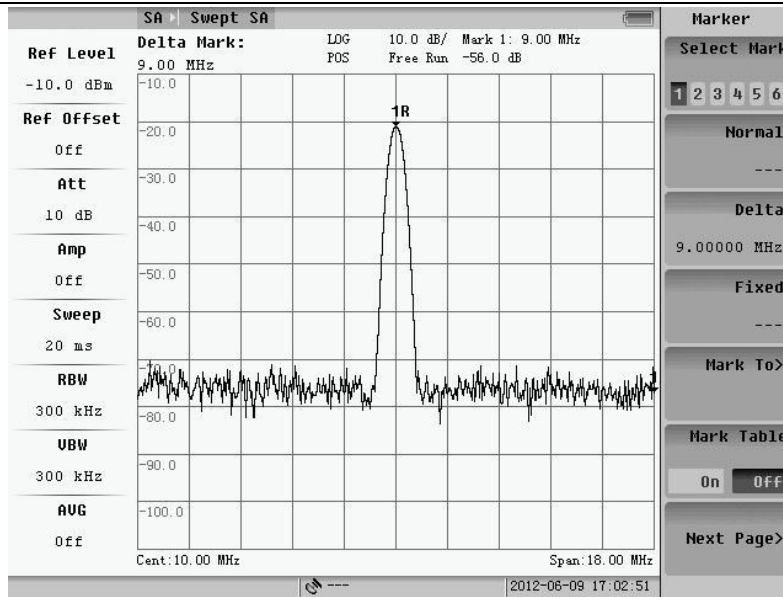

Fig.3.52 Delta mark

3) Fixed Mark

“Fixed Mark” is similar to “Delta Mark”: the main function is also to view the deference of two markers and the method to change the position of the second signal is the same. But the first marker will be frozen after setting the “Fixed Mark” to “On”, and its position will not change with the signal again only if the reference level or the frequency is changed (the absolute amplitude and frequency values of this marker are unchanged).

4) Marker To

In normal mark mode, pressing the key the follow submenu will appear. User can set current mark level as Ref level by soft-key of mark to Ref level, also can set current mark Freq as center Freq by key of mark to center Freq. At the same time the span BW is modified automatically.

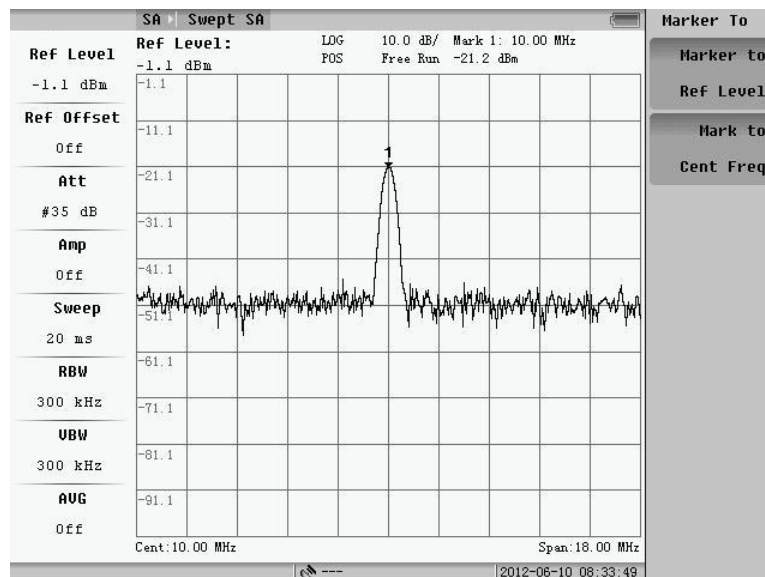

Fig.3.53 Before marker to Ref Level

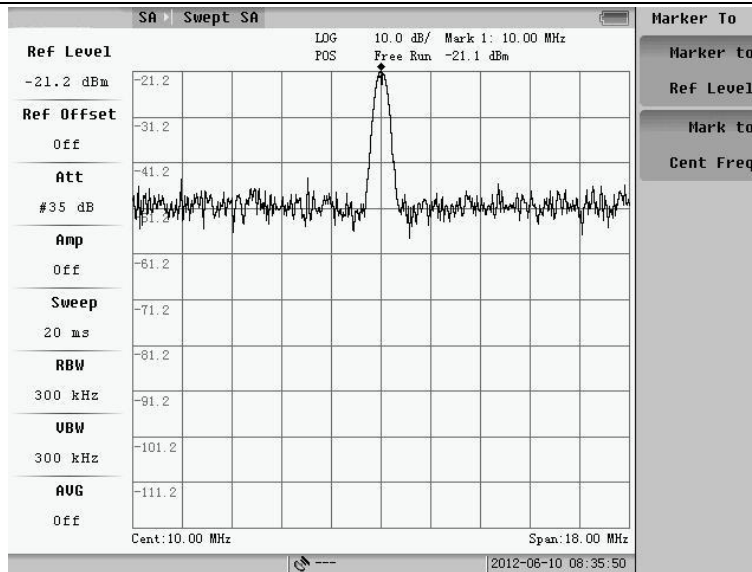

Fig.3.54 After marker to Ref Level

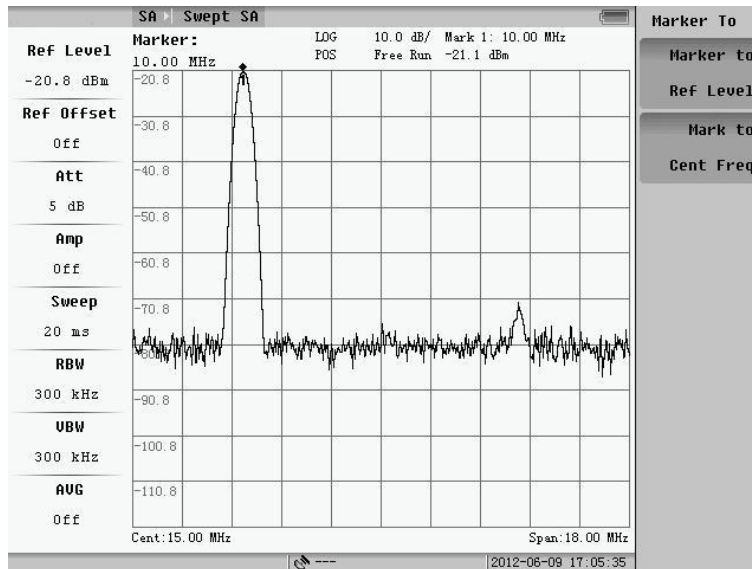

Fig.3.55 Before marker to Center Frequency

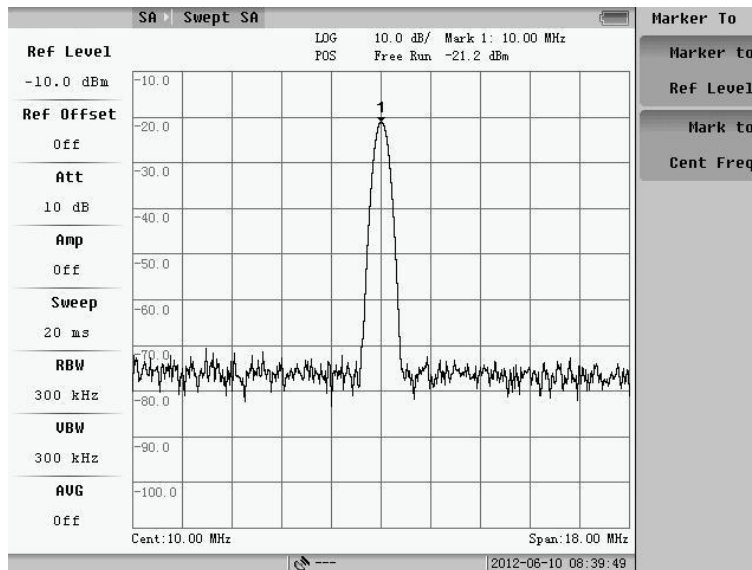

Fig.3.56 Before marker to Center Frequency

5) Multi-marker and Marker Table

The instrument can display 6 markers simultaneously. After pressing “Select Mkr” soft-key, User can switch between these markers and set the “On/Off” state of it.

After selecting the marker and set the state of it to “On”, user can change the marker’s position by the same way of changing “Normal Mkr”.

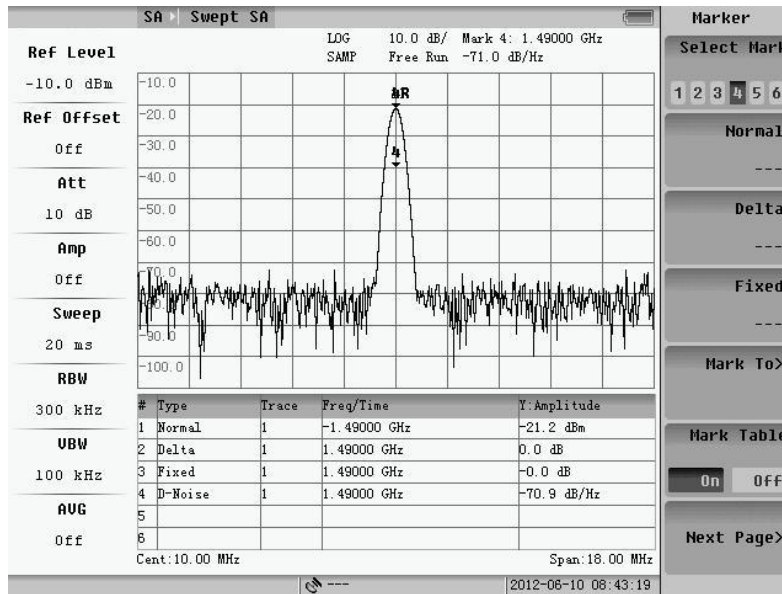

Fig.3.57 Marker table on

NOTE: When switch between “Mkr Normal”, “Delta Mark”, “Fixed Mark” and multi-markers, the pre-marker will automatically set to “Off”.

6) All off

Pressing "All Off" soft-key, all markers will be set to “Off”.

7) Count

Frequency count can give the accurate frequency of the strongest signal around the marker, which is working as a cymometer. The bandwidth of the counter is +/- 100kHz and the accuracy of it is Hz.

NOTE: If the “Count” soft-key is set to “On”, the displayed frequency will change from the frequency of marker to the frequency of the strongest signal around the marker.

8) Mark Noise

Set “Mark Noise” to “On”, and then user can get the average power of the noise. It will take the place of the amplitude to display on the up-right of the screen.

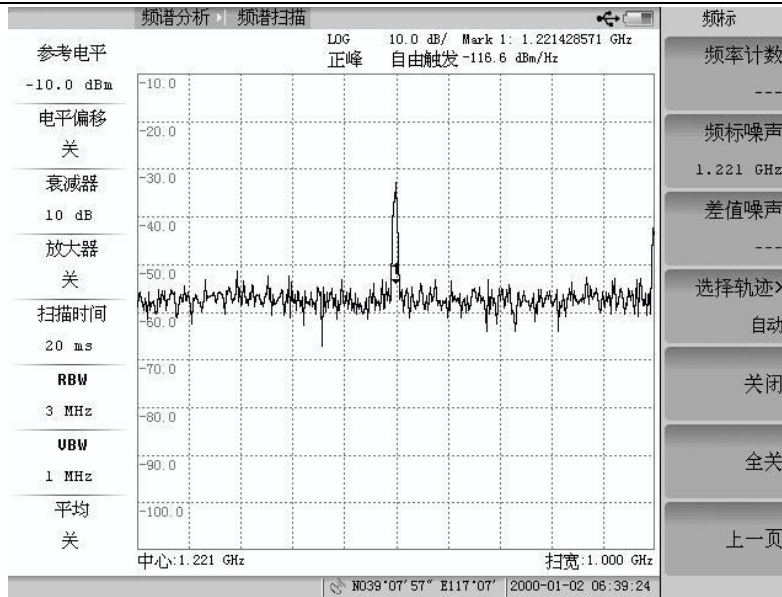

Fig.3.58 Marker noise on

9) Noise/Hz

Set “Noise/Hz” to “On”, the difference between current amplitude, and the average noise power will display on the screen.

10) Trace Selection

Pressing "Sel Trace" soft-key, submenu as Fig.3.59 will appear. There are three traces. One of them is not at the Blank state as it is at activate. Selected trace will choose the marker working trace during these traces which are activate. The default value is auto, which will choose the first activate traces.

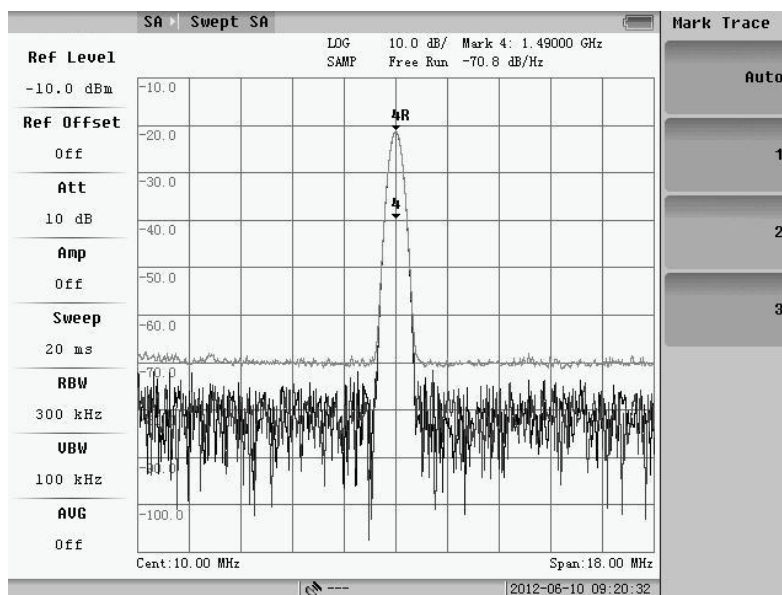

Fig.3.59 Trace selection

2. Peak Operation

Pressing **PEAK** key, the first page of peak menu will appear, and the second page will appear if “NEXT page” button is pressed.

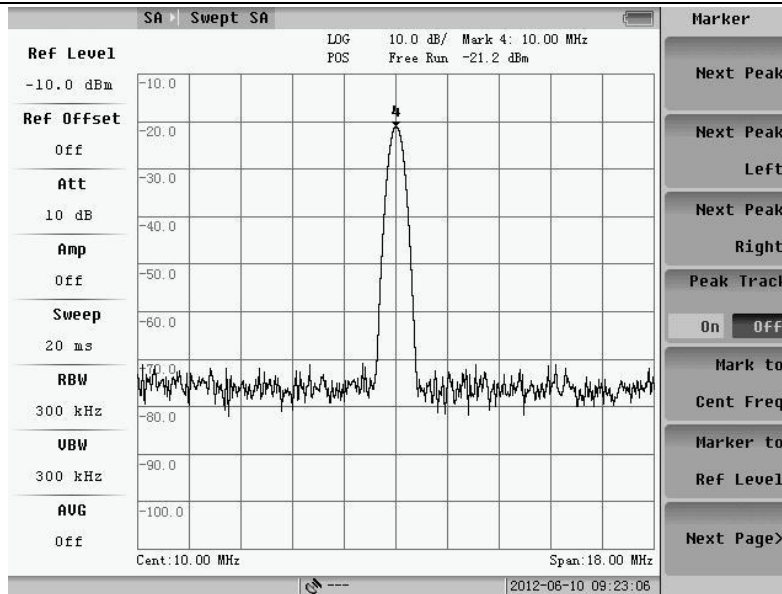

Fig.3.60 Peak menu (page 1)

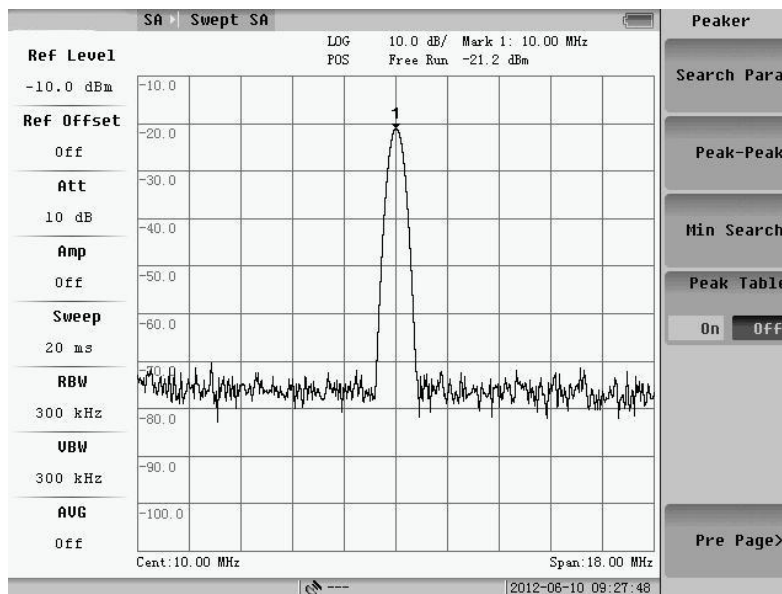

Fig.3.61 Peak menu (page 2)

If there is no marker setting to “On”, the system will search the peak signal in the span and set marker on it when user press the PEAK key.

1) Next Peak, Next Right Peak and Next Left Peak

Next Peak: Search for the hypo-peak value that is lower than the marked one.

Next Right Peak: Search for the hypo-peak value on the right side of current marker.

Next Left Peak: Search for the hypo-peak value on the left side of current marker.

2) Peak Track

Set the state of “Peak Track” to “On”, and the system will search the “Peak” with the change of the wave automatically. Otherwise the peak marker will stay on the firstly searched frequency/time.

3) Marker to Center and Marker to Ref Lvl

When there is only one marker is “On”, press “Marker To Center”/“Marker To Ref Lvl” can set the

frequency/amplitude of current marker to center frequency/reference level.

4) Search Conditions

Press the "Search Para" key, and then the below menu will pop up. The search criteria are used to set the search for peak conditions. The default of system is automatic mode. In auto mode, the "absolute level", "relative level" and "relative points" cannot be changed. When set to manual mode, you can set up by entering values, up and down keys and the roller, thus search the peak of conditions.

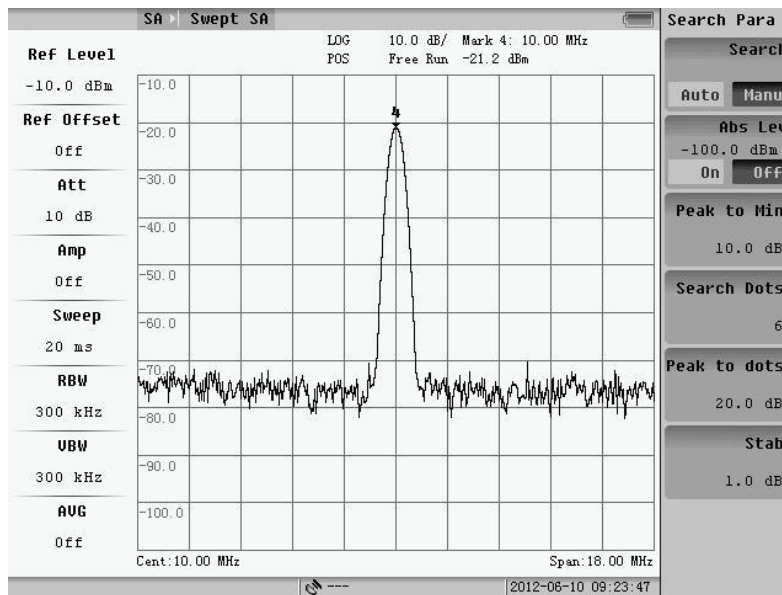

Fig.3.62 Search parameters

5) Peak-peak and Min Search

Press the "peak to peak" key on the top of the screen, and the amplitude of the highest frequency will be marked within the span;

Press the "minimum" on the top of the screen, and the amplitude of the lowest frequency within the span will be marked.

6) Peak Table

Peak table has the similar format as marker table. It can sort the found peaks by "Freq" or "Amp" pressing the "PK Sort" soft-key. When setting the "PK Table" to "On", the system will search 6 peaks and sort them with frequency or amplitude. The default state is by amplitude. The frequency/time and amplitude information of these peaks will display on the bottom of the screen. The peaks will change as the wave change.

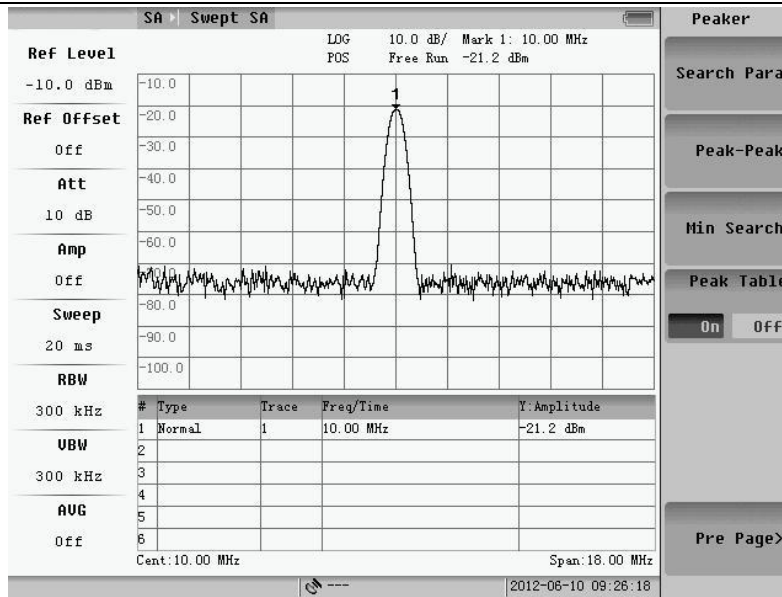

Fig.3.63 Peak table

3.3 Channel Power

Channel Power refers to the whole power of the signal in certain span. Set the type of measurement for channel power, and the following menu will pop up.

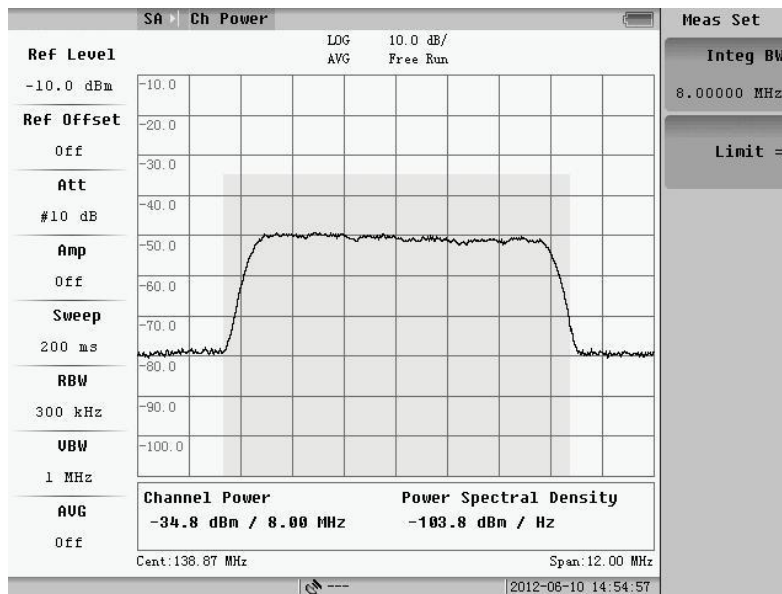

Fig.3.64 Channel bandwidth measurement

The area between the two lines is the Channel Bandwidth; the height is the whole power of channel. In the little window at bottom, the power represent the overall power of the channel under test, the spectral density of Channel power stands the power of per Hz within the channel bandwidth.

3.3.1 Basic measurement

1. Frequency

Pressing **Freq** key, the following menu will pop up. User can set up center frequency and step frequency for span

power measurement. The method of setup is same as the setup of Swept SA.

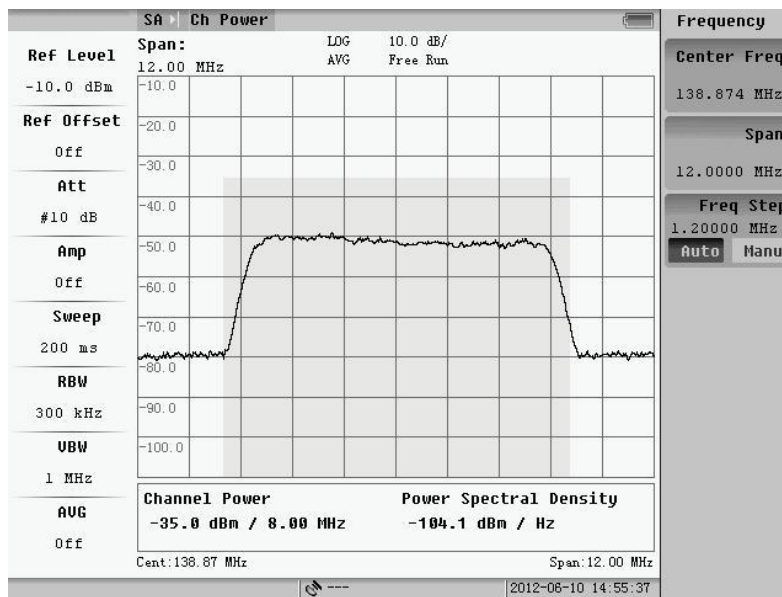

Fig.3.65 Frequency setting

2. Amplitude

Pressing **AMPTD** key, the following menu will appear.

The default set of system is Auto level status. If the signal has relatively large fluctuations, the system will automatically adjust the attenuator and amplifier, in order to make sure that the input power is ether too overload or low. If the automatic level is OFF, user can modify the magnitude parameters manually, such as reference level.

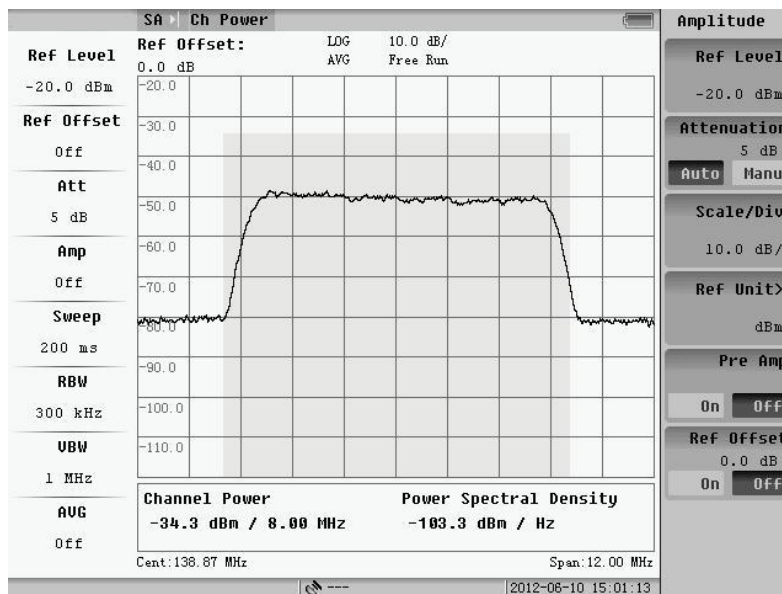

Fig.3.66 Amplitude setting

1) Reference Level

The function of Ref Level is same in a certain type of frequency scan. Changing the Ref Level only changes the display position of wave, not the measurement of span power. The method the modify Ref Level is same as spectrum scan. The follow 2 chats show the influence to wave when changing the Ref Level in same measurement conditions.

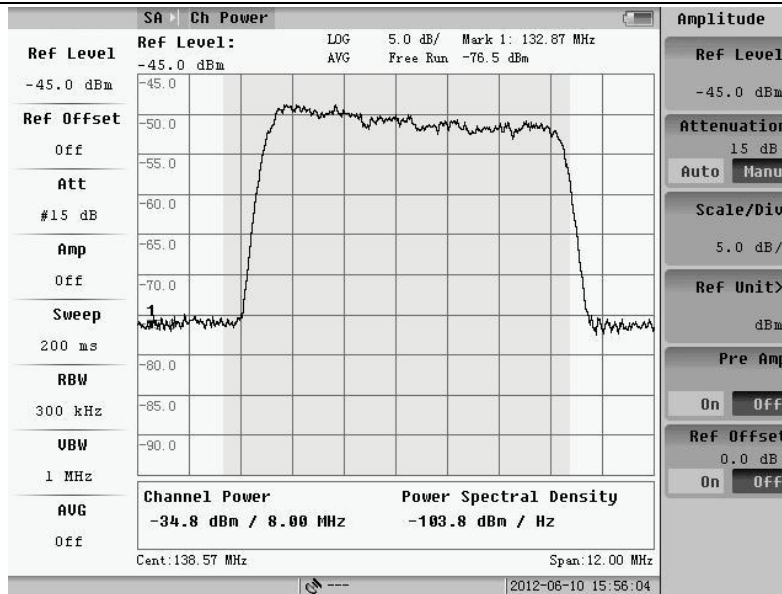

Fig.3.67 Reference level is -45dB

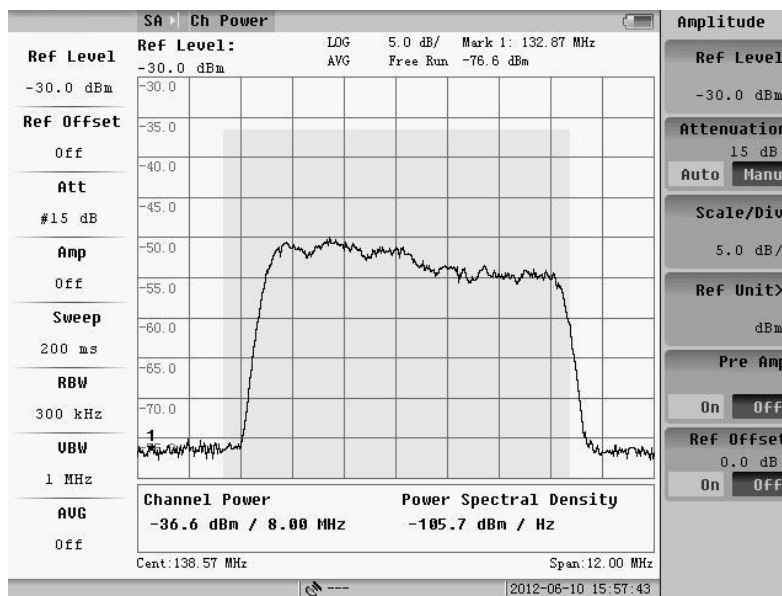

Fig.3.68 Reference level is -30dB

2) Attenuator and Amplifier

Attenuator is an important part of the Instrument. It can reduce the signal distortion by attenuating the power level of the mixer input signal. The value of attenuator is from 0 to 55dB with 5dB step, the default value is 10dB. In auto mode, the system can automatically provide a suitable value of attenuator. If user wants to set the attenuator manually, user should firstly set the “Atten” soft key to “Manu”, and then input the value by number keys, “Up/Down” key or the knob. By “Up/Down” cursor or the knob, the change step is 5dB. When inputting value by number keys, the step is 1dB.

Fig.3.69 and 3.70 show the measurement results under different attenuator. From the channel power measurement parameters and the blue background height of channel power, we can see the influence of attenuator on the waveform: at the same time we can also observe the impact of the attenuator the noise floor.

Inside the instrument there is a switch for preamplifier, when the signal amplitude is small and cannot meet the

measurement requirements, you can switch on this amplifier to increase the system test range.

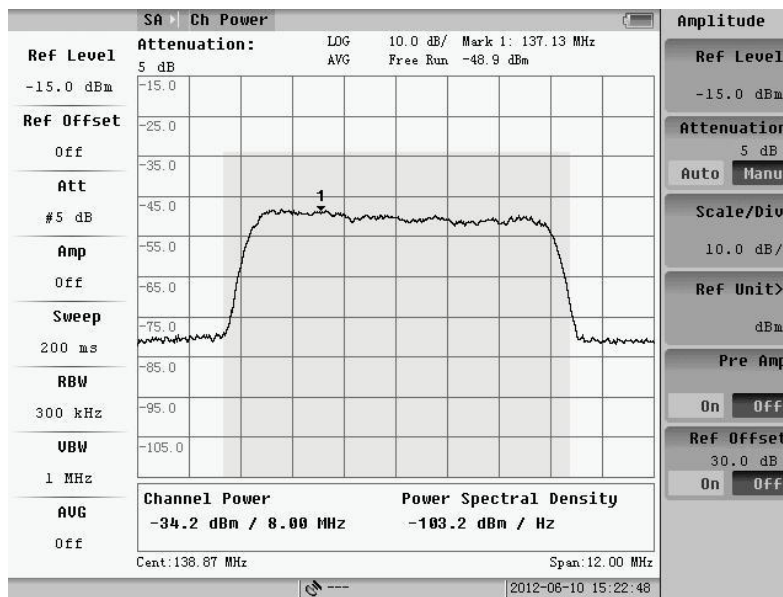

Fig.3.69 Attenuator is 5dB

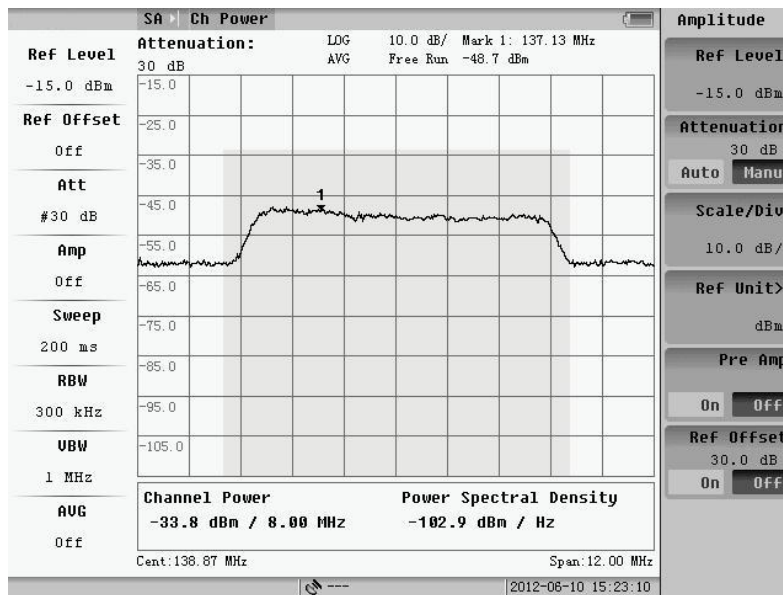

Fig.3.70 Attenuator is 30dB

Fig.3.71 and 3.72 show the measurement results between the amplifier close and open. From the channel power measurement parameters and the blue background height of channel power, we can see the impact of amplifier on the waveform.

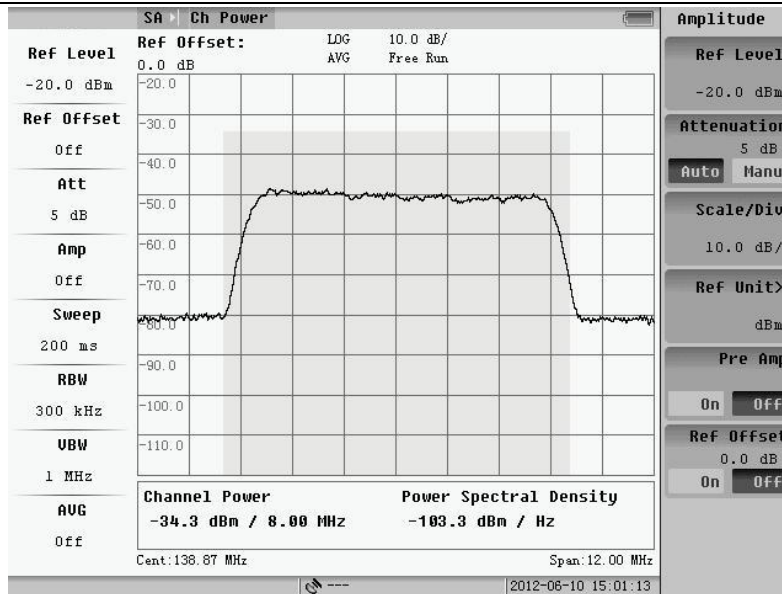

Fig.3.71 Amplifier is off

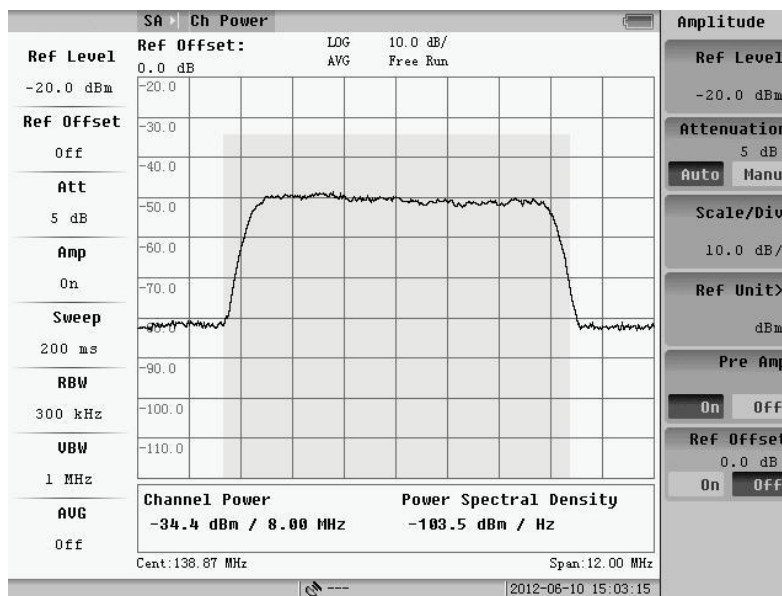

Fig.3.72 Amplifier is on

3) Scale/Div

The valid value of Scale/Div is 1-40. The default value is 10dB/grid. After pressing “Scale/Div” soft-key user can enter the integer number from 1 to 40 or decimal number from 0.1 to 0.9 to change the scale to the state wanted. Decreasing the value, the waveform will be amplified, and it is easy to observe the waveform details. The following figure shows the result of 5dB/Div.

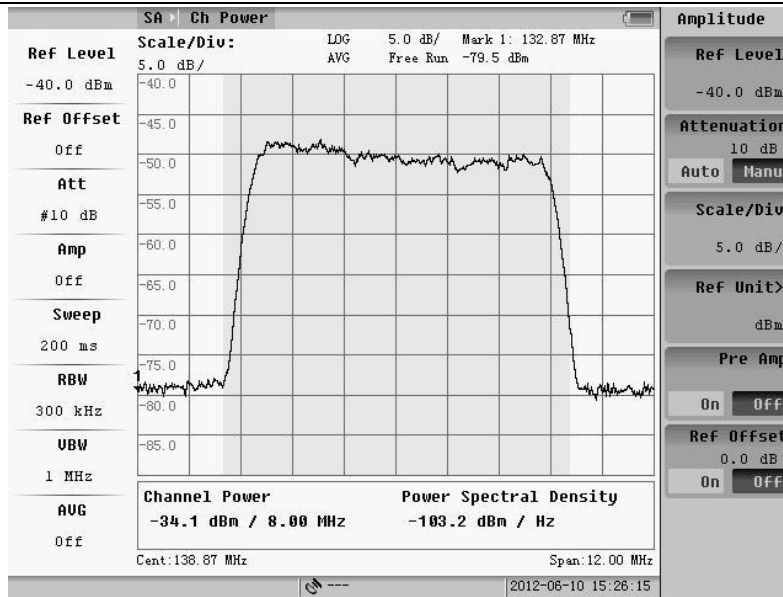

Fig.3.73 5dB/Div

4) Ref Offset

If level offset is opened, the amplitude of waveform will be magnified and the channel power will also be changed according to the waveform. The following figure shows the measurement results under different conditions of the level offset.

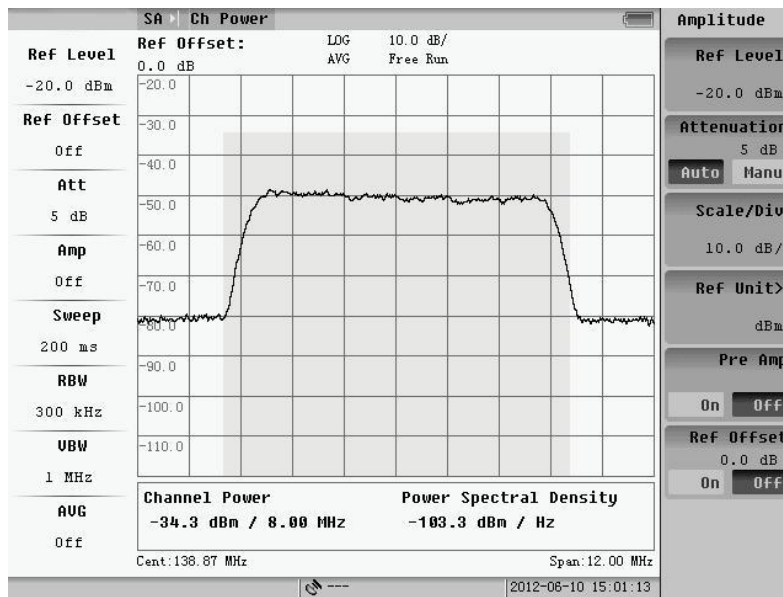

Fig.3.74 Level offset is off

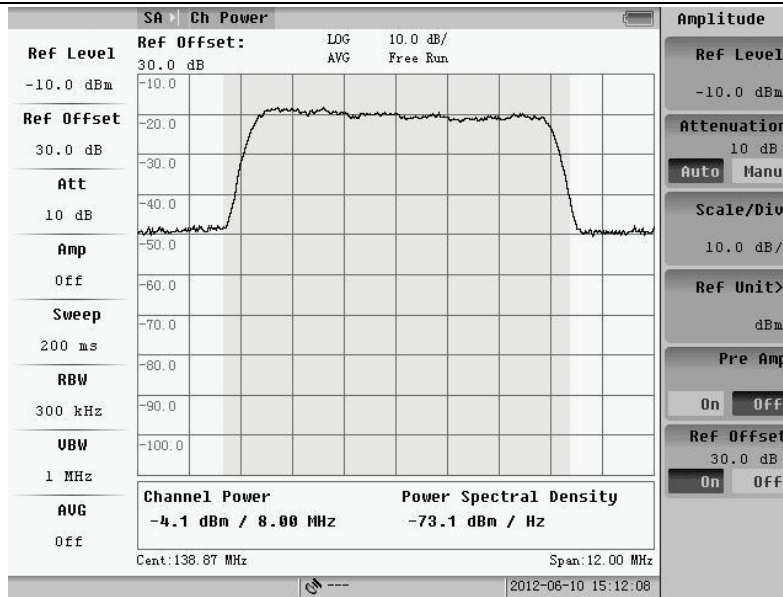

Fig.3.75 Level offset is 30dB

3.3.2 Basic parameter setup

The basic parameter setup is only about the video average and scan type. Other parameters such as resolution BW, video BW and scan time are configured by system default.

By pressing the **CPL** key, change the basic parameter, and the following menu of figure will appear:

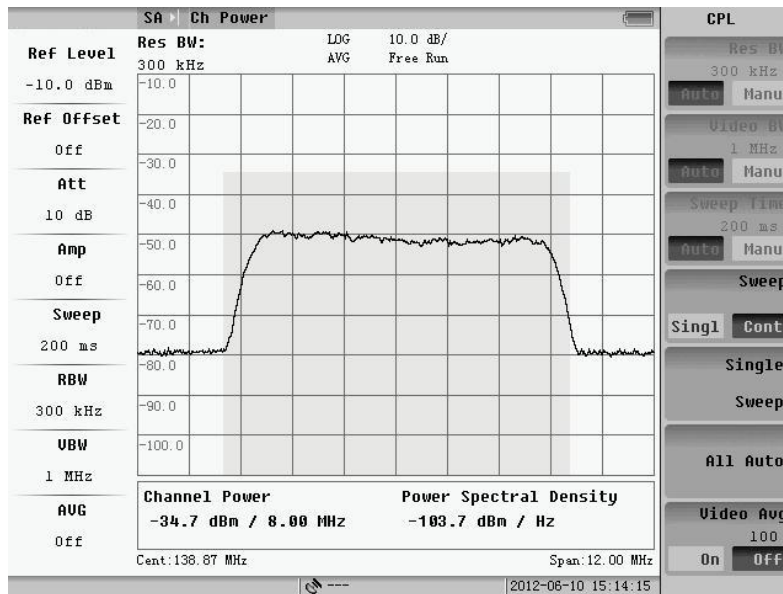

Fig.3.76 Basic parameter setting

The basic parameter setup and theory of span power is same as frequency scanning method.

3.3.3 Measurement parameter setup

Pressing **MEAS SETUP** key, set some special function when measuring.

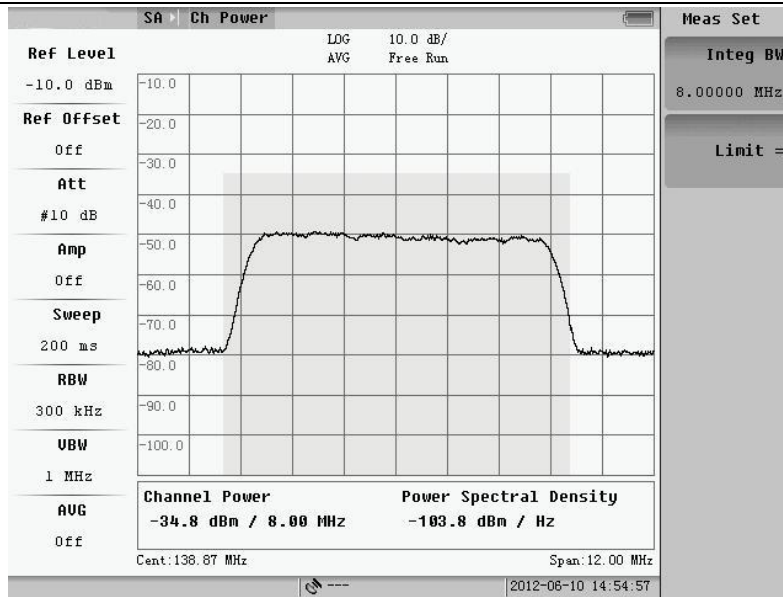

Fig.3.77 Measurement parameter setting

1. Channel BW

After select center frequency, user can set the channel BW by inputting the frequency manually. The default channel BW is 8MHz. In order to measure accurately, the span frequency is set to 1.5 times the channel BW.

Channel bandwidth is proportional to span. Therefore, span will be changed according to channel BW value. The channel bandwidth can also be changed by digital inputs, up and down key and knob.

2. Limit

The main contents of Channel power includes channel power and power density, so there is the limit of channel power and power density.

Limit is set as shown below. Pressing the soft key of the limit, the following dialog box will pop up as shown.

Master switch controls all limit measurement. When turning off, all settings are not editable, showing as below:

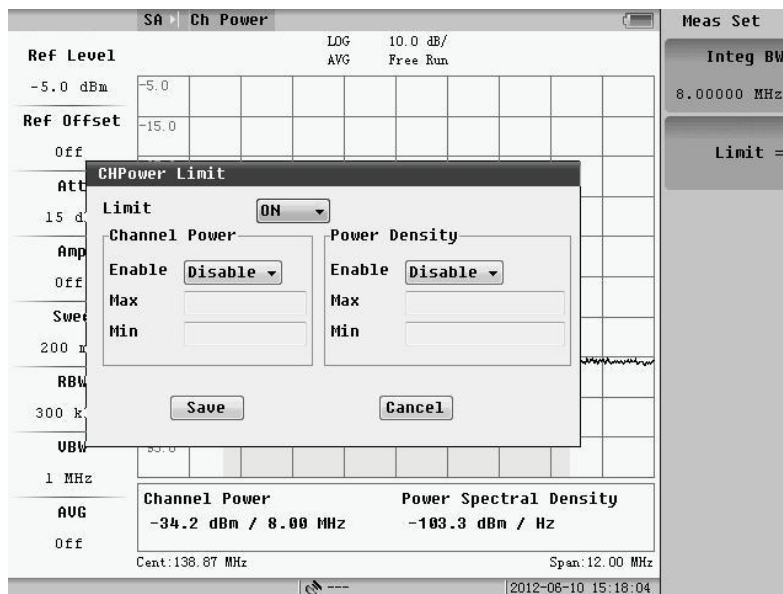

Fig.3.78 Limit is on

Only when the master switch and a measurement limit switches are turned on, the limit measurements can be

measured and set.

The limit settings dialog box is shown below after turn on the limit.

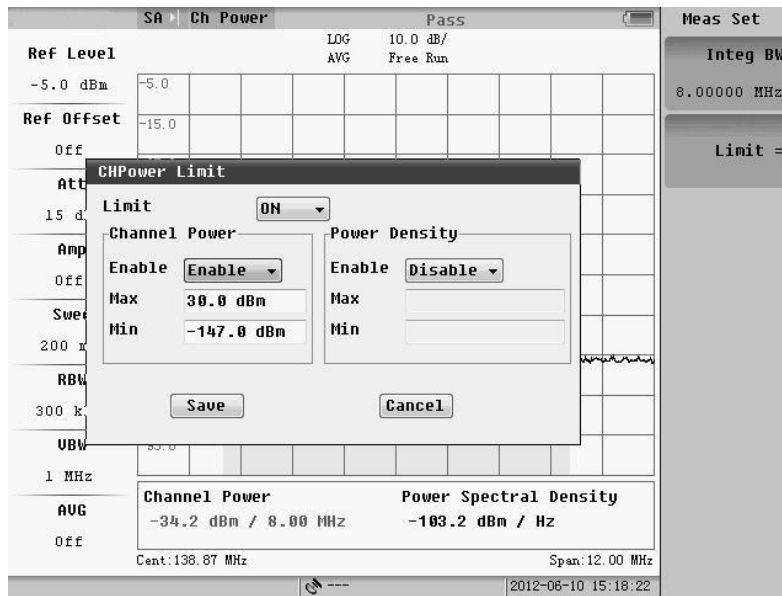

Fig.3.79 Limit value setting

The limit setting dialog box is shown below after turn on the limit.

There are upper and lower limit settings for limit of Channel power and power bandwidth, rotating wheel or the up/down keys to move the focus to the dialog box. Pressing the Enter key, we can edited and input number by number key, the default unit is amplitude, then confirm input by soft-key or enter key.

If the limit measuring is enable and the value is between the upper and lower limits, it is qualified and marked by green character, otherwise unqualified marked by red characters. If the limit is not enabled, the result is still displayed in white characters. The result of limit on the top of the screen is the final test result. As long as there is a failure of limit, the combined result was not qualified.

3.3.4 Basic usage

Basic usage refers to marker and peak functions.

1. Marker Function

Pressing **MARK** key, the following menu will pop up. It is about normal marker and delta marker. The theory is same as Swept SA.

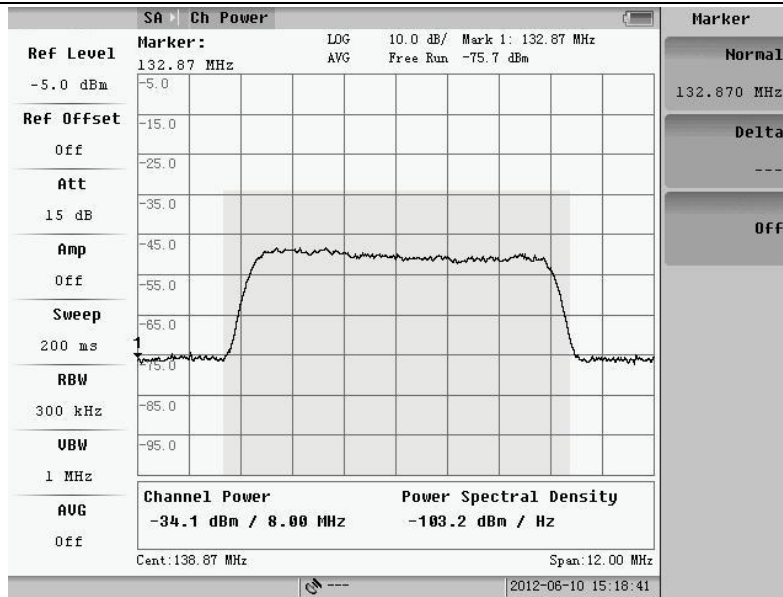

Fig.3.80 Mark menu

2. Peak Function

Pressing **PEAK** key, the following menu will pop up. Peak function includes next peak, next left peak, next right peak, search condition, peak-peak and minimum value.

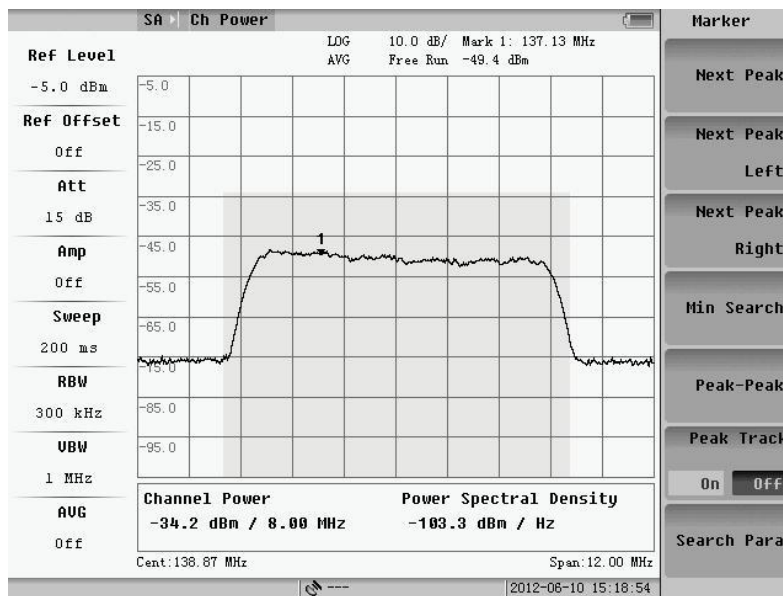

Fig.3.81 Peak menu

3.3.5 Burst RF basic parameters setup

The operation of frequency and amplitude of Burst RF and continuous RF measurement is the same.

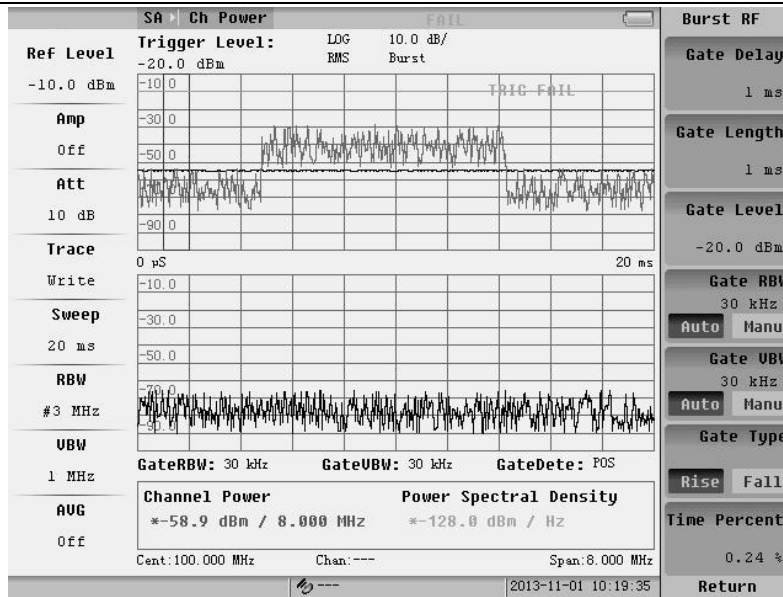

Fig.3.82 Burst RF interface

Pressing **CPL** key, the menu of parameters setting of Burst RF will pop up. The Sweep Mode and Trigger should be noticed. Sweep mode only includes "no FFT" mode, and the default of Trigger is trust RF. If you choose the free triggered, it would lead to Burst RF into the Continuous RF.

3.3.6 Burst RF measurement setup

The difference between Burst RF and continuous RF measurement is the Burst RF settings.

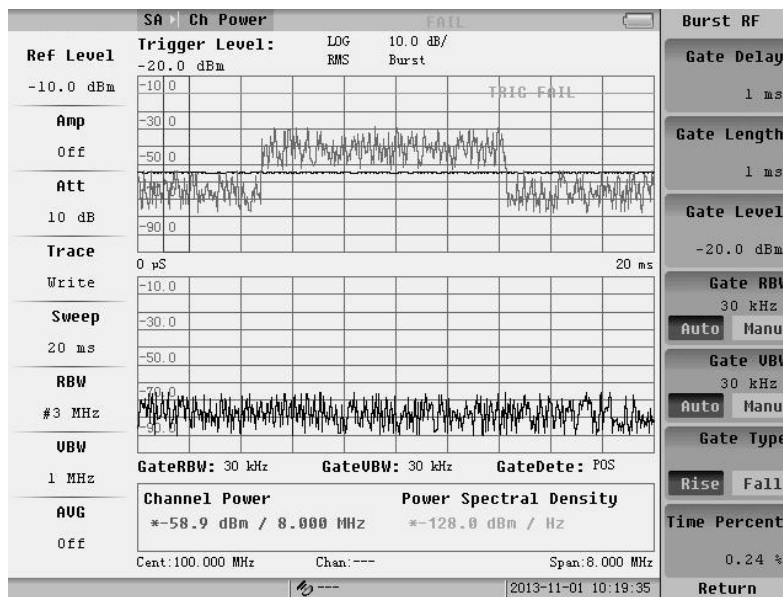

Fig.3.83 Burst RF setting

1. Gate Delay

According to a period of time domain graph into frequency waveform.

2. Gate Length

This set the width of the time domain waveform.

3. Gate Level

According to adjust the size of the trigger level, When the red line can come into contact with the gray waveform,

triggers succeeds. If not, trigger fails.

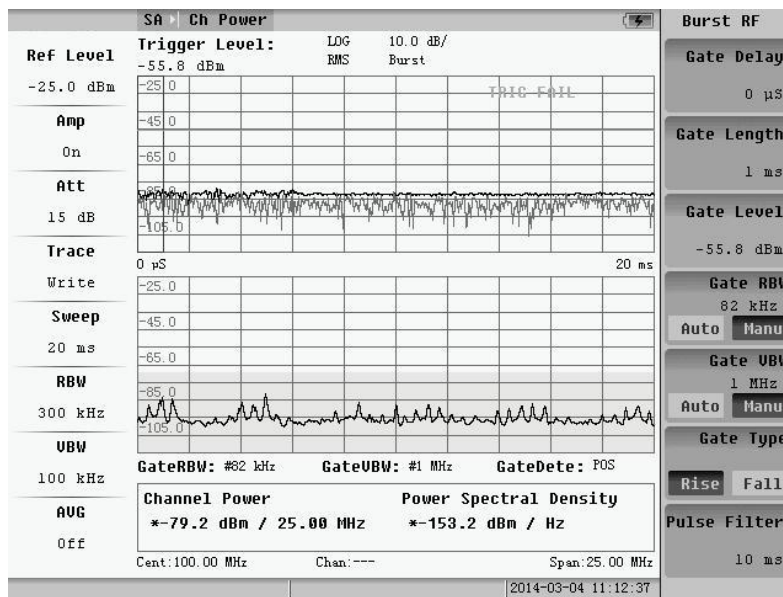

Fig.3.84 Trigger fails

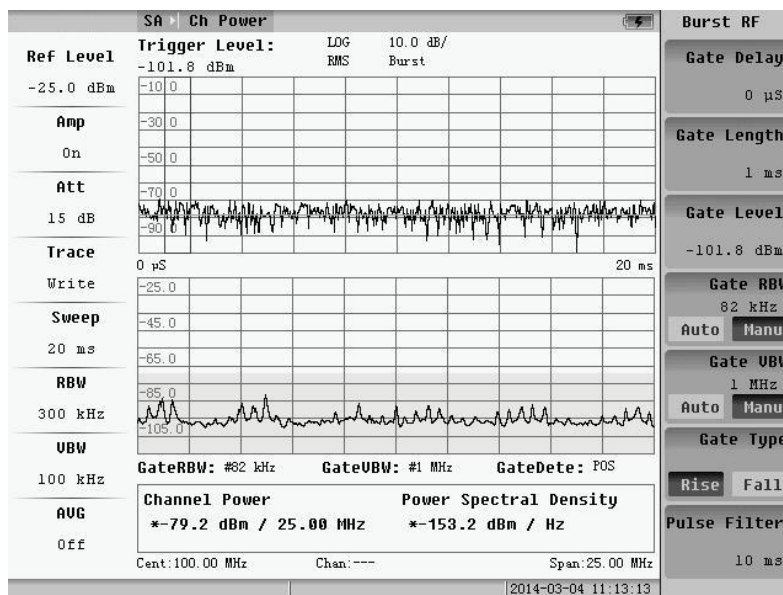

Fig.3.85 Trigger succeeds

4. Gate RBW

This set time slot wave spectrum resolution bandwidth.

5. Gate VBW

This set time slot wave spectrum resolution bandwidth.

6. Gate Type

Trigger mode is divided into the rising and falling trigger.

3.4 Adjacent Channel Power

The bandwidth of adjacent channel is the same as the bandwidth of the current tested channel. In Channel Measurement Menu, when user presses soft-key “Adjacent Channel Power”, the Adjacent Channel Power Menu

will appear that looks like below:

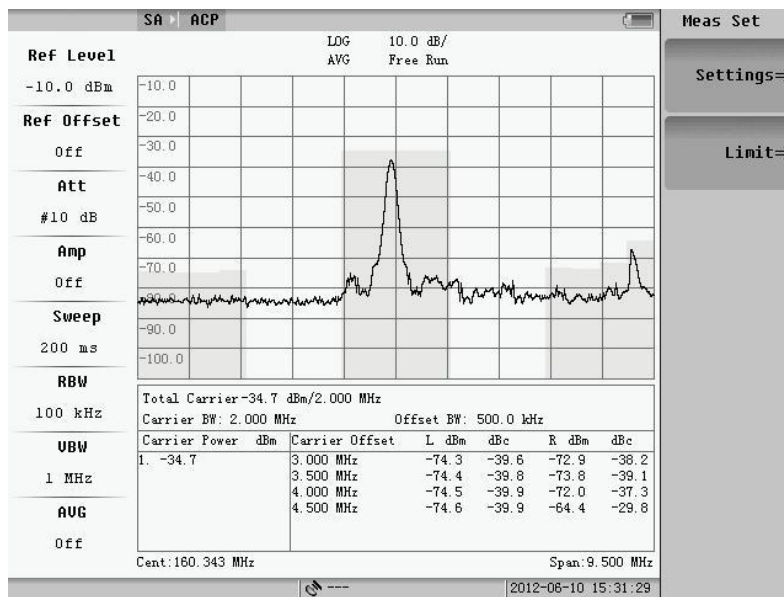

Fig.3.86 Adjacent channel power

3.4.1 Basic measurement

1. Frequency

Pressing **FREQ** key, the menu of Adjacent Channel Power will pop up, user can measure center frequency and step frequency.

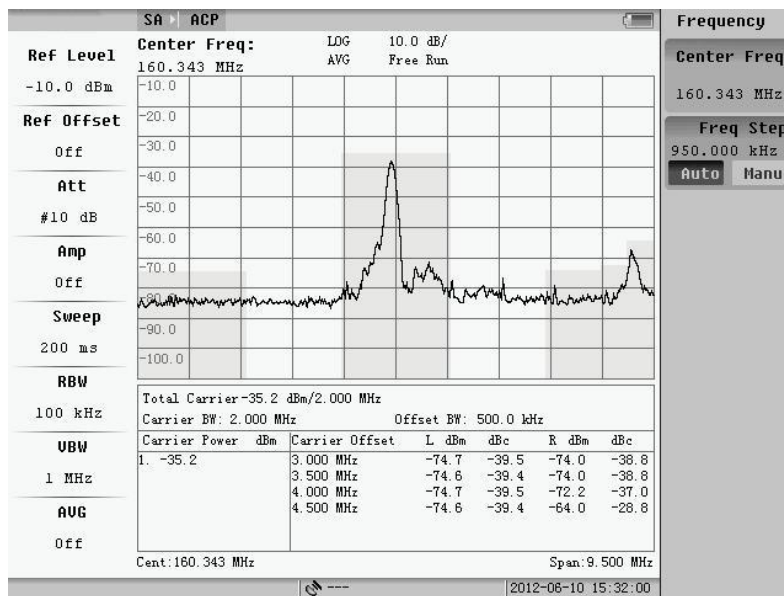

Fig.3.87 Frequency menu

2. Amplitude

Pressing **AMPTD** key, the follow menu will pop up. The default is “Auto Level” open state. When the input signal fluctuates largely during measuring, the system will automatically adjust the attenuator and amplifier. Furthermore, the average power can also be used to smooth the results. If Auto level is off, user can change the parameters manually.

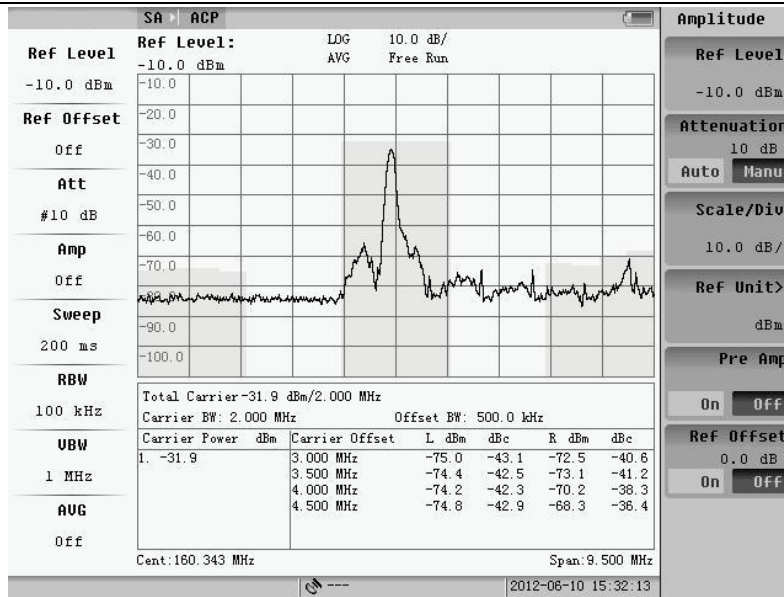

Fig.3.88 Amplitude menu

3.4.2 Basic parameter setup

The parameter config of Adjacent Channel Power is same as channel power. It is only about the video average and scan type; other parameters are set by system default.

Pressing **CPL** key, user can set the basic parameters.

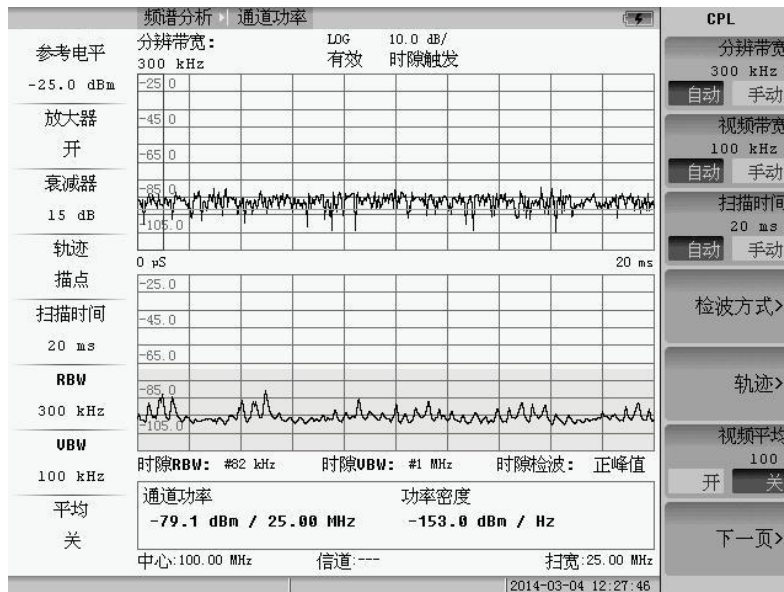

Fig.3.89 Basic parameter setting (page 1)

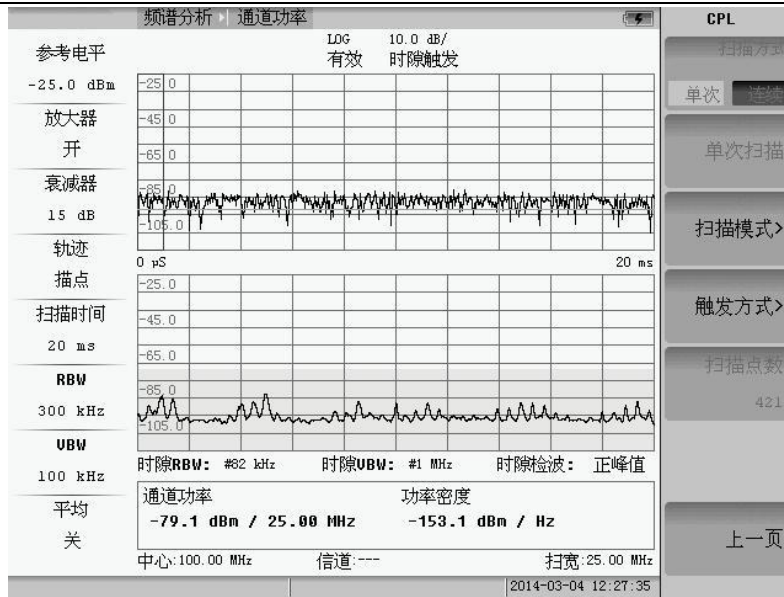

Fig.3.90 Basic parameter setting (page 2)

3.4.3 Measurement parameter setup

User can set some parameters for Adjacent Channel Power by pressing **MEAS SETUP** key.

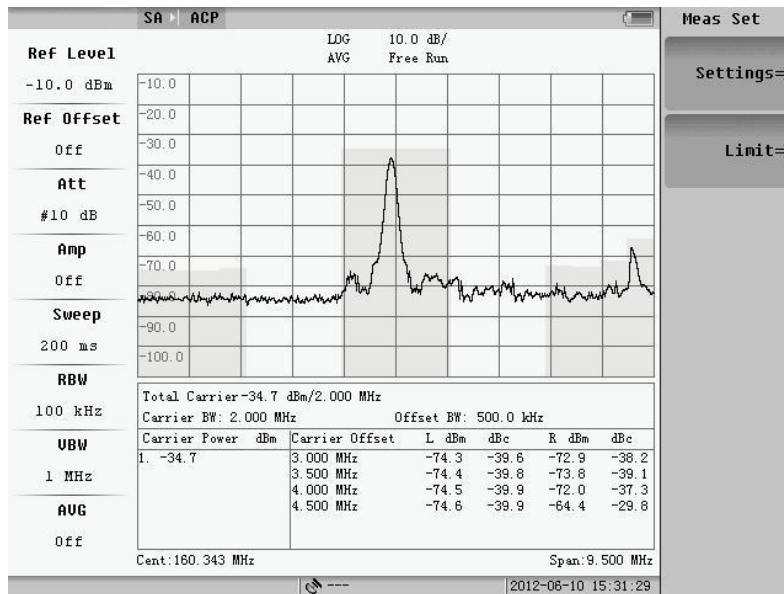

Fig.3.91 Measurement parameter setting

1. Parameter Setup

Pressing soft-key, the dialog box will pop up. Set current focus for setup by knob the drop-down menu or manually input, set the required parameters, and then press "OK" button to save the settings and exit the dialog, "Cancel" button to cancel the settings and exit the dialog box.

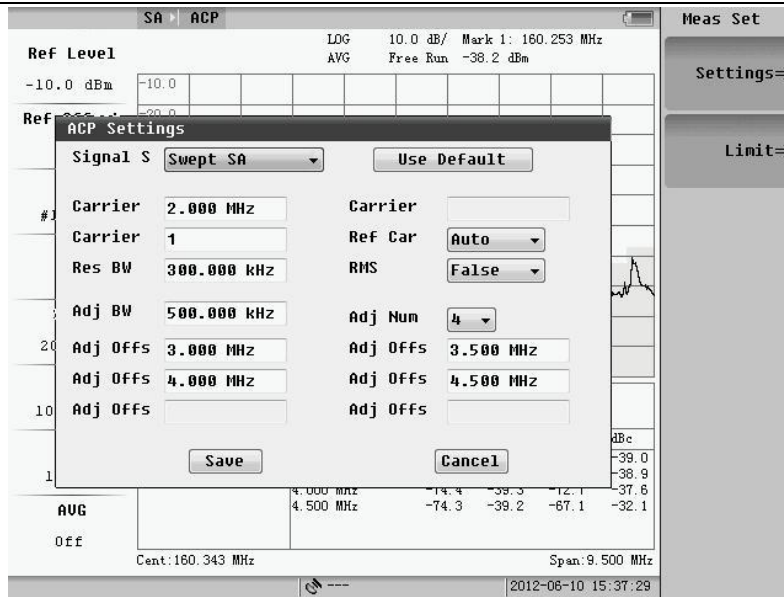

Fig.3.92 Parameter setup

User can select the "Restore Default" item to set the parameters to default value. The default value is satisfying with most measurement.

2. Limit

The setup of limit is shown as follow figure.

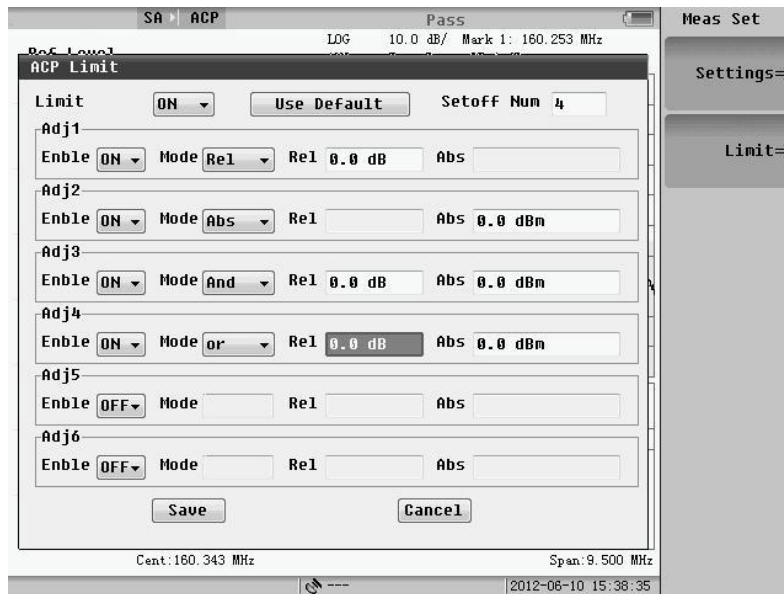

Fig.3.93 Limit value setting

The function is controlled by a the master switch and respective switch.

The limit of adjacent channel power includes absolute and relatively limits. Absolutely limit is for adjacent channel power; relatively limit is about adjacent channel power relative to the carrier. When the adjacent channel power is less than the absolute limit, it is qualified; when the relative value is less than the value of the relative limit, it is relatively qualified. Qualified, unqualified and did not enable are marked by green, red and white.

Each pair of adjacent-channel limit has four models, absolute, relative, and or.

Please refer to the setup of Fig.3.93. The result is shown as Fig.3.94.

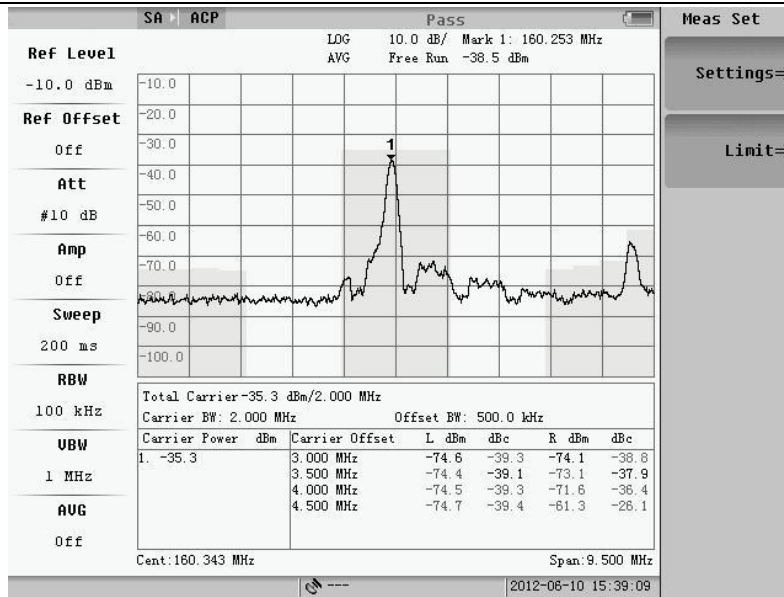

Fig.3.94 Limit measurement result

3.4.4 Basic usage

1. Marker Function

The figure will pop up after pressing **MARK** key. It is about normal mark and delta mark.



Fig.3.95 Mark menu

2. Peak Function

Press **PEAK** key, the menu of peak will pop up as following figure.

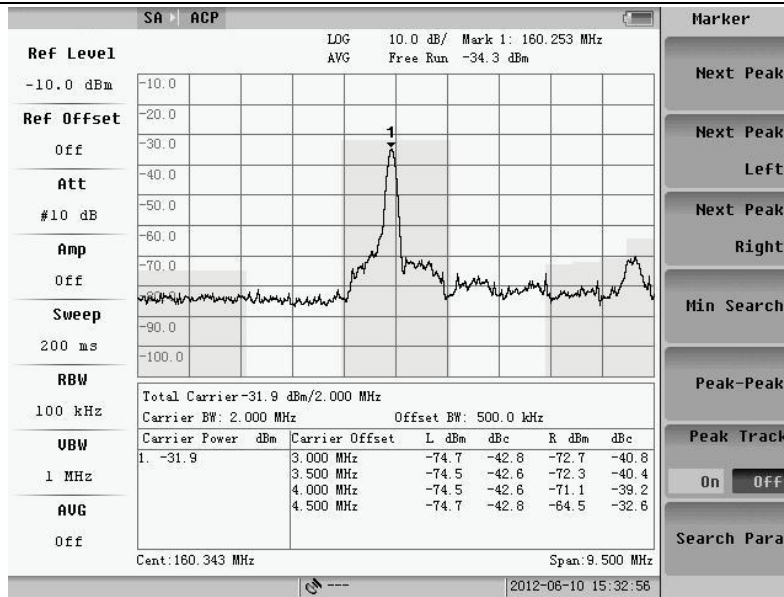

Fig.3.96 Peak menu

Peak function includes next peak, next left peak, next right peak, search condition, peak-peak and minimum value.

3.5 Occupied BW

Occupied Bandwidth is the frequency range, which represents certain percent of the whole power. In Channel Measurement Menu, user can press soft-key “Setting” to modify the “Channel Spacing” and “Occupied Bandwidth %Power” manually. The default value of “Channel Spacing” is 99.9% for “Occupied Bandwidth %Power”.

In Channel Measurement Menu, when user presses soft-key “Occupied Bandwidth”, the “Occupied Bandwidth” Menu will appear which is shown as below:

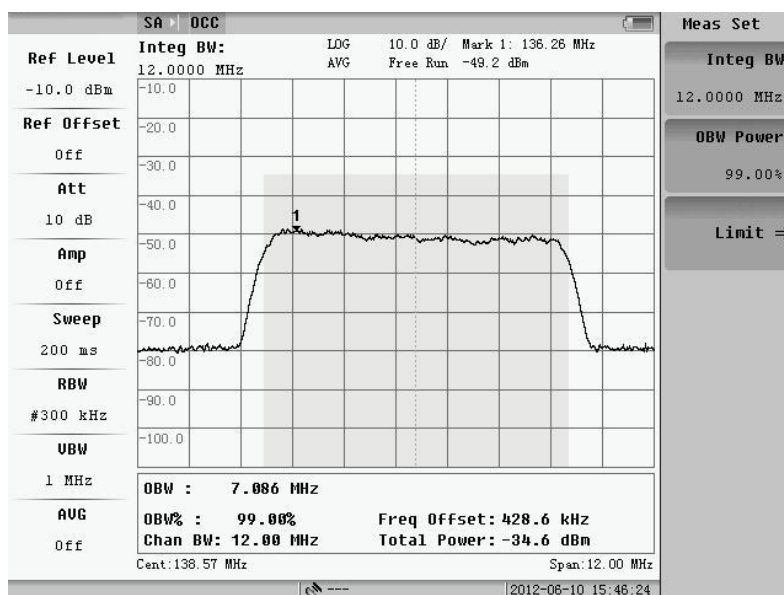

Fig.3.97 Occupied BW

In order to measure accurately, the scan span is fixed on three times of the channel Spacing. The analyzer scans

the setting span and calculates the total power first. Secondly find the greatest signal point, and set the difference of this signal frequency and the center frequency as “Fc” and display it on the screen. Finally little by little expand the power integral span around the greatest signal, until the equation the integral power equal to total power multiply the result of Occupied BW divide Power. The integral span is the OBW that displays on the screen. The same as the “Channel Power” measurement, user can use single scan and continuous scan function by selecting the soft-key “Single” and “Continuous”.

3.5.1 Basic measurement

1. Frequency

Pressing **Freq** key, the follow menu will pop up. User can set up centre frequency and step frequency for occupied BW measurement. The method of setup is same as the setup of Swept SA.

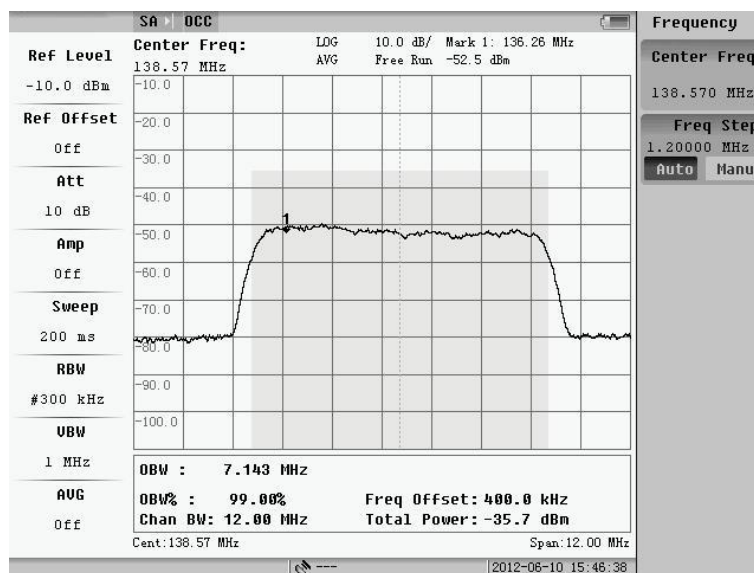

Fig.3.98 Frequency menu

2. Amplitude

Pressing **AMPTD** key, the follow menu will pop up.

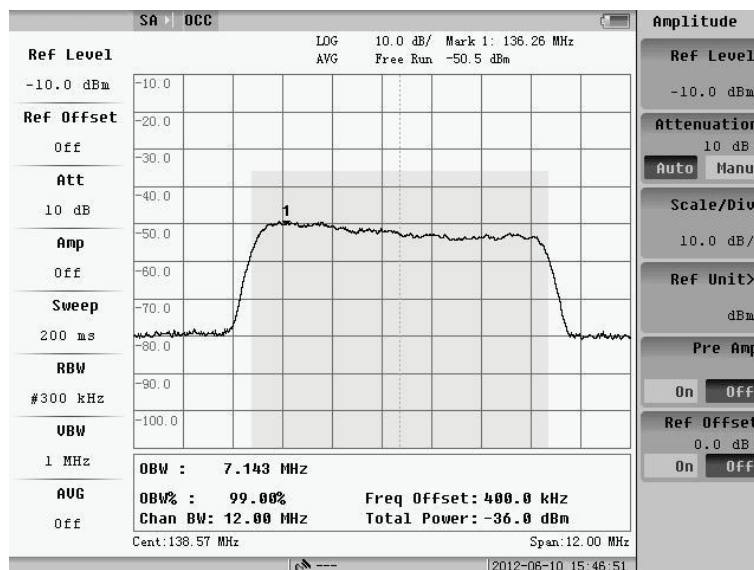

Fig.3.99 Amplitude menu

3.5.2 Basic parameter setup

The basic parameter setup of occupied BW is same as channel power setup; it is only about the video average and scan type. Other parameter such as resolution BW, video BW and scan time are configured by system default.

By pressing **CPL** key, change the basic parameter, and the follow menu of figure will appear:

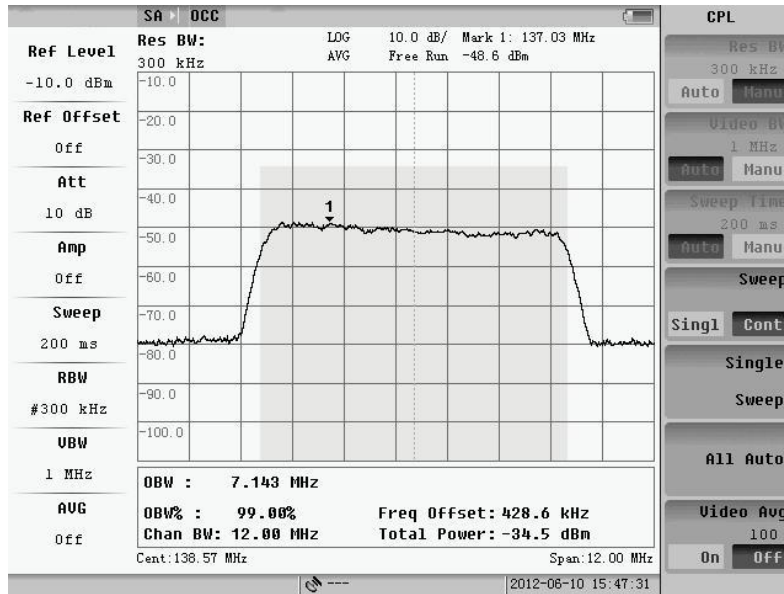

Fig.3.100 Basic parameter setting

3.5.3 Measurement parameter setup

User can set up some parameters by pressing **MEAS SETUP** key.

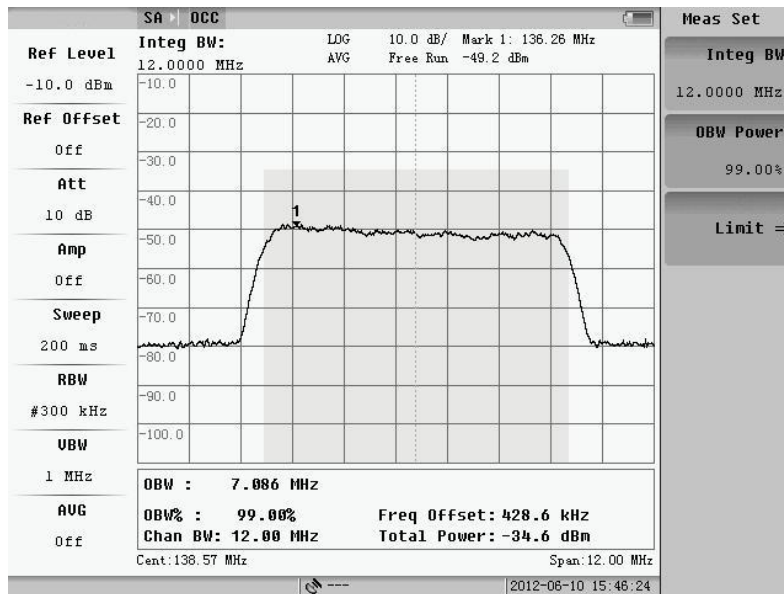

Fig.3.101 Measurement parameters setting

1. Channel BW

Press “Channel BW” key to change the value of channel BW. The default channel BW is 8MHz. In order to measure accurately, and the span frequency is set to 1.5 times the channel BW. Channel bandwidth is proportional to span. Therefore, span will be changed according to channel BW value. The channel bandwidth can also be changed by digital inputs, up and down key and knob.

2. Occupied Bandwidth %

Press "Occupied Bandwidth % key" to change the percent of Occupied Bandwidth. The default value is 99%. It can also be changed by digital inputs, up and down key and knob.

3. Limit

The setup of limit is shown as following figure.

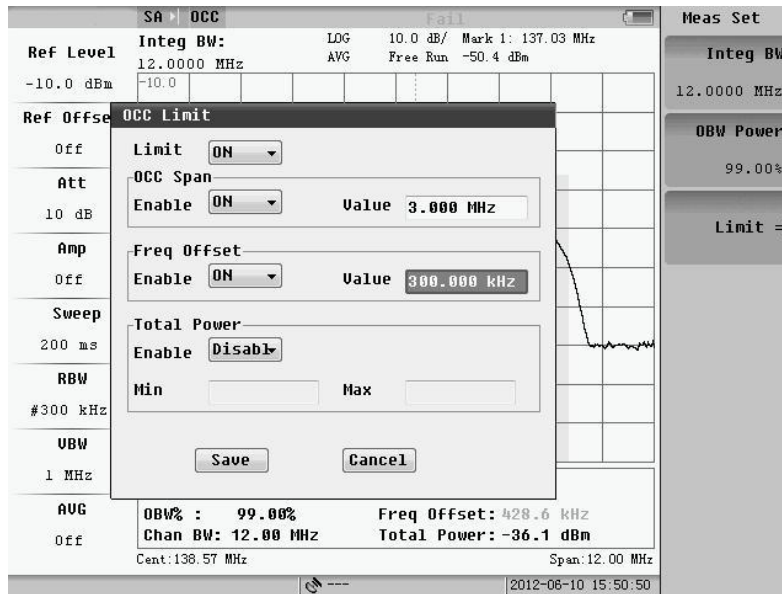

Fig.3.102 Limit value setting

The limit of occupied BW includes 3 items. User can enable limit line and input the value by limit dialog.

Only if the master switch is on, user can set up the limit value freedom.

When the limit value of occupied BW is the lower limit of occupied BW, and the value of occupied BW measurement is greater than the value, it is qualified.

When the limit value of center spectrum is the absolute value of the center-frequency offset, and frequency offset is less than the value, it is qualified.

When the value of channel power measurement is between the upper and lower limits, it is qualified.

The final result is passed only if each measurement item is qualified. Qualified, unqualified and disable are marked by green, red and white color.

3.5.4 Basic usage

The content is about marker and peak.

1. Marker Function

The Fig.3.103 will pop up after pressing **MARK** key. It is about normal mark and delta mark. The theory is same as spectrum scanning.

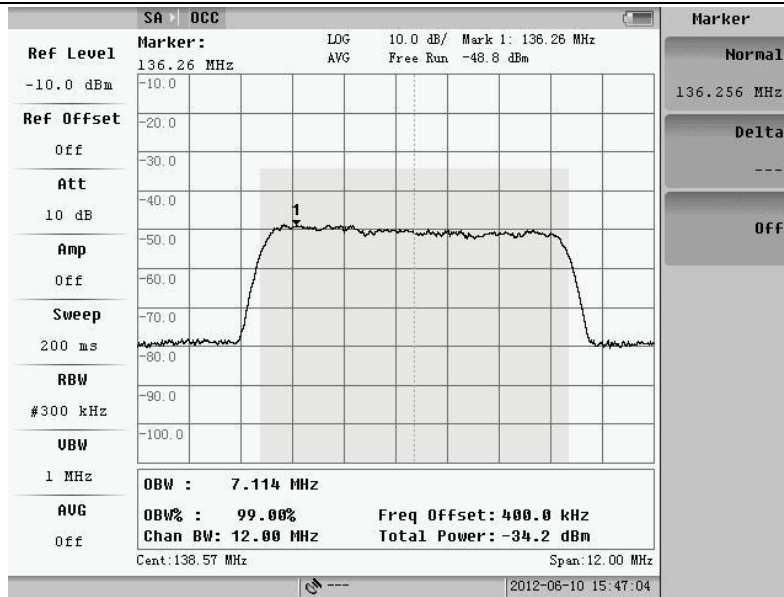

Fig.3.103 Mark menu

2. Peak Function

Pressing **PEAK** key, the menu will pop up as follow.

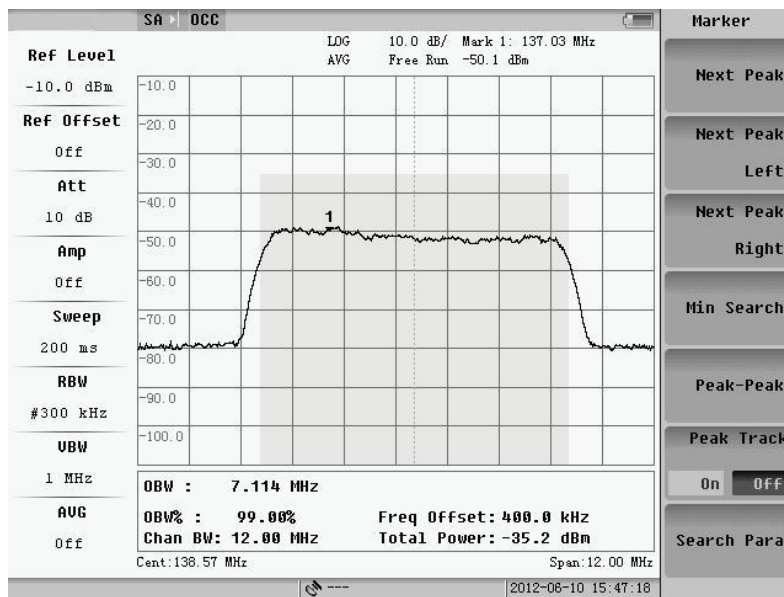

Fig.3.104 Peak menu

Peak function includes next peak, next left peak, next right peak, search condition, peak-peak and minimum value.

3.6 Field Strength

Field strength measurement refers to the level meter and the antenna, and the unit of measure is usually dBuV/m.

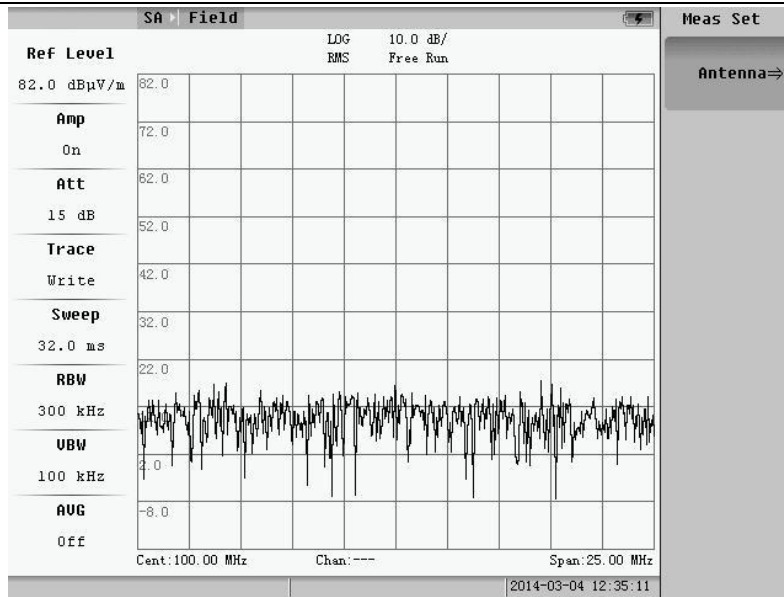

Fig.3.105 Field strength

1. Support unit: dBm/m², dBV/m, dBmV/m, dBµV/m, Volt/m, Watt/ m².
2. Three kinds of representation of antenna coefficient: Antenna gain Gain(G)[1/m], Antenna gain(g)[dBi], Antenna factor(AF)[dB(1/m)].
3. The basic measurements:

The figure will pop up after pressing **MARK** key. It is about normal mark and delta mark.

By pressing **CPL** key, change the basic parameter, the follow menu of figure will appear.

Pressing **FREQ AMPTD PEAK** to change the frequency, amplitude, peak.

3.7 FM/AM

Choose spectrum of FM/AM measurement, measurement into the interface.

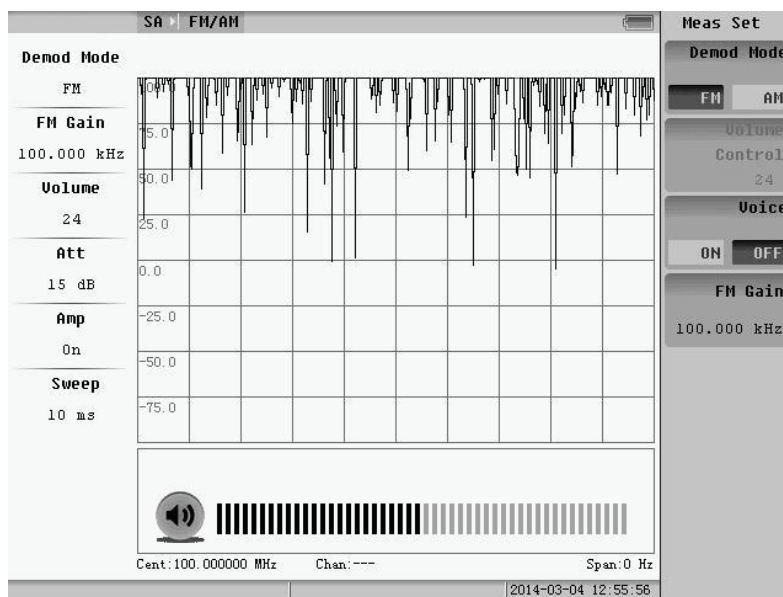

Fig.3.106 FM/AM

The basic measurements:

The figure will pop up after press **MARK** key. It is about normal mark and delta mark.

By pressing **CPL** key, and changing the basic parameter, the follow menu of figure will appear.

Press **FREQ AMPTD PEAK** to change the frequency, amplitude, peak.

Chapter 4 Interferometric Analysis

Press the **MODE** button, select the interference analysis of measurement model, and following menu will pop up shown as Fig.4.1:

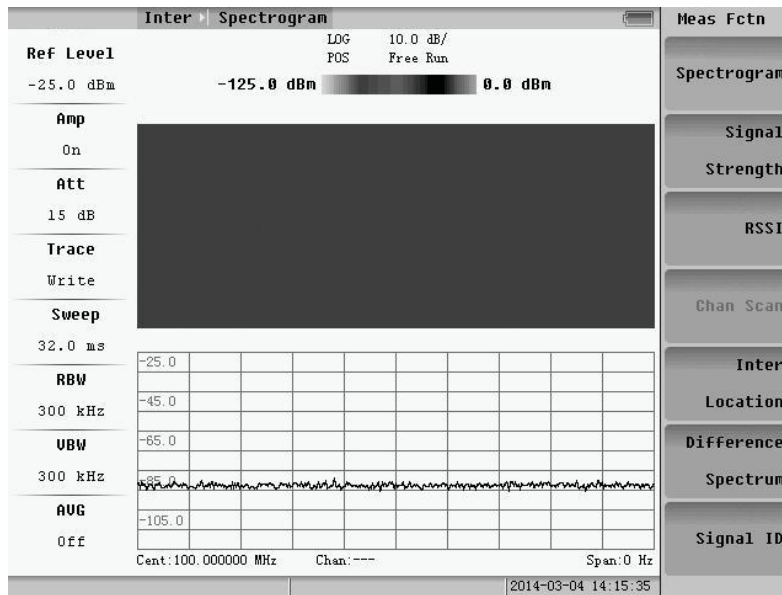

Fig.4.1 Interference analysis

4.1 Spectrogram

Pressing the spectrogram soft key, system will pop up shown as Fig.4.2 menu:

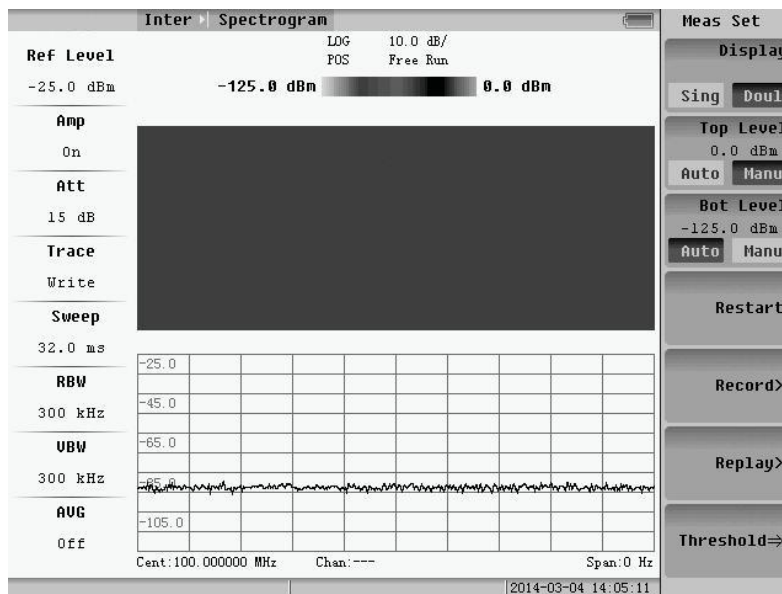

Fig.4.2 Spectrogram menu

Pressing the soft key of **Record** we can set Time Span, Interval, Data type and location, etc.

Display is used to switch the two modes of spectrogram, spectrum diagram and full screen display spectrogram.

Pressing the **FREQ PEAK AMPTD MARK CPL** function keys we can separately set frequency, PEAK, amplitude, frequency and other basic settings.

4.2 Signal Strength

Pressing the **MEAS** and selecting signal strength measuring interface shown as Fig.4.3 will pop up.

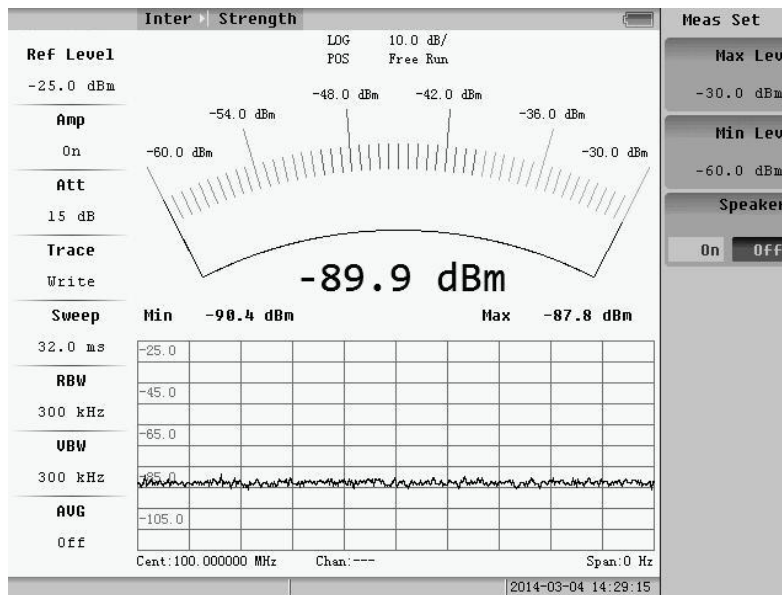

Fig.4.3 Signal strength menu

Signal strength is used to measure dot frequency signal strength. The largest scale and the minimum scale are used to set the current the range of the signal strength.

Press the **FREQ AMPTD CPL** function keys, and then we can do frequency, amplitude, and other basic settings.

4.3 RSSI

Pressing the **MEAS** and selecting RSSI measuring interface shown as Fig.4.4 will pop up:

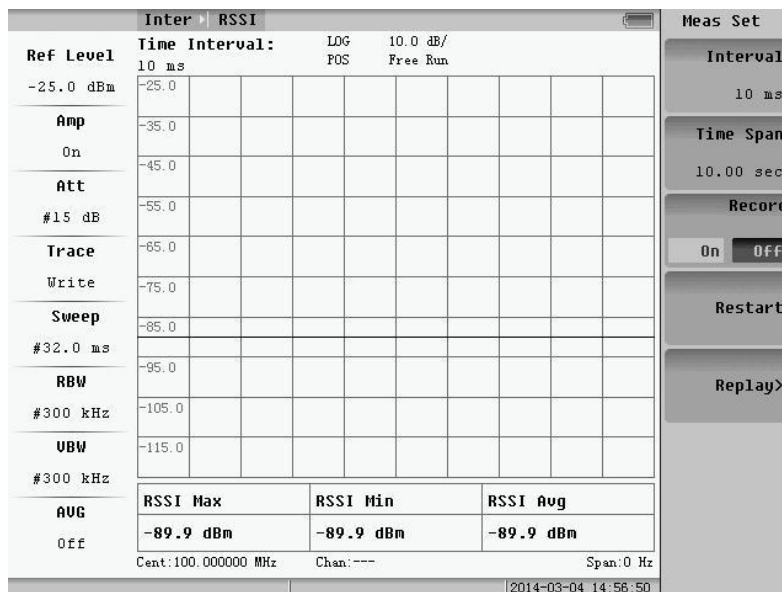

Fig.4.4 RSSI measurement menu

This function can realize the record of a particular frequency point in time.

Open **record** and record system will automatically file name "Years on - - - - second" format.

Replay can choose the history file to replay, shown as Fig.4.5:

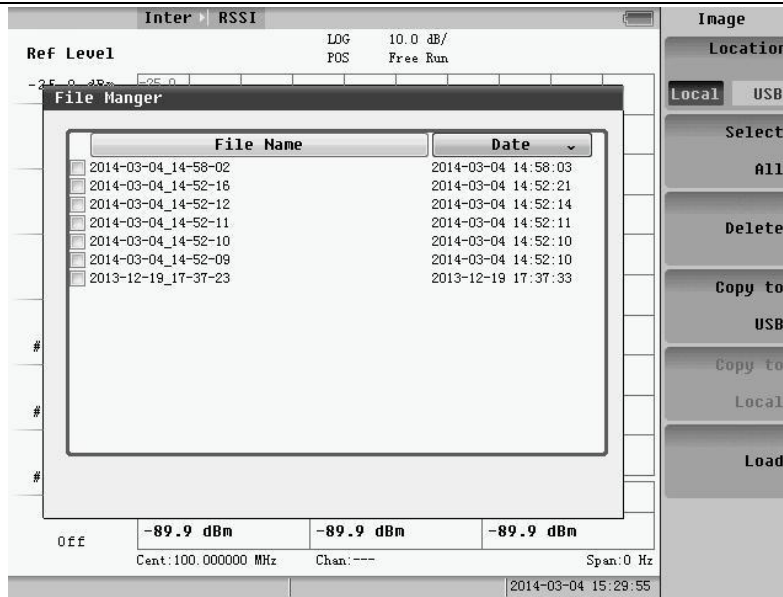

Fig.4.5 Replay choose

4.4 Channel Scan

Pressing the **MEAS** and selecting Chan Scan measuring interface shown as Fig.4.6 will pop up.

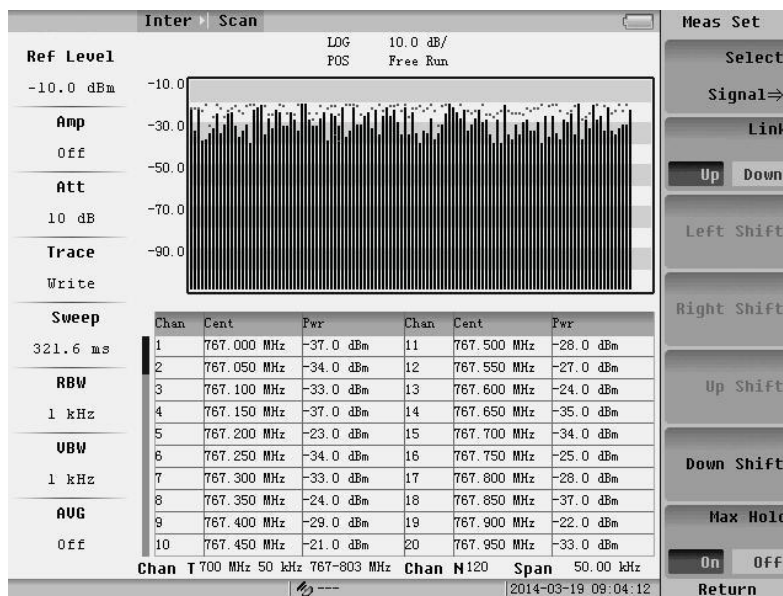

Fig.4.6 Measuring interface

Pressing the **PEAK AMPTD CPL** function keys back, amplitude, frequency and other basic settings can be done separately.

4.5 Interference Localization

Pressing the **MEAS** and selecting Inter Location measuring interface shown as Fig.4.7 will pop up.



Fig.4.7 Interference localization

Frequency spectrographs can be located after installing GPS positioning, and browse map. Press **FREQ AMPTD CPL** to change the frequency, amplitude, and other basic Setting.

4.6 Difference Spectrum

Pressing the **MEAS** and selecting Difference spectrum measuring interface will pop up shown as Fig.4.8.

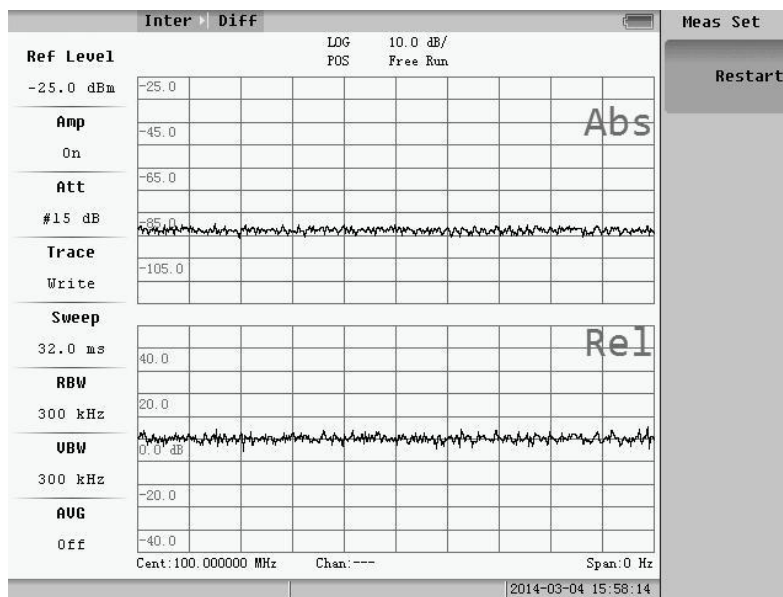

Fig.4.8 Difference spectrum

Press the **PEAK AMPTD MARK CPL** function keys to set PEAK, amplitude, frequency and other basic settings separately.

4.7 Signal ID

Pressing the **MEAS** and selecting Signal ID measuring interface will pop up shown as Fig.4.9.

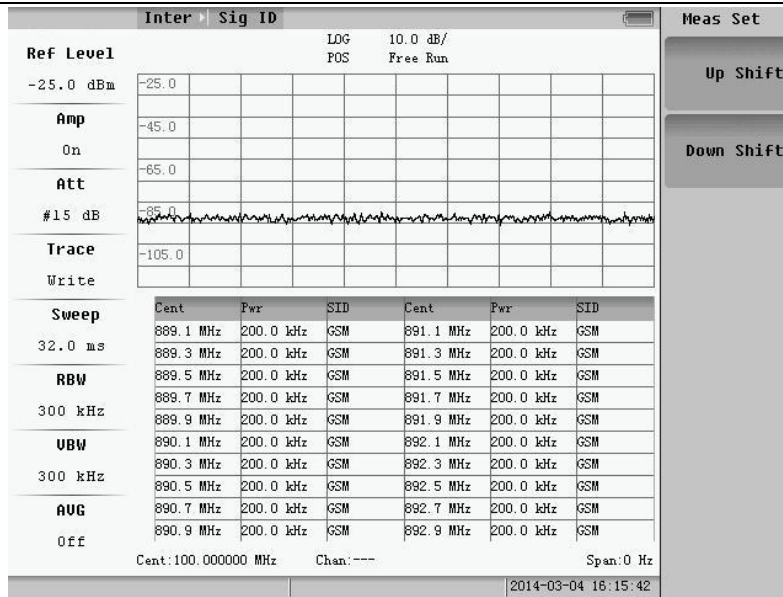

Fig.4.9 Signal ID

Press the **FREQ PEAK AMPTD MARK CPL** function keys to set frequency, PEAK, amplitude, mark and other basic settings separately.

Chapter 5 Basic Stations Analyzer

Pressing the MODE button, and selecting the BS Analyzer of measurement model, menu will pop up shown as Fig.5.1.

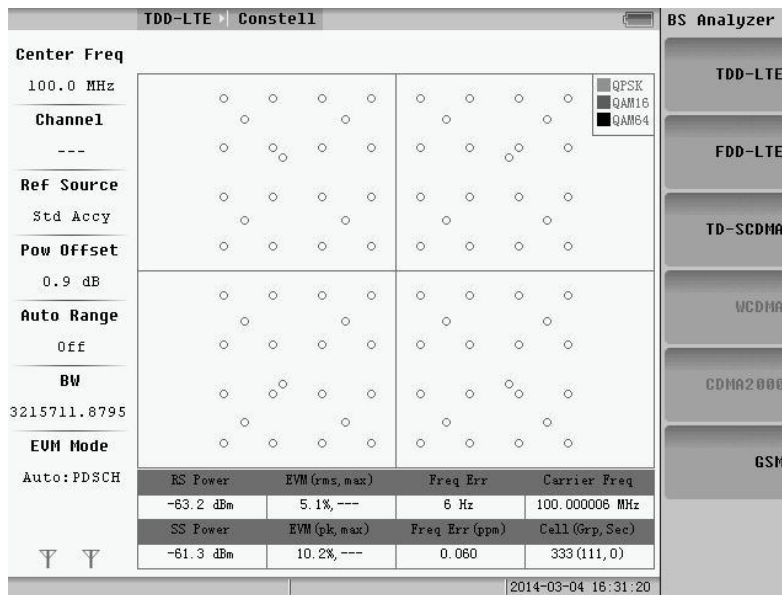

Fig.5.1 BS analyzer menu

5.1 TDD-LTE

Select TDD-LTE soft-key to enter TDD-LTE menu, shown as the following pictures.

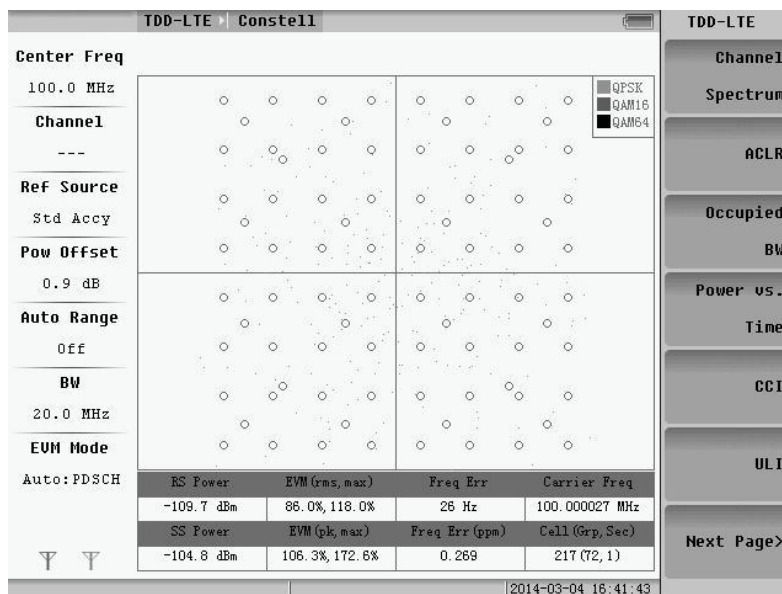

Fig.5.2 TDD - LTE menu (page 1)

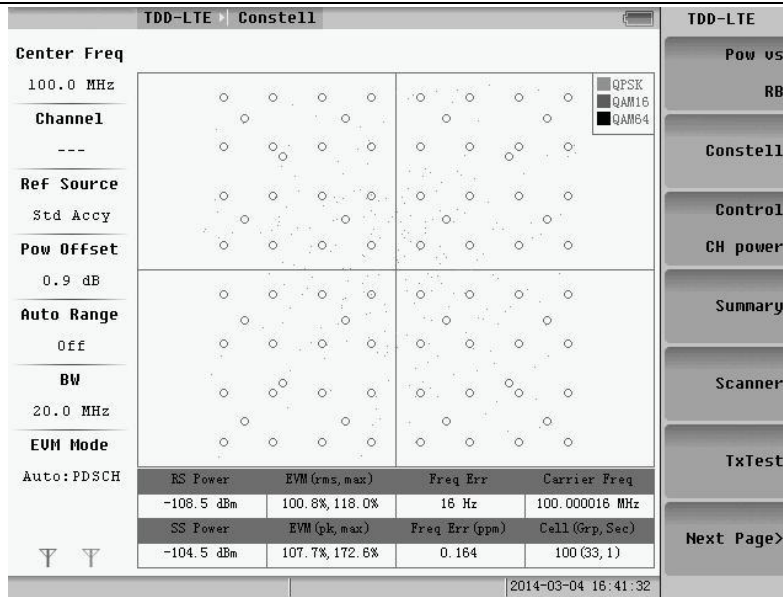

Fig.5.3 TDD - LTE menu (page 2)

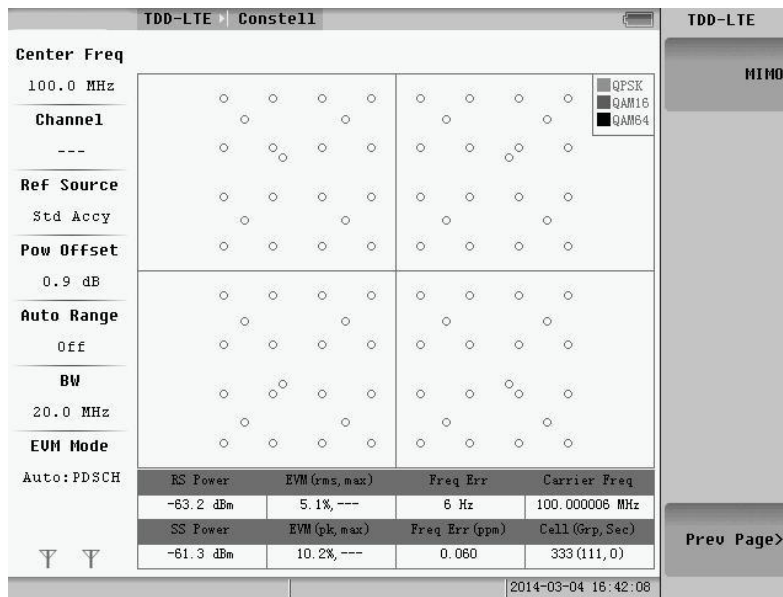

Fig.5.4 TDD - LTE menu (page 3)

5.1.1 Power vs. Resource block

Press the Pow vs RB soft key, and enter into the menu of Pow vs RB, shown as the following figure:

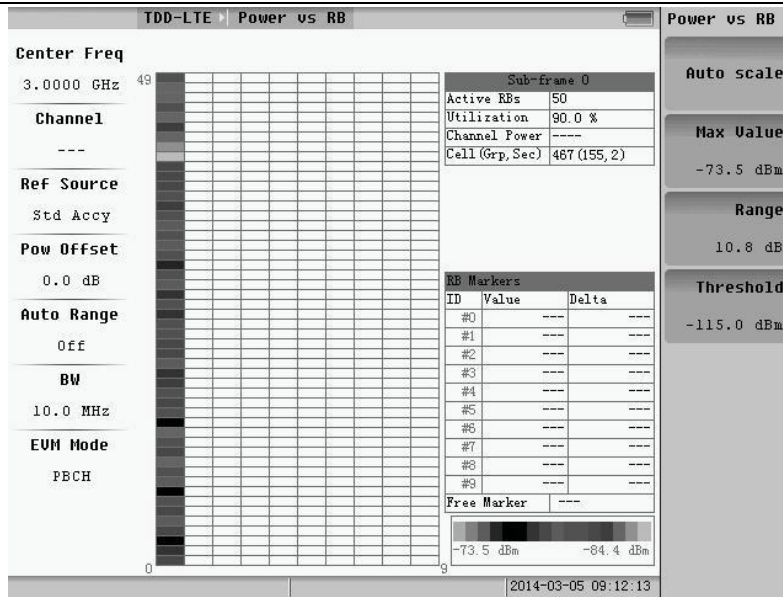

Fig.5.5 Pow vs RB menu

1) Auto scale

Select the “Auto scale” to get RB power color images automatically.

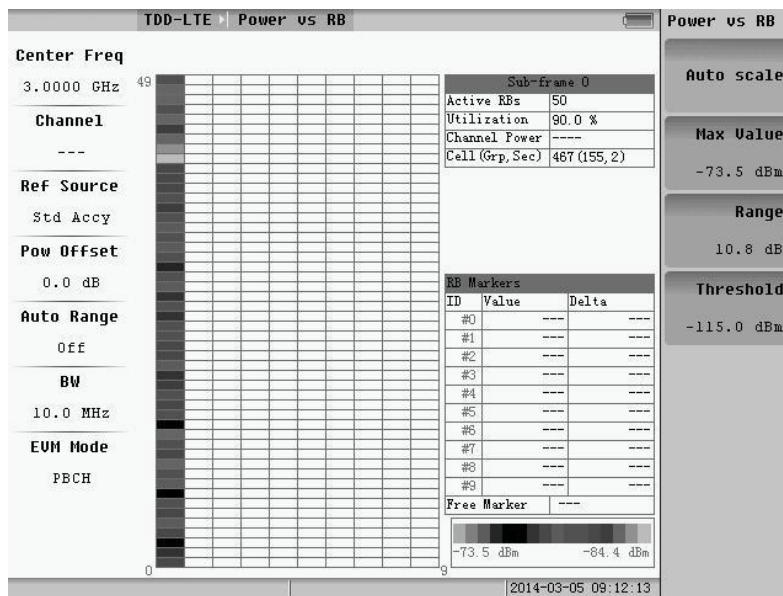

Fig.5.6 Auto scale

2) Max value, Range and Threshold

Choose the “Max Value”, “Range” or “Threshold” to set the power of the RB.

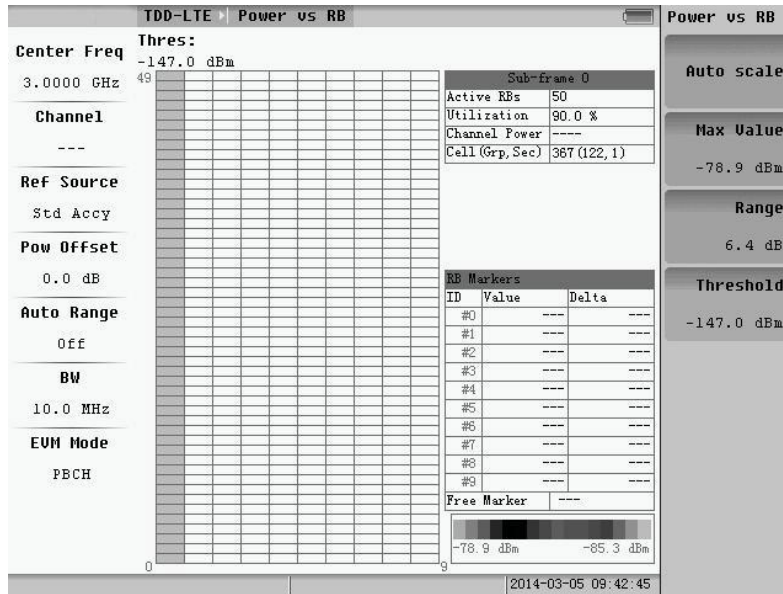

Fig.5.7 Set RB manually

3) Pressing the **FREQ AMPTD** function keys can set frequency and amplitude separately.

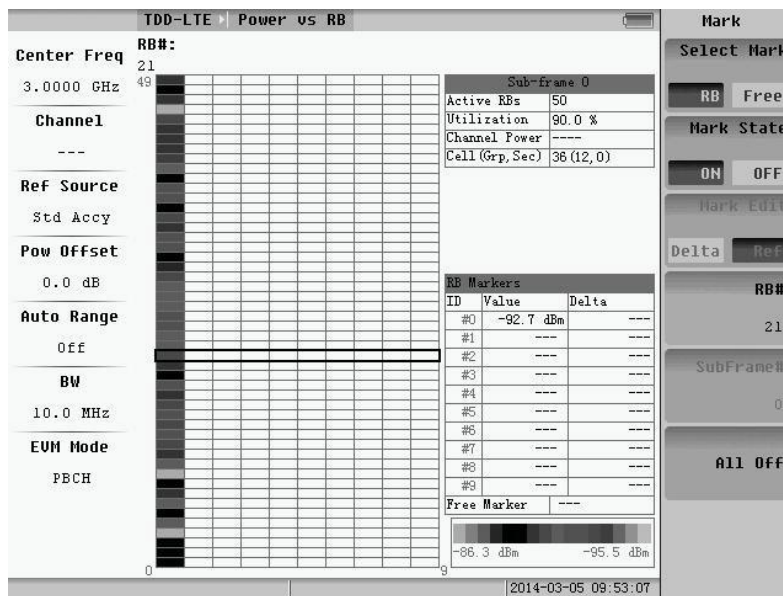

Fig.5.8 Mark the RB

4) Pressing the **MARK** key can mark the Resource Block and SubFrame.

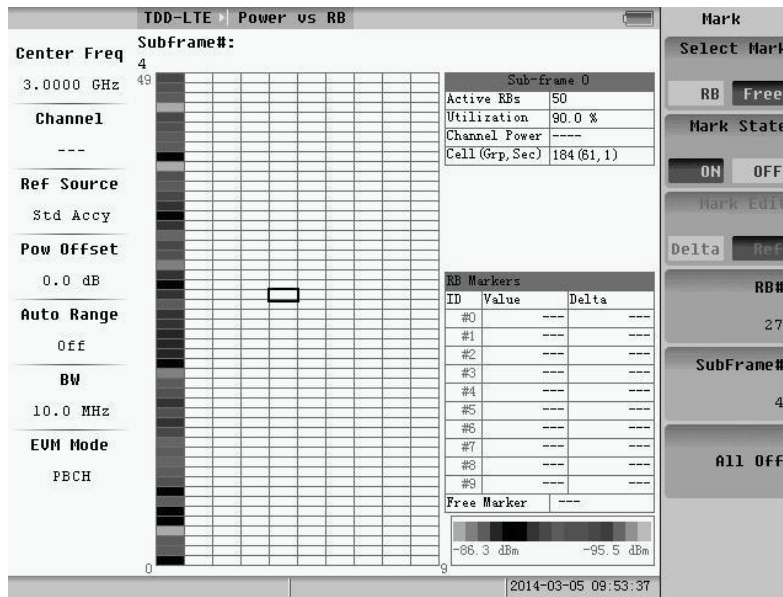

Fig.5.9 Mark the subFrame

5) Pressing the **MEAS SETUP** key can set the basic parameter. Choose the bandwidth, open or close the EVM Max Hold, select the EVM Mode and open or close every channel. It is same as that in the following measures.

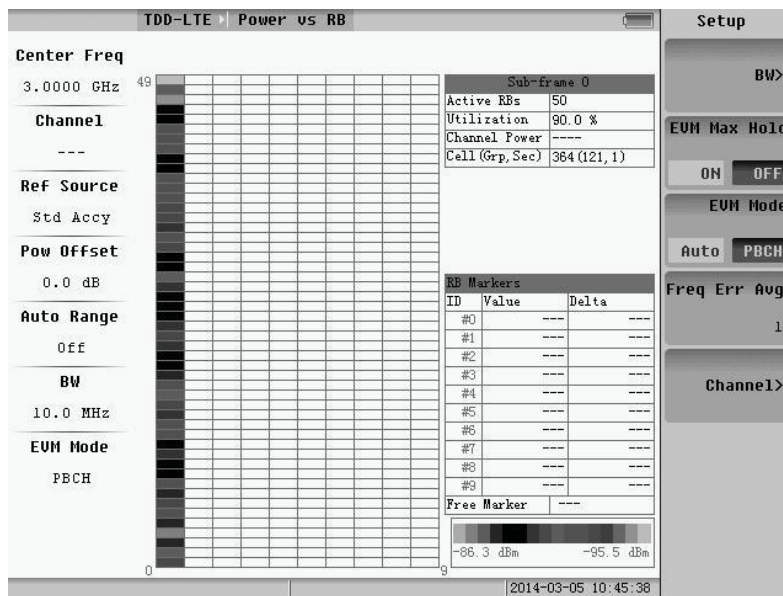

Fig.5.10 Setup

6) Pressing the **PEAK** key can peak search, and find the SubFrame of the Free Marker's max value.

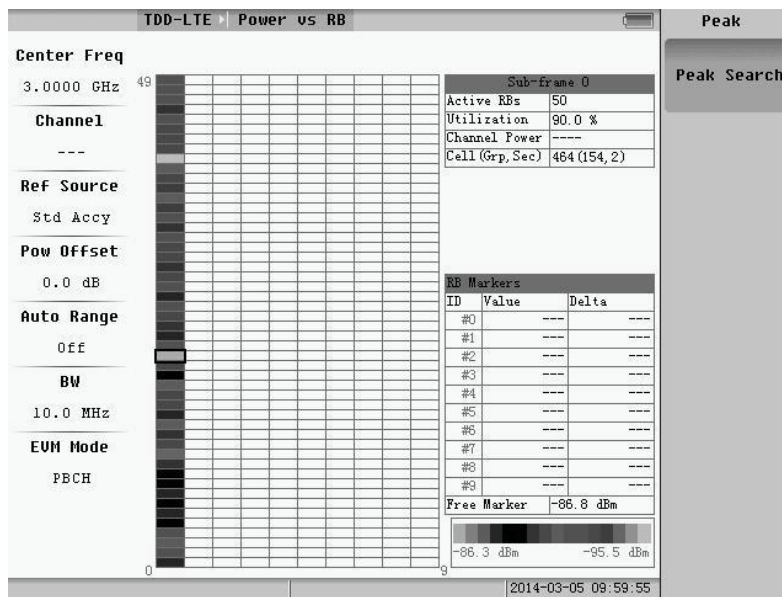

Fig.5.11 Peak search

5.1.2 Constellation

Select “Constell” to enter the menu, shown as the following figure.

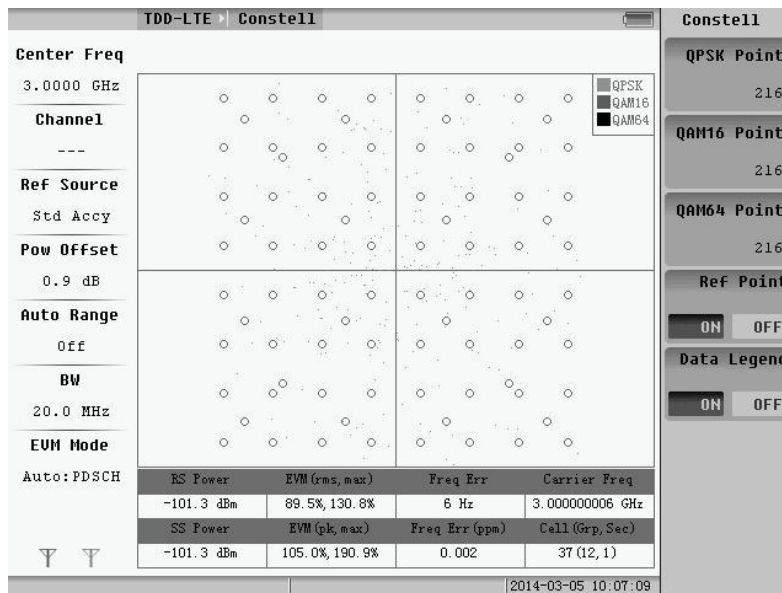

Fig.5.12 Constellation menu

1) QPSK points, QAM16 Point and QAM64 points

These buttons are used to set the number of points.

2) Reference Point and Data Legend

Press the “Ref Point” key, and set the Reference Point open or off, the same as “Data Legend”.

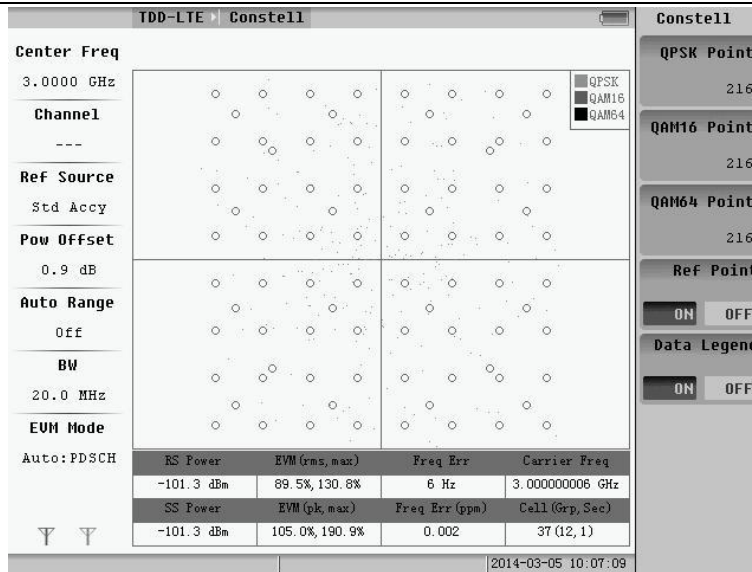

Fig.5.13 Reference point and data legend open

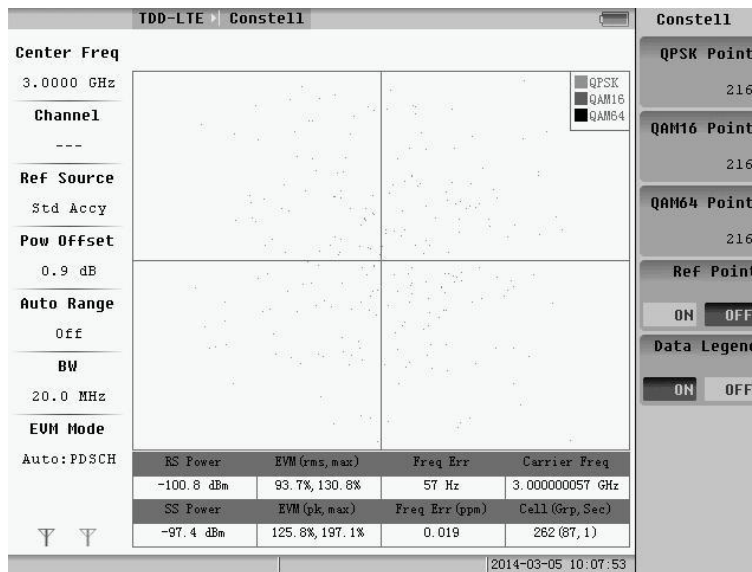

Fig.5.14 Reference point off

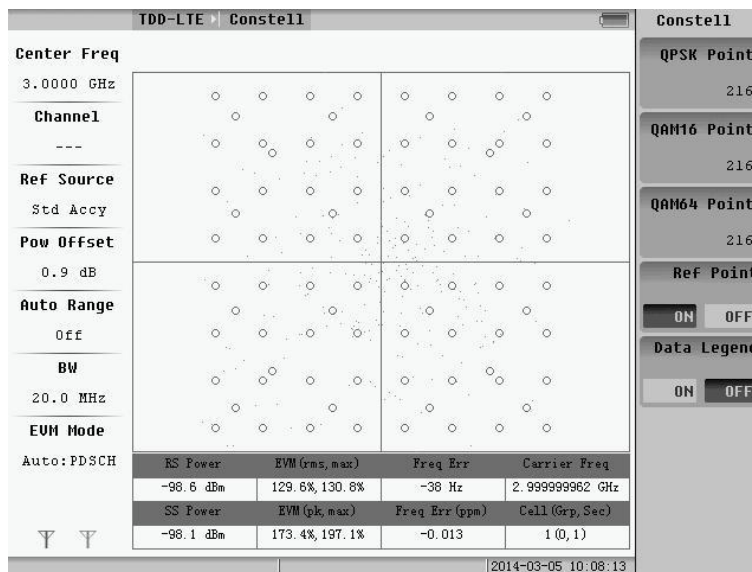

Fig.5.15 Data legend off

3) Pressing the **FREQ AMPTD MEAS SETUP** function keys can set frequency, amplitude, and means separately.

5.1.2 Control channel power

Select the “Control CH Power” into the Control channel Power mode. The menu is the setup menu.

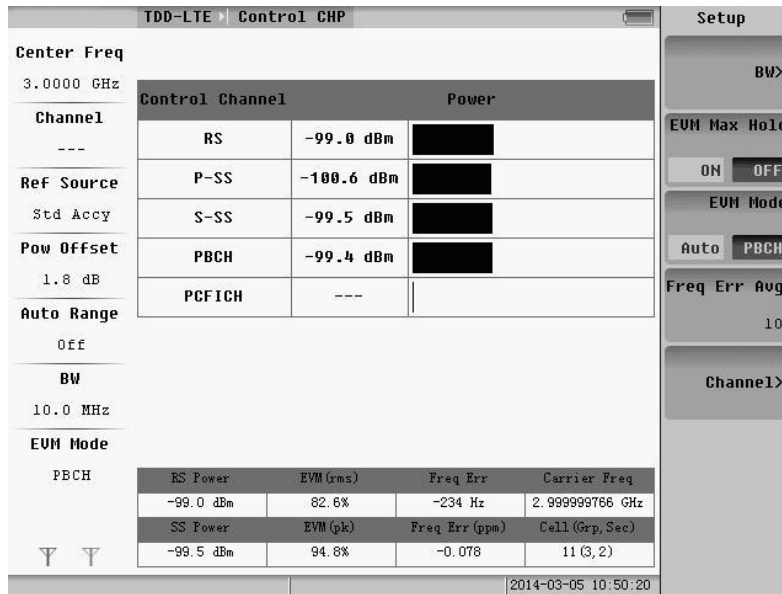

Fig.5.16 Control CH power measure

Pressing the **FREQ AMPTD** function keys can set frequency and amplitude separately.

5.1.3 Summary

Select the “Summary” in the Control channel Power mode. The menu is the setup menu.

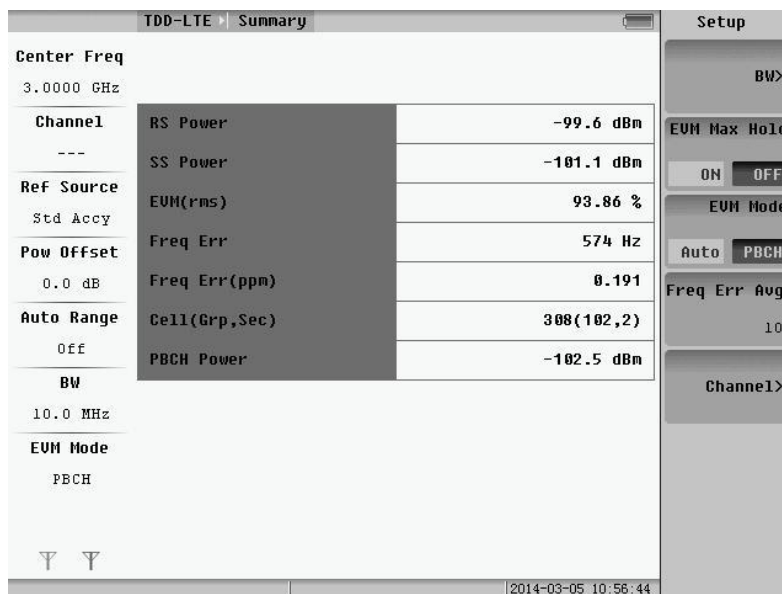

Fig.5.17 Summary measure

Pressing the **FREQ AMPTD** function keys can set frequency and amplitude separately.

5.1.4 OTA scanner

The menu is shown as below.

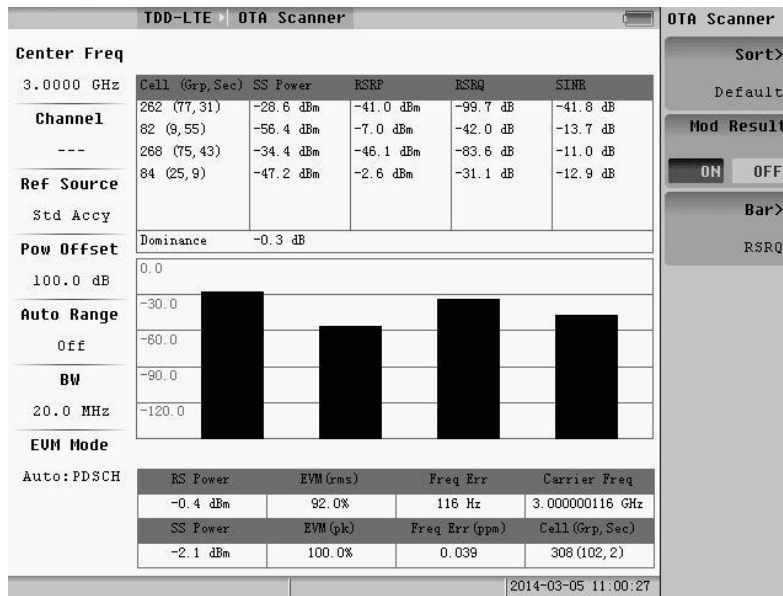

Fig.5.18 OTA scanner menu

1) Sort

Select the method and the selected numbers order by value.

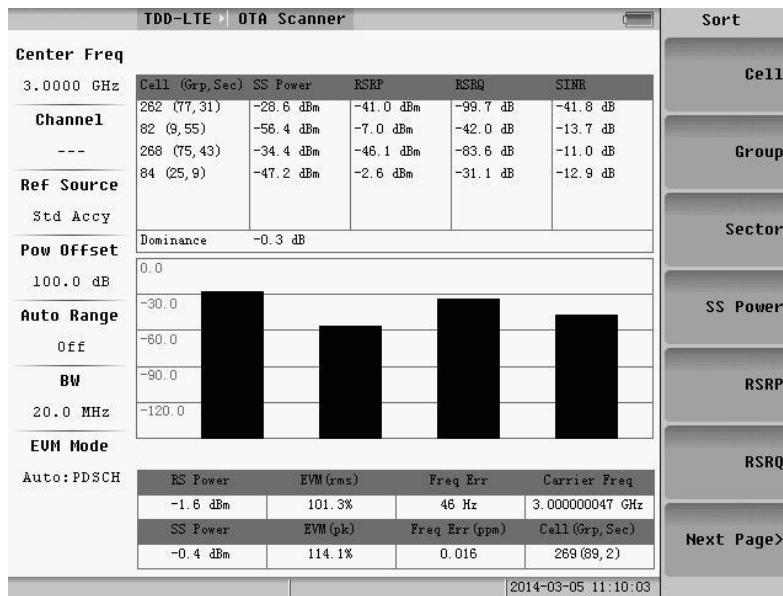

Fig.5.19 Selection of sort (page 1)

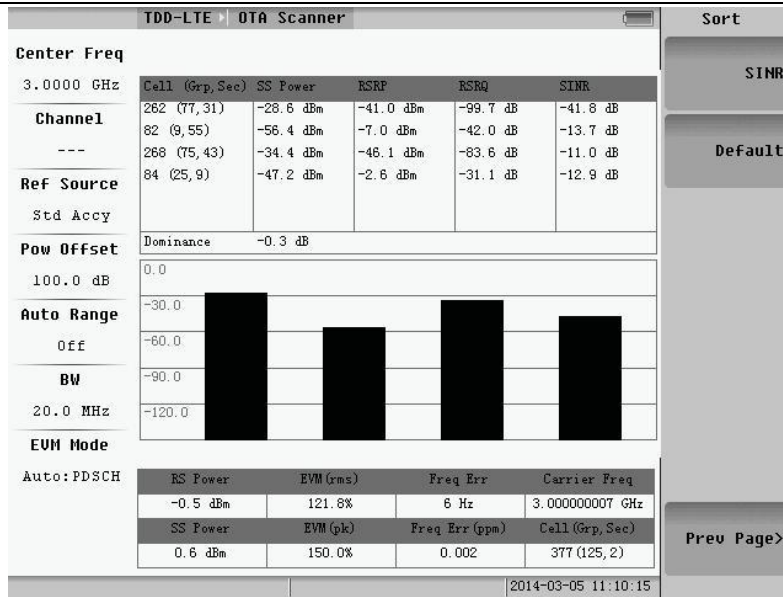

Fig.5.20 Selection of sort (page 2)

2) Modulation results

“Mod Result” can set the modulation results to open or close.

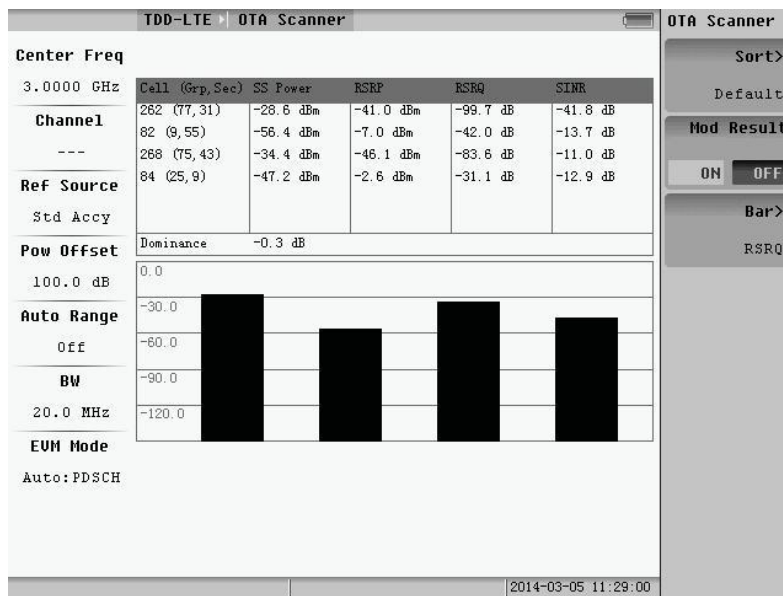

Fig.5.21 Mod Result close

3) Bar

Select "Bar >" to enter the submenu of bar, shown as Fig.5.22 .

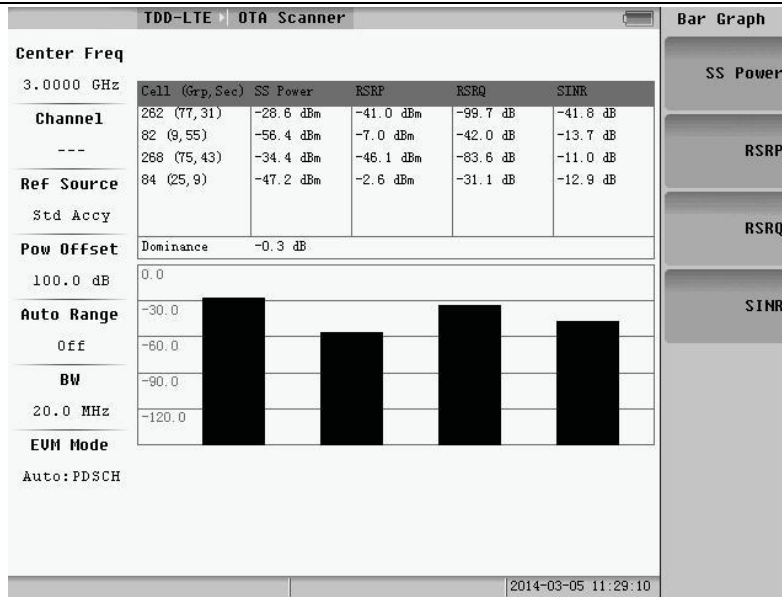

Fig.5.22 Selection of Bar

4) Pressing the **FREQ AMPTD MEAS SETUP** function keys can set frequency, amplitude and means separately.

5.1.5 Tx Test

Tx Test measurements are optimized for remote radio heads and MIMO systems. The first table in Tx Test replicates the Scanner table measurements except the measurement scans the presence of up to 3 cell IDs. The second table shows the RS power across all detected antennas (transmitters) for the strongest Cell ID. This is displayed as average power and delta power for the detected transmitters, along with a small bar graph that shows the relative RS powers for each Tx. The PBCH Modulation Results table can also be turned on.

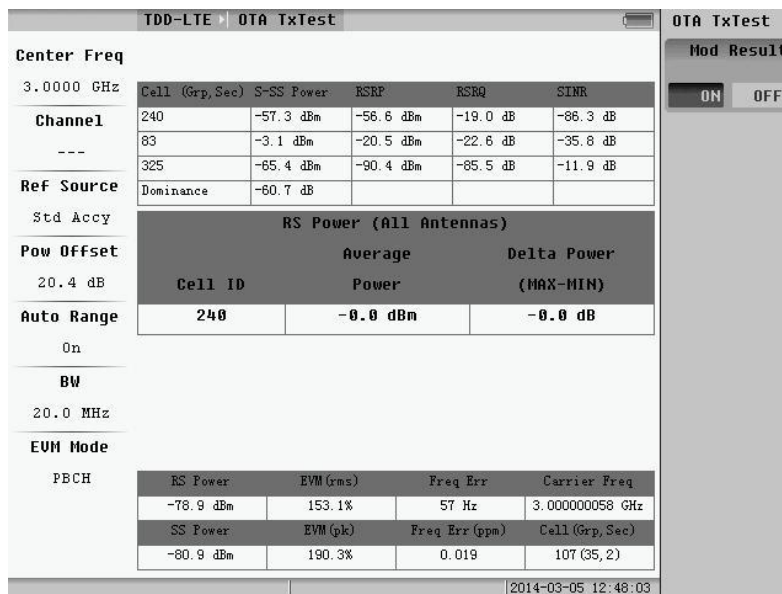

Fig.5.23 Tx Test measure

“Mode Result” can set the modulation results to open or close.

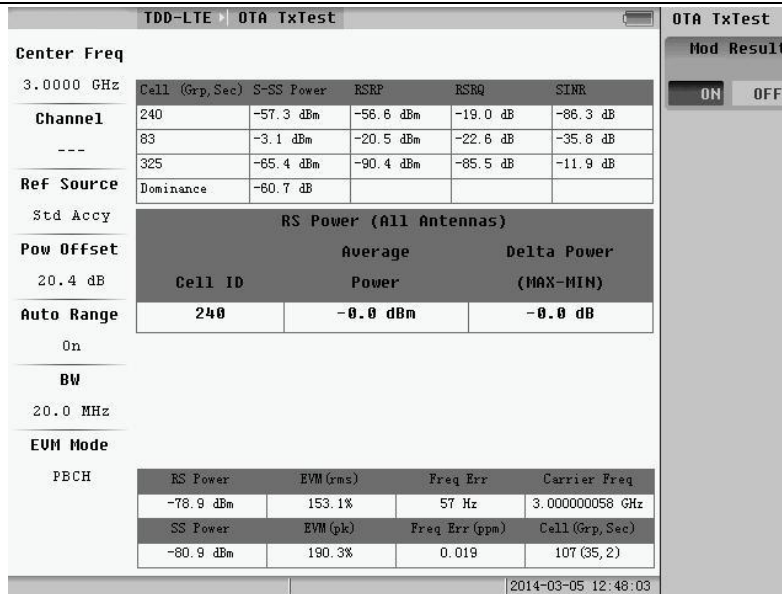

Fig.5.24 Mod Result close

Pressing the **FREQ AMPTD** function keys can set frequency and amplitude separately.

5.1.6 Channel Power

Select the “Channel Spectrum” to enter the submenu.

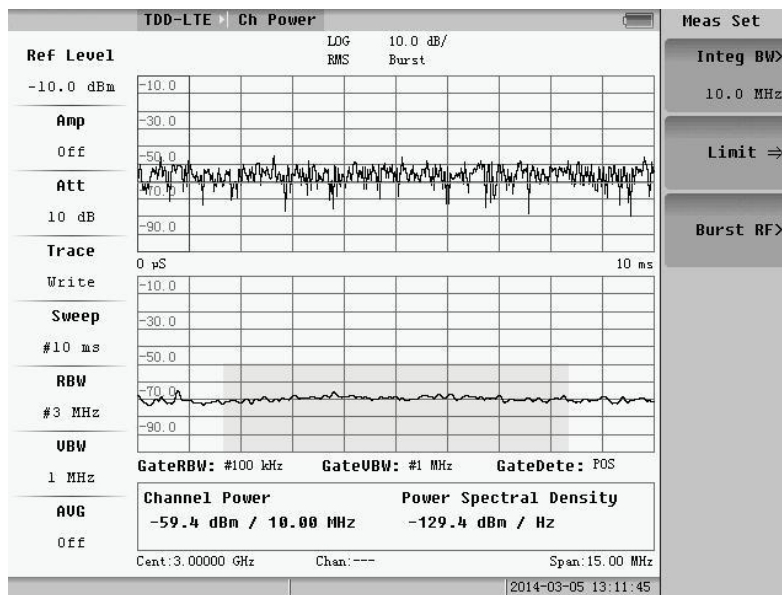

Fig.5.25 Channel power menu

The Channel Power in the mode of TDD-LTE is basically the same as that in Spectrum Analyzer.

5.1.7 ACLR

Select the “ACLR” to enter submenu.

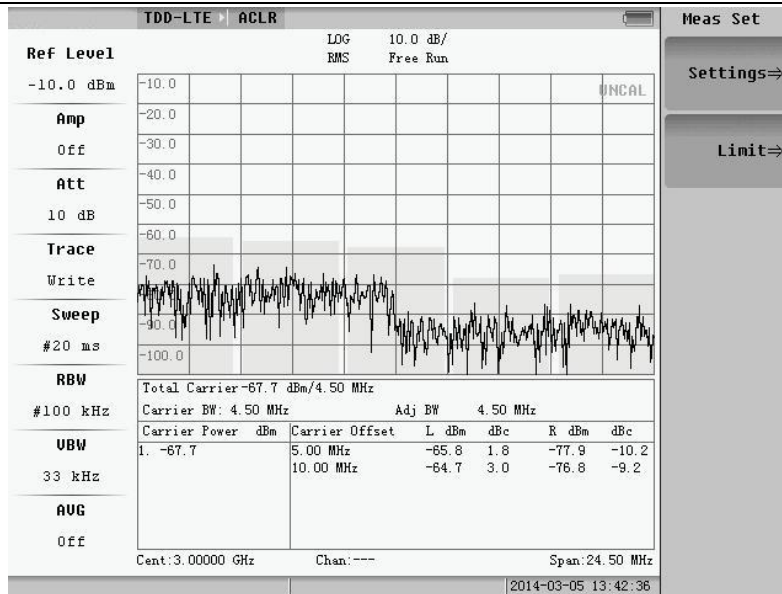

Fig.5.26 ACLR menu

Choose the “Setting=>” or “Limit=>”; the window will pop up; and you can set the parameter. The ACLR in the mode of TDD-LTE is basically the same as that in Spectrum Analyzer.

5.1.8 Occupied bandwidth

Select the “Occupied BW” to enter submenu.

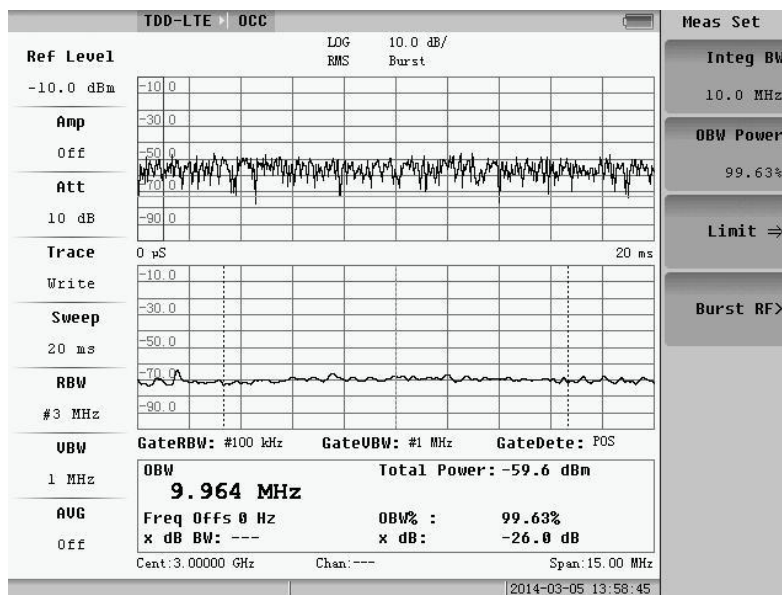

Fig.5.27 Occupied BW menu

The Occupied BW in the mode of TD-LTE is t basically the same as that in Spectrum Analyzer.

5.1.9 Power vs. Time

Select the “Power vs. Time” to enter submenu.

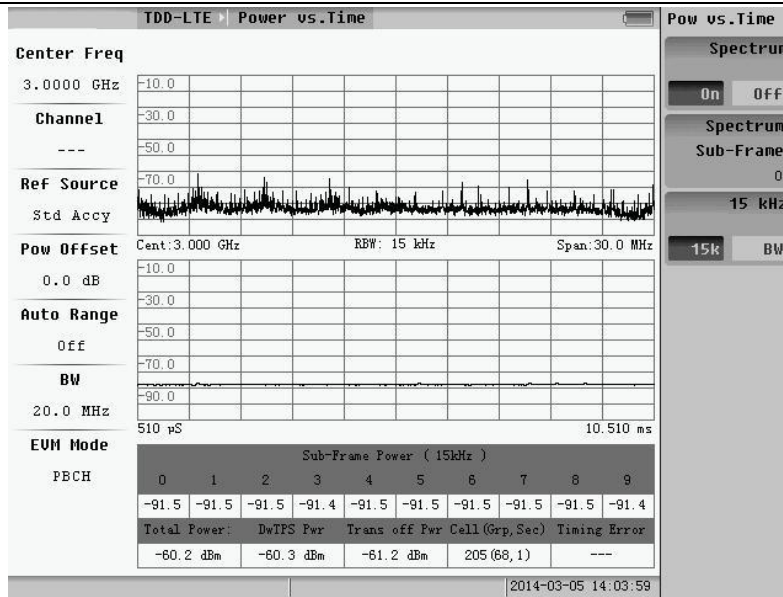

Fig.5.28 Power vs. Time menu

Spectrum: Press to select either Frame or Sub-Frame.

Spectrum sub-Frame: If Sub-Frame is opened, press to enter the desire sub-frame to Spectrum.

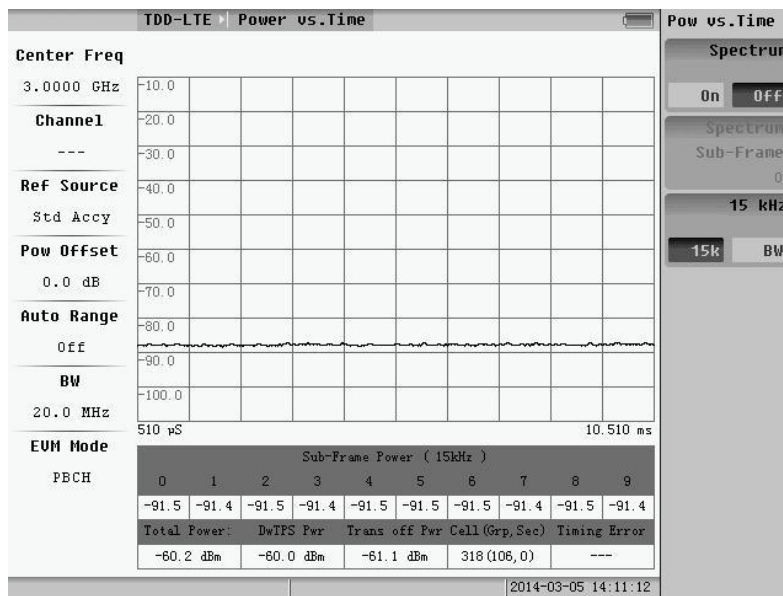

Fig.5.29 Spectrum close

Pressing the **FREQ PEAK AMPTD MARK** function keys can set frequency, PEAK, amplitude and mark separately.

5.1.10 CCI

Select the “CCI” to enter submenu.

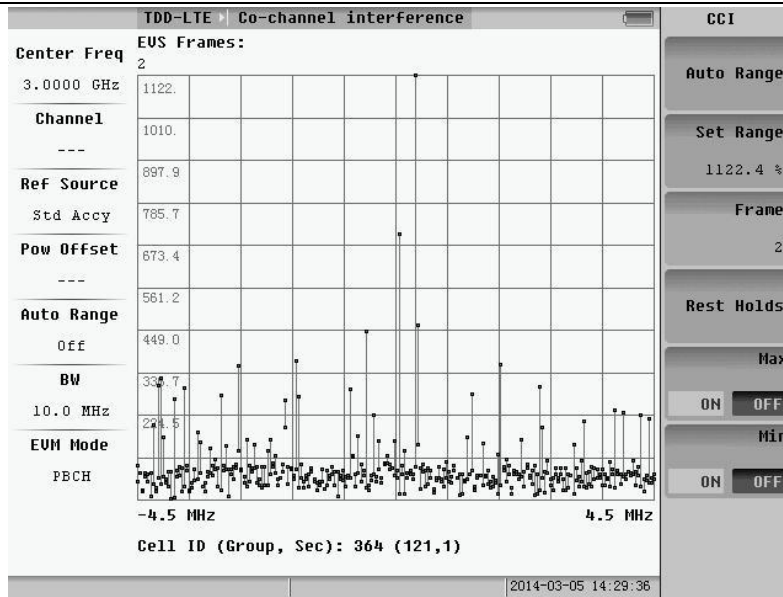

Fig.5.30 CCI menu

Frame: change the value of Frame, which is 1 or 2.

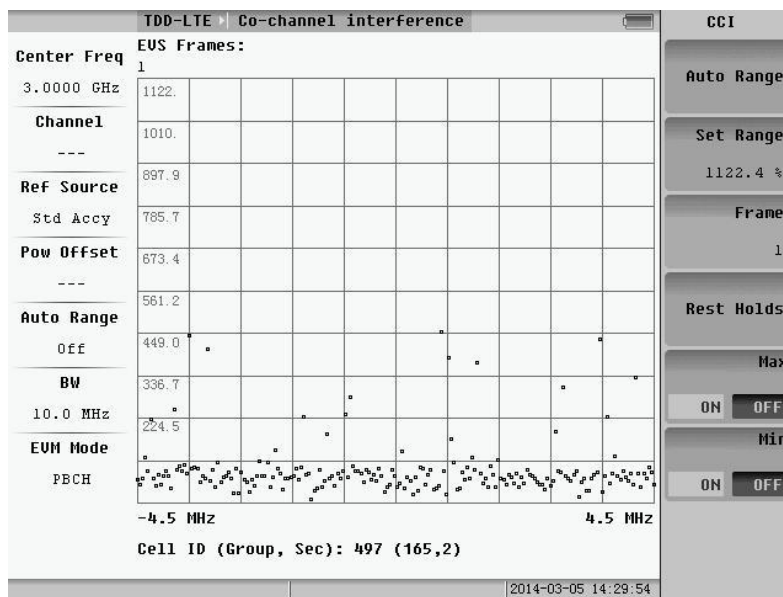

Fig.5.31 One frame

Max: Press to open or close max holds.

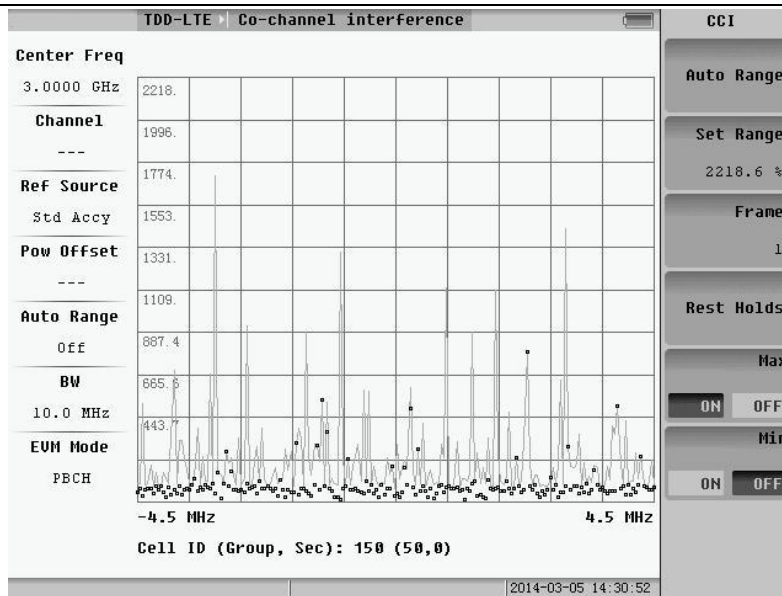

Fig.5.32 Max. holds

Min: Press to open or close min holds.

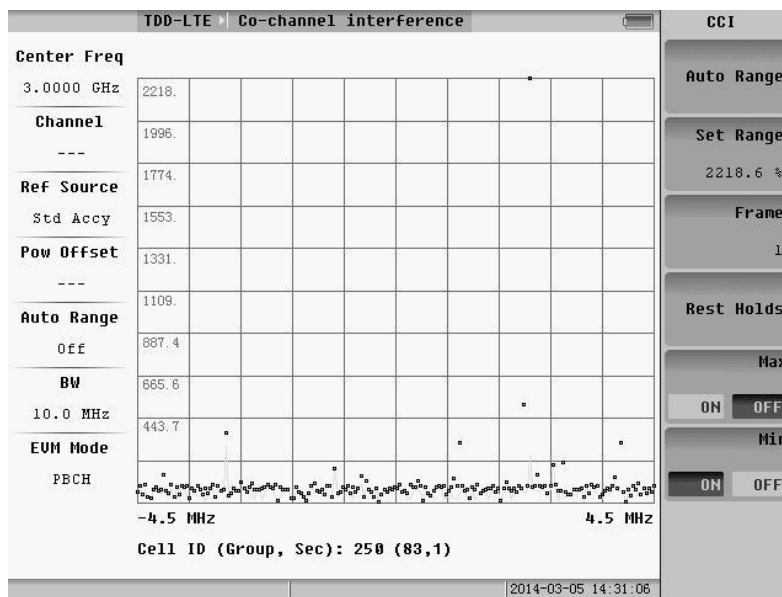

Fig.5.33 Min. holds

Rest Holds: Remove max and min holds, and then hold again.

Pressing the **FREQ AMP TD MARK** function keys can set frequency, amplitude and mark separately.

5.1.11 ULI

Select the “ULI” to enter submenu.

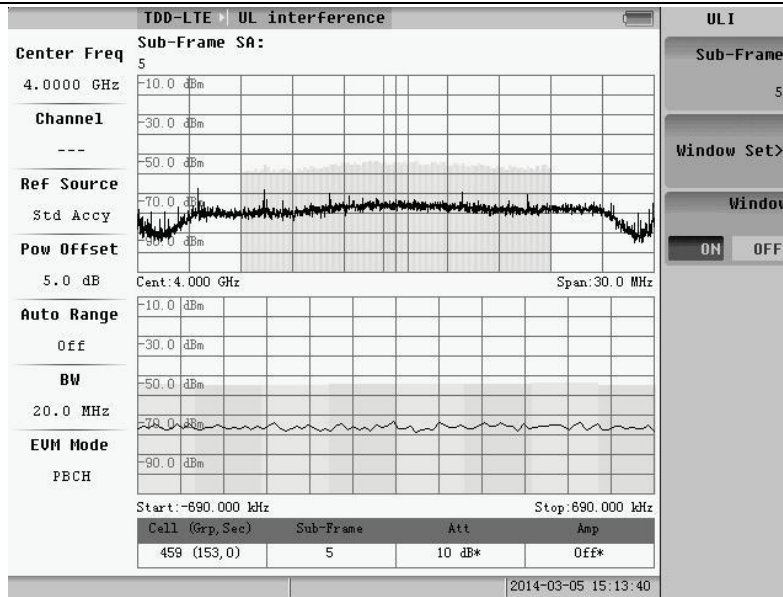

Fig.5.34 ULI menu

Menu Sub-Frame: input needed sub-frame number.

Window Set: set the parameters of the window.

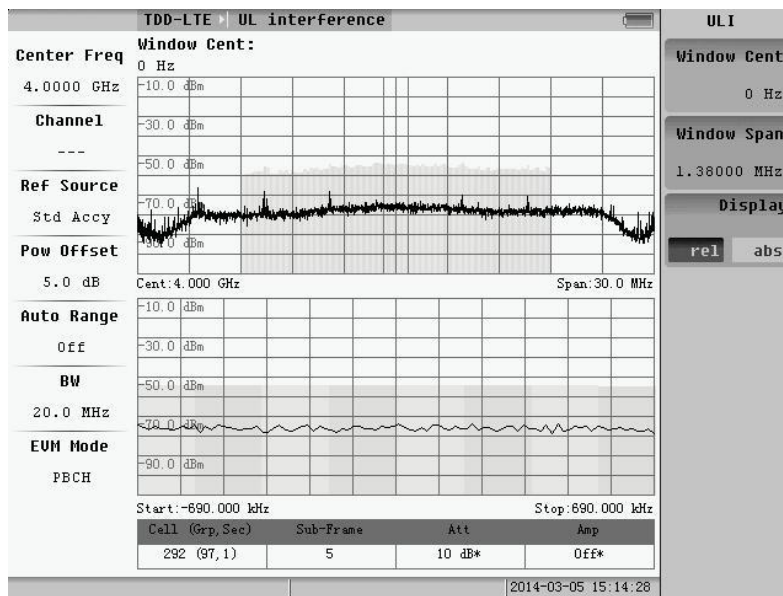

Fig.5.35 Window set menu

Window: press to open or close the window.

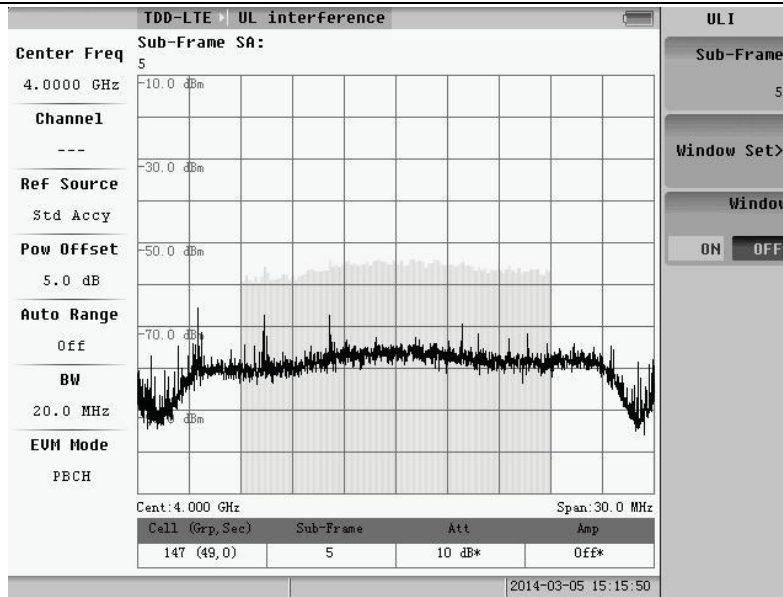

Fig.5.36 Window closed

Press the **FREQ PEAK AMPTD MARK** function keys to set frequency, PEAK, amplitude and mark separately.

5.1.12 MIMO

Select the “MIMO” to enter submenu.

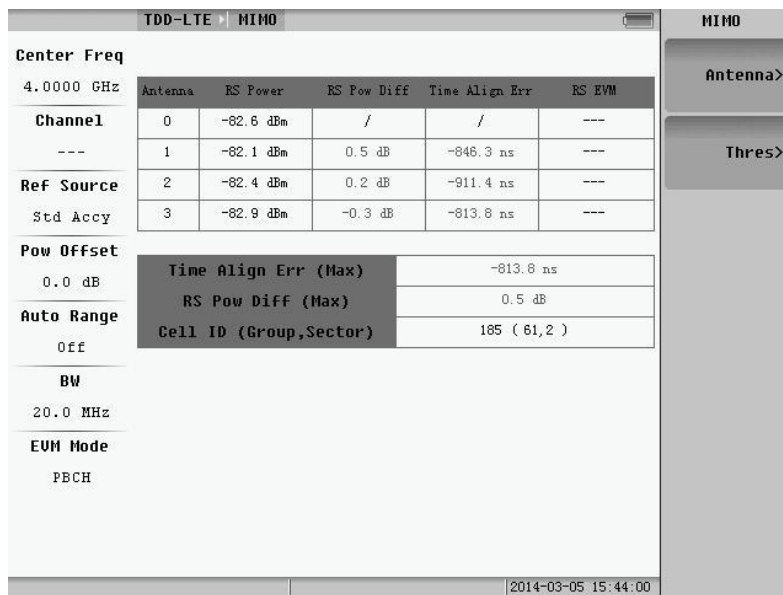

Fig.5.37 MIMO menu

Antenna: press the submenu to select the antenna number.

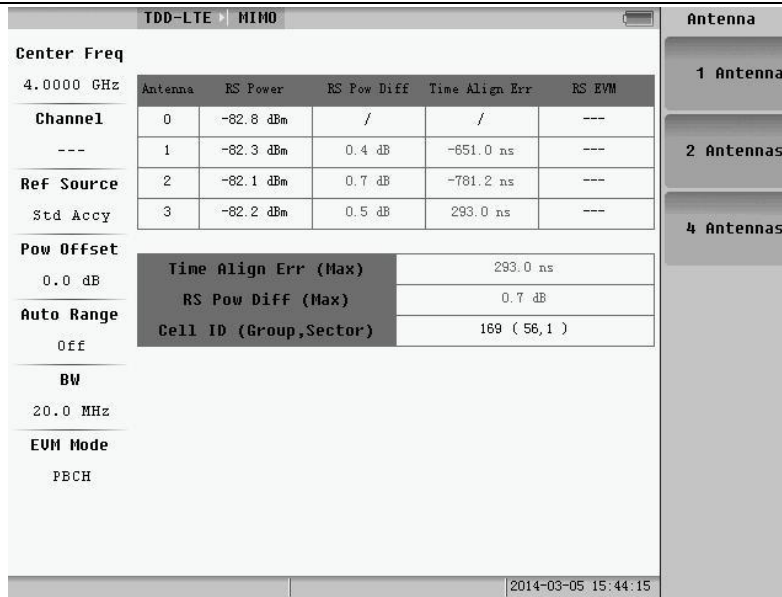

Fig.5.38 Antenna submenu

Thres: press the submenu to set the RS Pow Diff and Time Align.

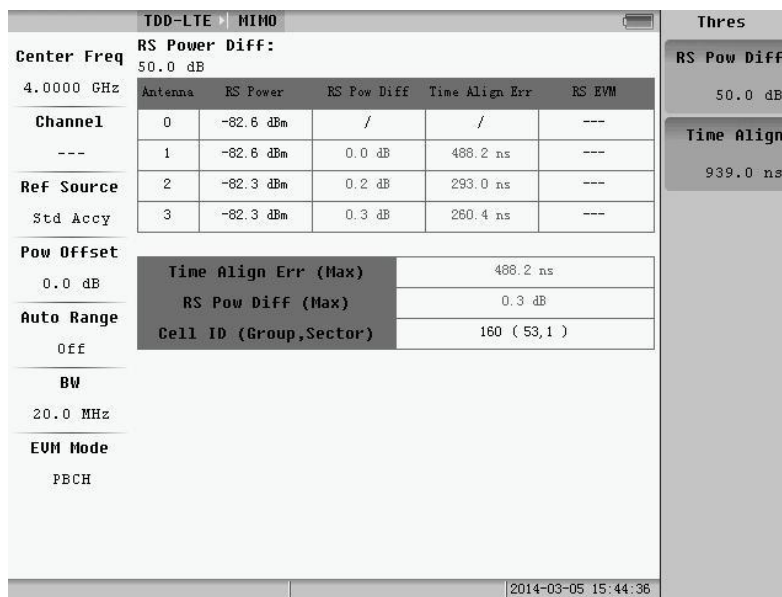

Fig.5.38 Thres submenu

Press the **FREQ AMPTD** function keys to set frequency and amplitude separately.

5.2 FDD-LTE

Select FDD-LTE soft-key to enter FDD-LTE menu, shown as the following pictures.

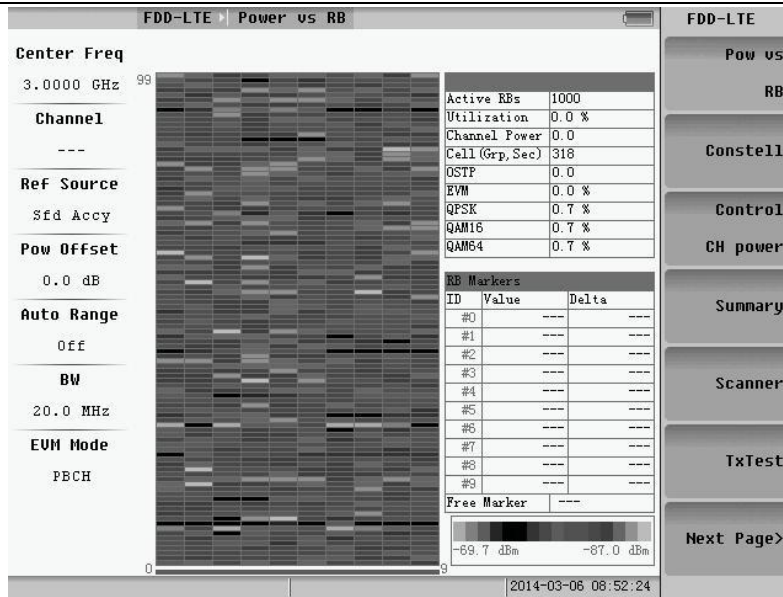

Fig.5.40 FDD-LTE menu (page 1)

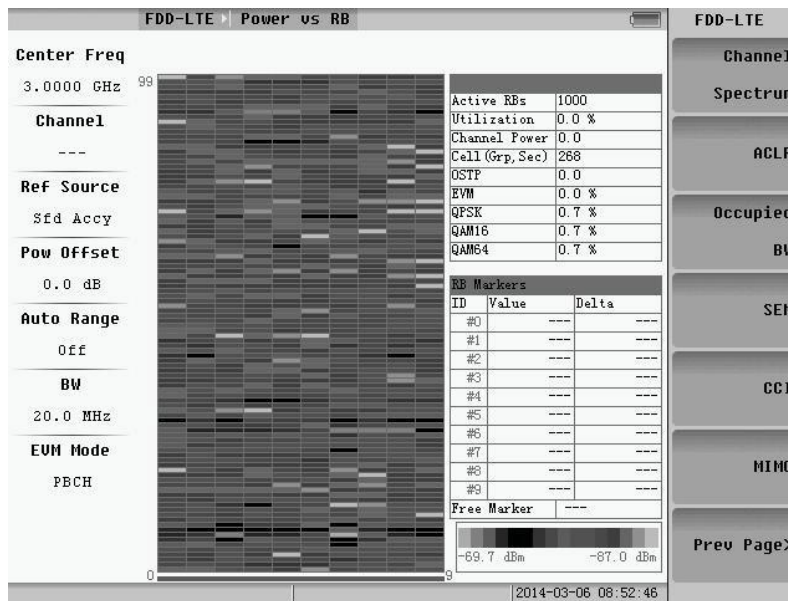

Fig.5.41 FDD-LTE menu (page 2)

5.2.1 Power vs. Resource block

Press the Pow vs. RB soft key to enter into the menu of Pow vs. RB, showing as the following figure:

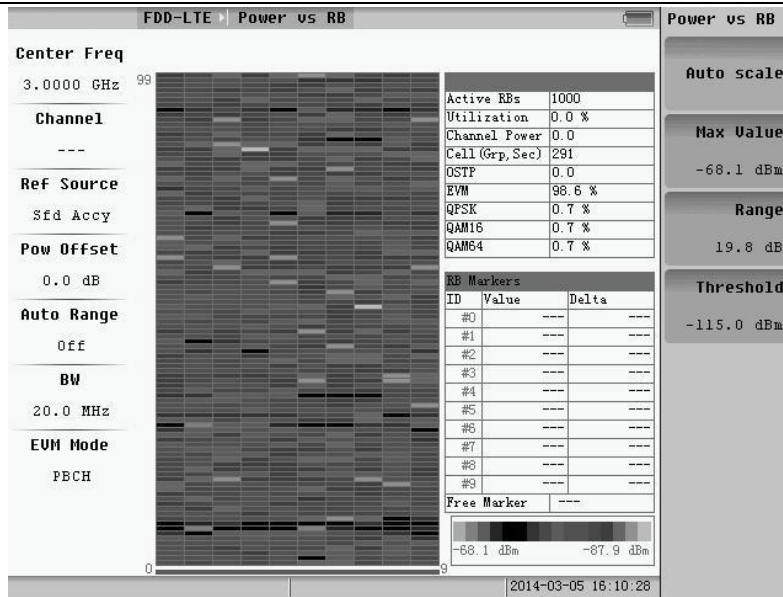

Fig.5.42 Pow vs. RB menu

1) Auto scale

Select the "Auto scale" to get RB power color images automatically.

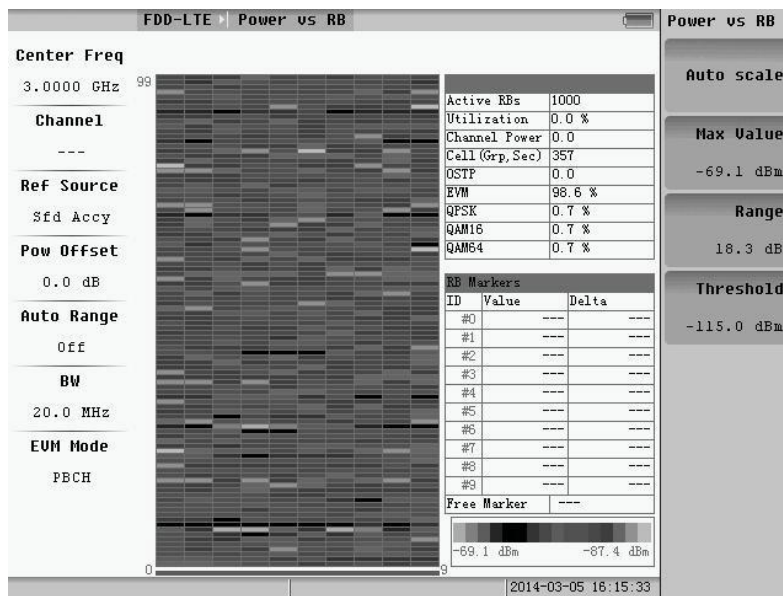

Fig.5.43 Auto scale

2) Max value, Range and Threshold

Choose the "Max Value", "Range" or "Threshold" to set the power of the RB the parameters of the color.

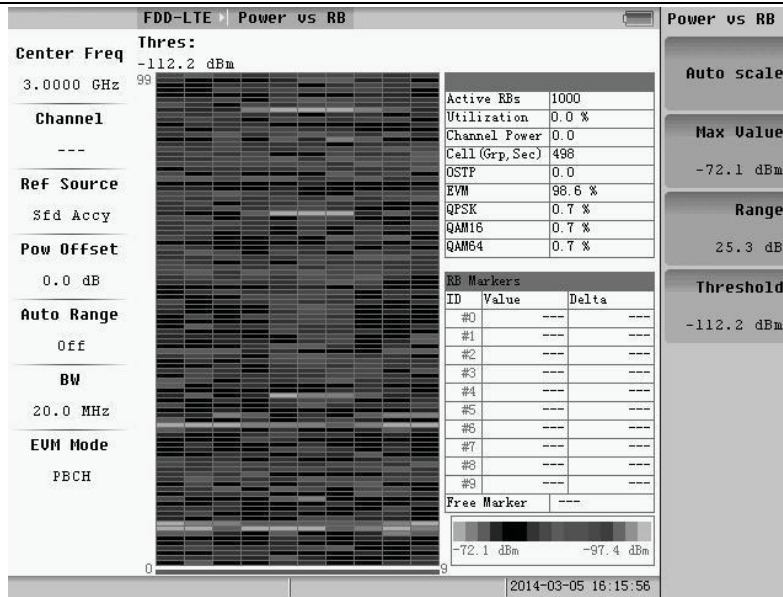

Fig.5.44 Set RB manually

- 3) Press the **FREQ AMPTD** function keys to set frequency and amplitude separately.
- 4) Press the **MARK** key to mark the Resource Block and Subframe.

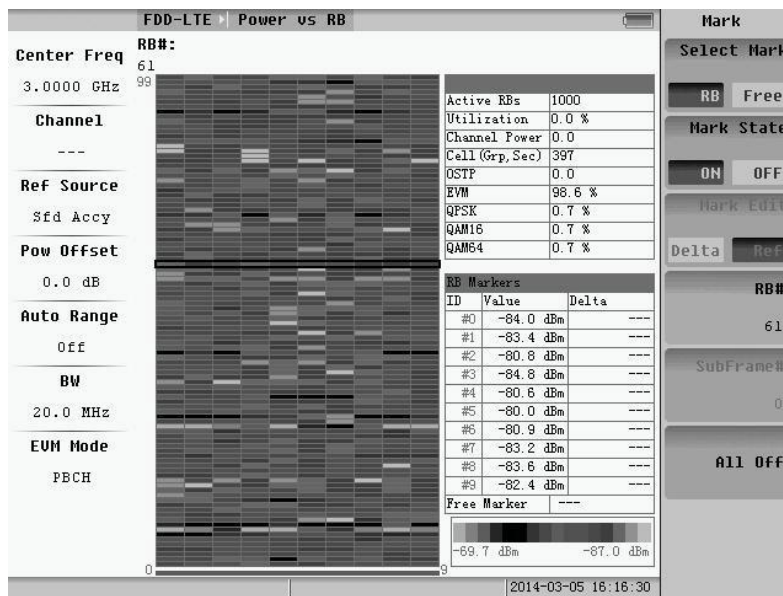

Fig.5.45 Mark the RB

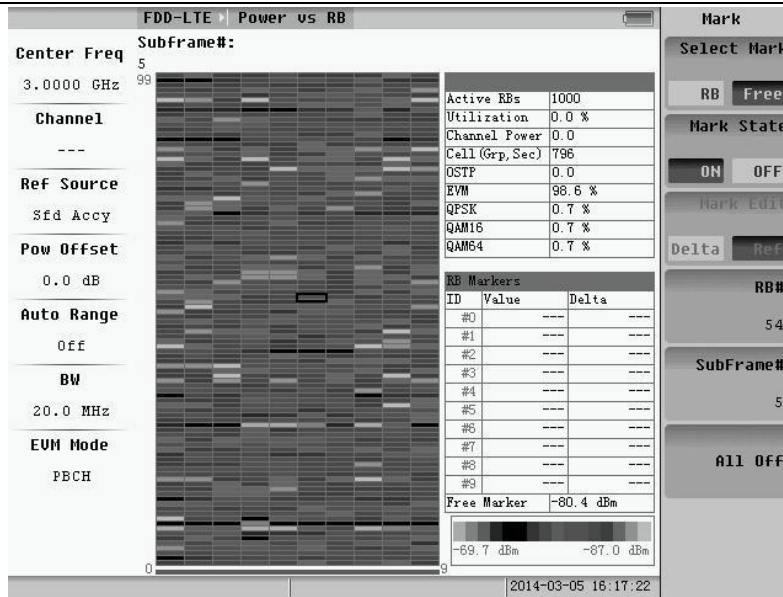

Fig.5.46 Mark the subframe

- 5) Press the **MEAS SETUP** key to set the basic parameter. Choose the bandwidth, open or close the EVM Max Hold, select the EVM Mode and open or close every channel.

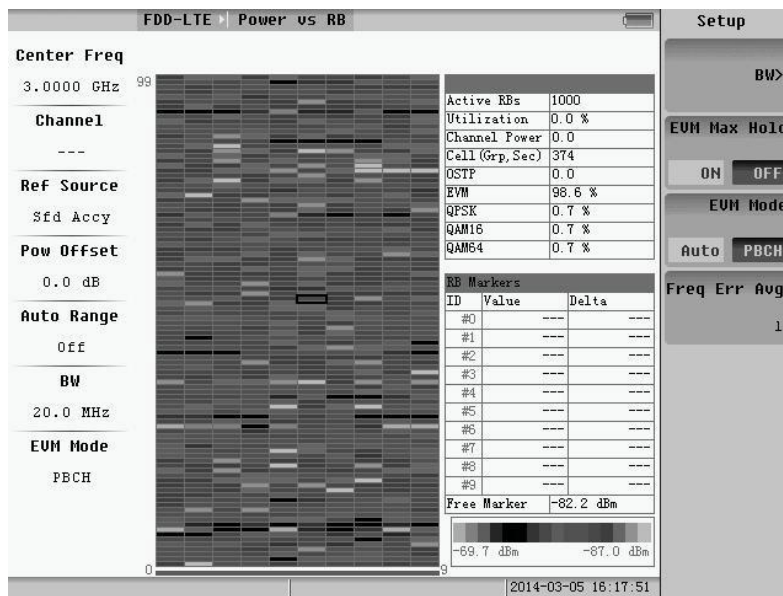

Fig.5.47 Setup

- 6) Press the **PEAK** key to peak search and find the Subframe of the Free Maker's max value.

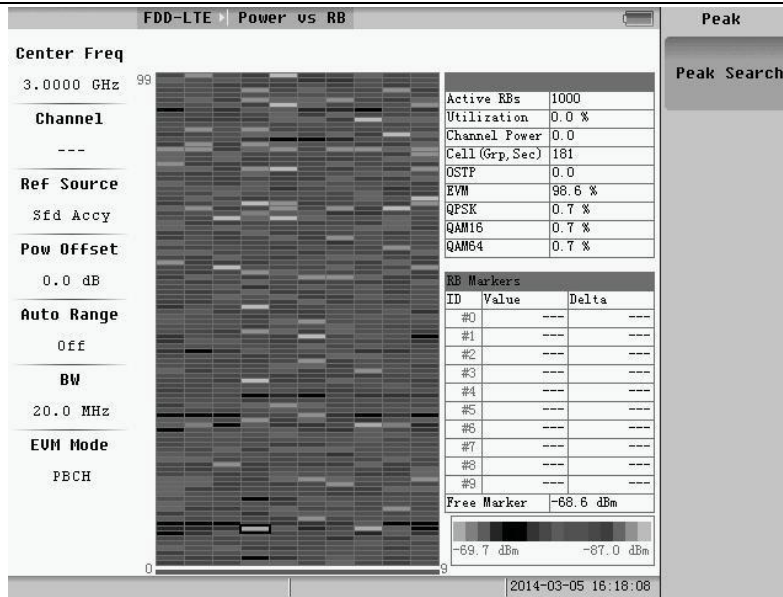

Fig.5.48 Peak search

5.2.2 Constellation

Select "Constell" to enter the menu, showing as the following figure:

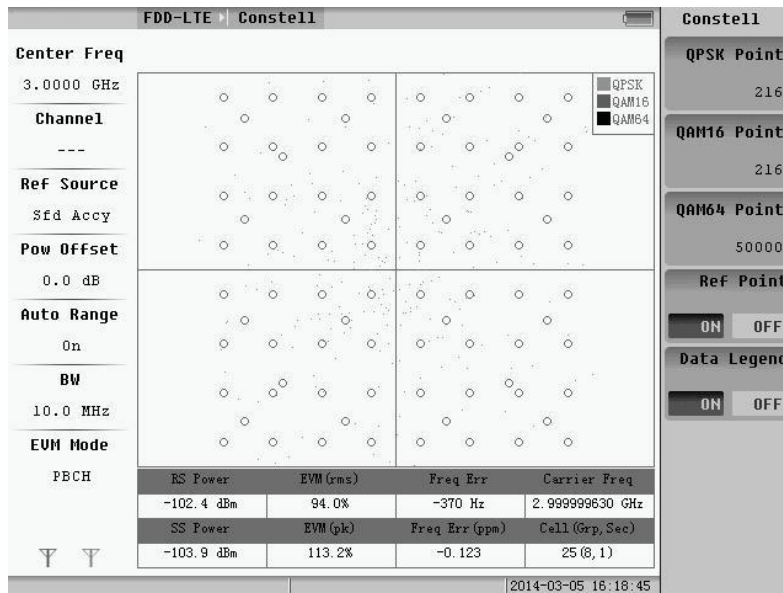

Fig.5.49 Constellation menu

- 1) QPSK points, QAM16 Point and QAM64 points

These buttons set the number of points.

- 2) Reference Point and Data Legend

Press the “Ref Point” key, and set the Reference Point open or off, the same as “Data Legend”.

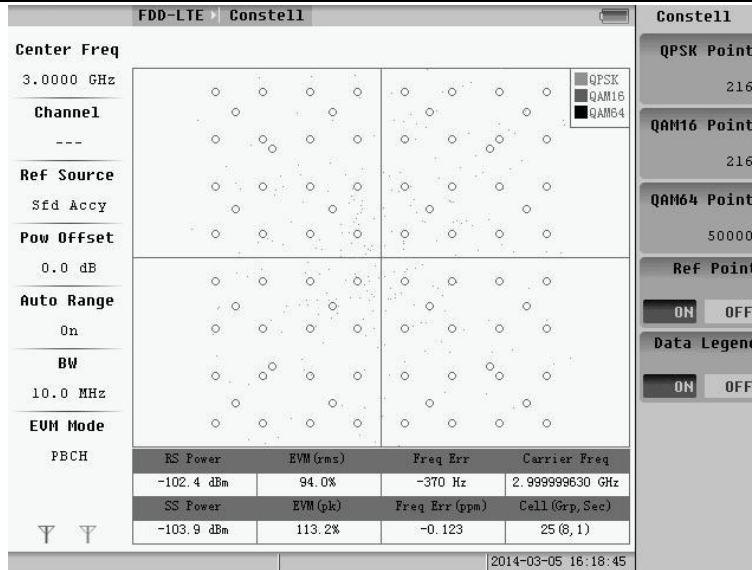

Fig.5.50 Reference point and data legend open

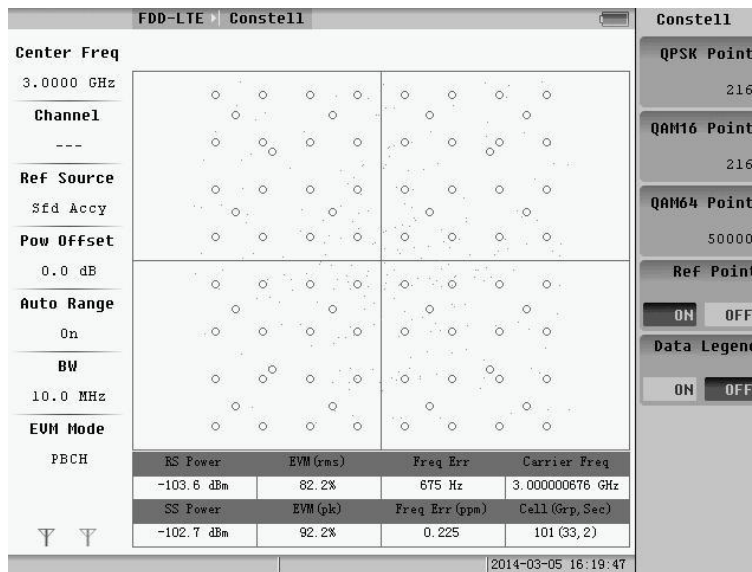

Fig.5.51 Reference point off

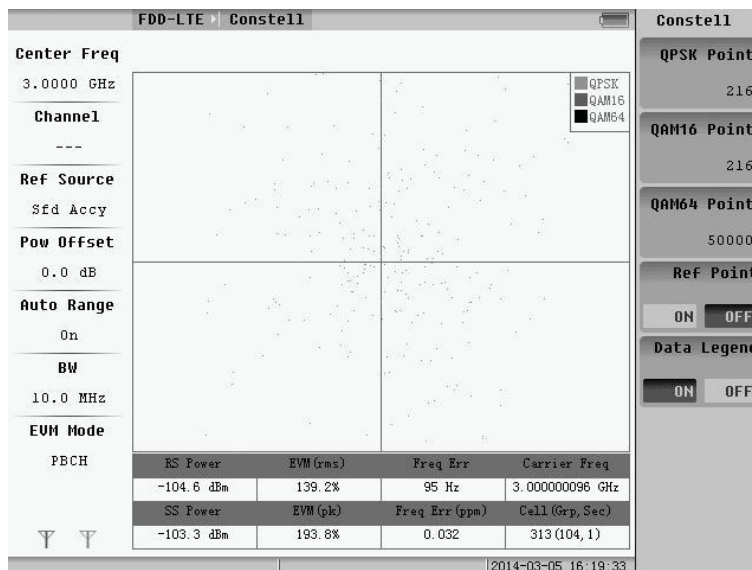

Fig.5.52 Data legend off

3) Press the **FREQ AMPTD MEAS SETUP** function keys to set frequency, amplitude and means separately.

5.2.3 Control channel power

Select the "Control CH Power" into the control channel power mode.

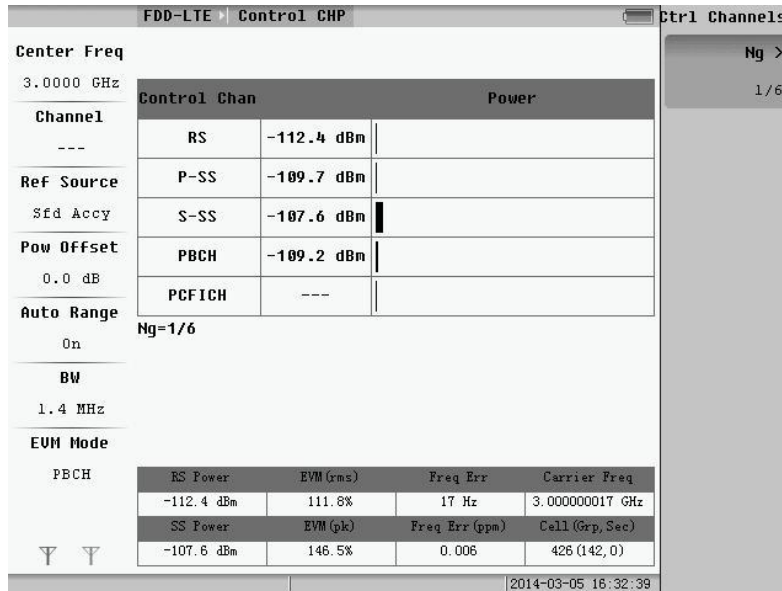

Fig.5.53 Control CH power measure

Ng: press into Ng submenu to choose Ng number.

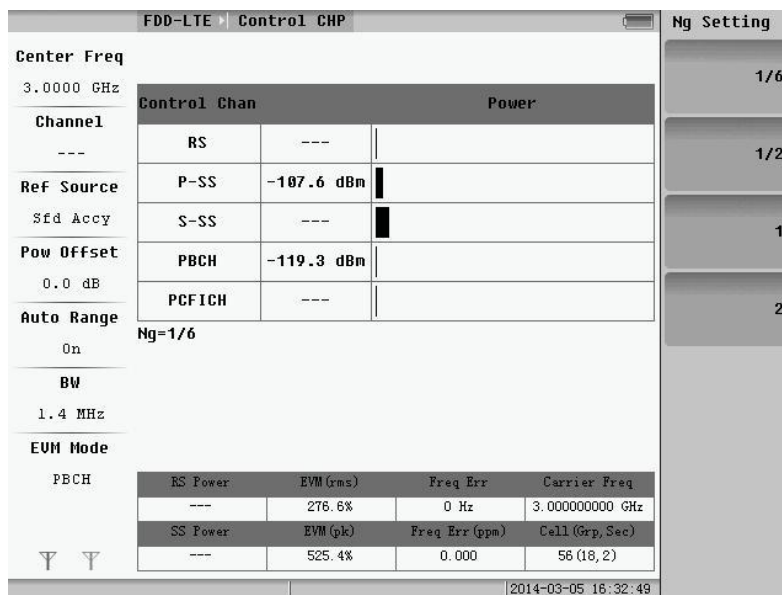

Fig.5.54 Ng submenu

Press the **FREQ AMPTD** function keys to set frequency and amplitude separately.

5.2.4 Summary

Select the "Summary" into the control channel power mode.

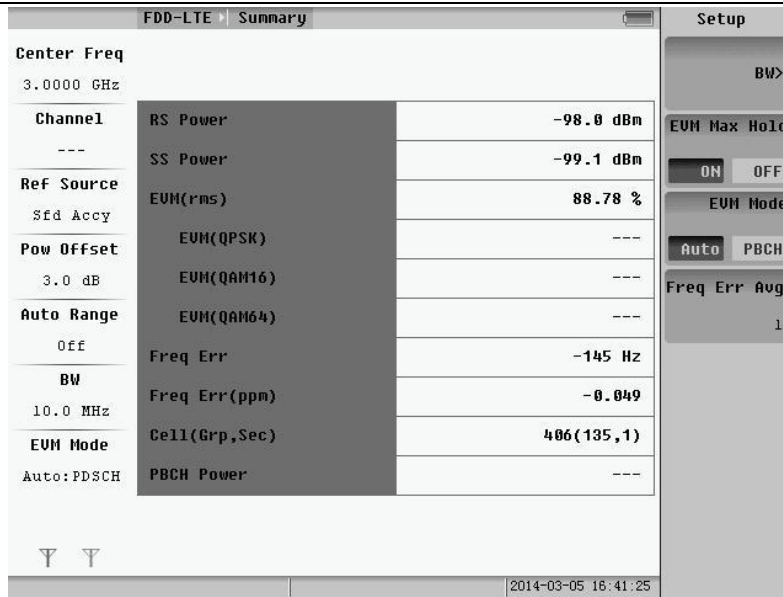

Fig.5.55 Summary measure

Press the **FREQ AMPTD** function keys to set frequency and amplitude separately.

5.2.5 OTA scanner

The menu is shown as following:

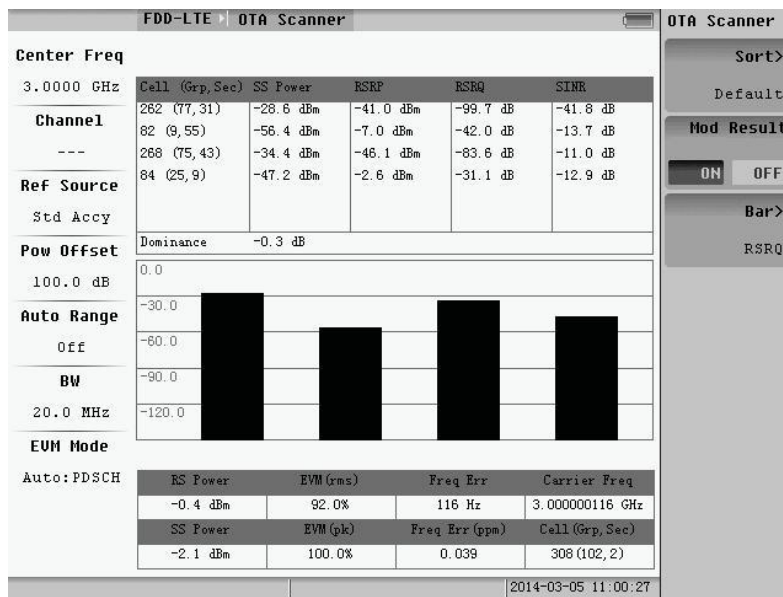

Fig.5.56 OTA scanner menu

1) Sort

Select the method and the selected numbers order by value.

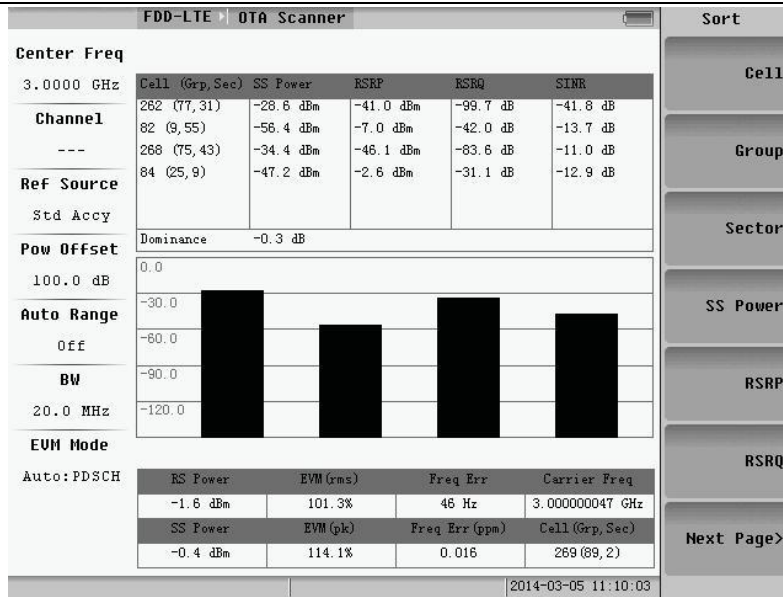

Fig.5.57 Selection of sort (page 1)

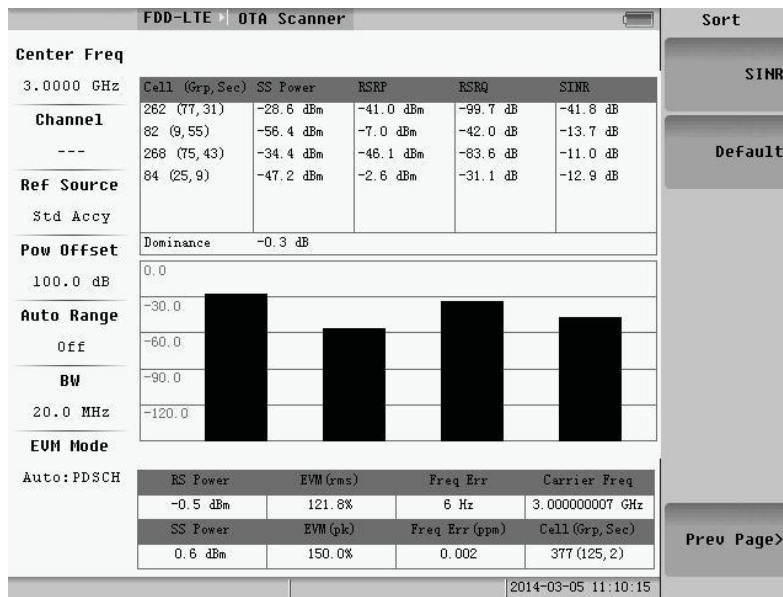

Fig.5.58 Selection of sort (page 2)

2) Modulation results

“Mod Result” can set the modulation results to open or close.

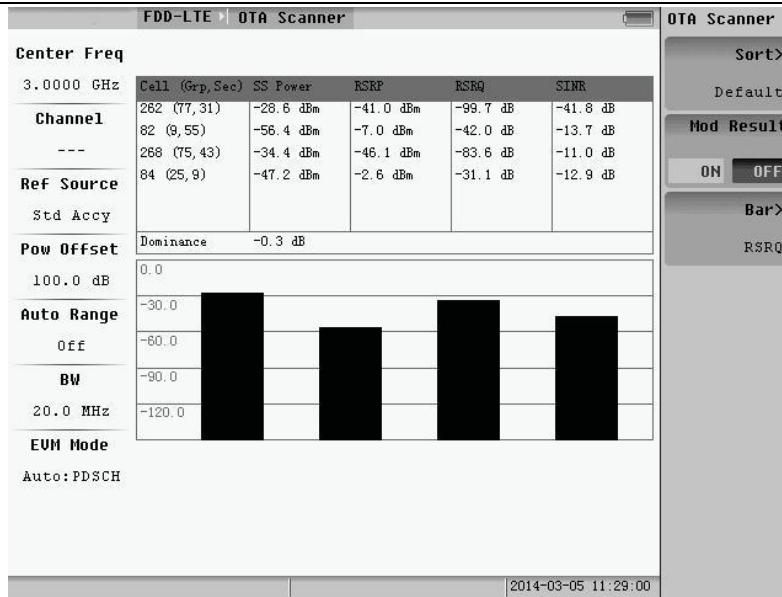

Fig.5.59 Mod Result close

3) Bar

Select "Bar >" to enter the submenu of bar, shown as Fig.5.60 .

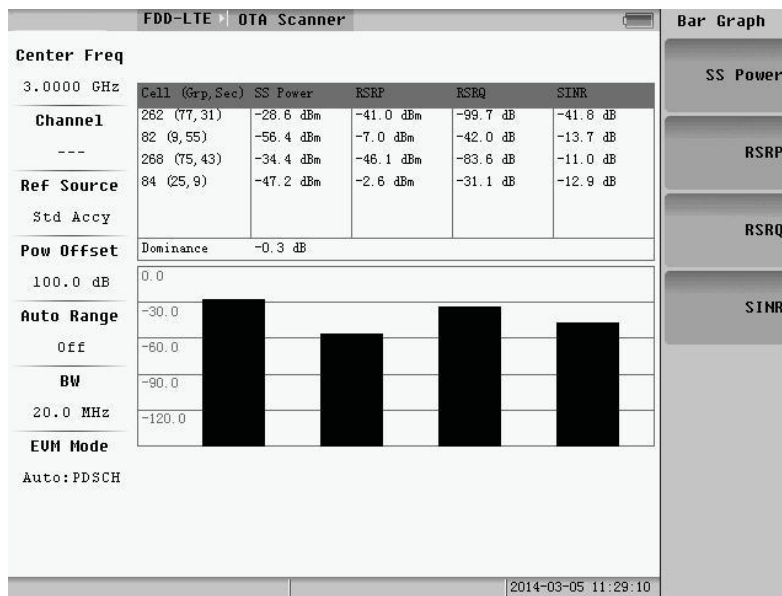

Fig.5.60 Selection of Bar

4) Pressing the **FREQ AMPTD MEAS SETUP** function keys can set frequency, amplitude and means separately.

5.2.6 Tx test

Tx Test measurements are optimized for remote radio heads and MIMO systems. The first table in Tx Test replicates the Scanner table measurements except the measurement scans the presence of up to 3 cell IDs. The second table shows the RS power across all detected antennas (transmitters) for the strongest Cell ID. This is displayed as average power and delta power for the detected transmitters, along with a small bar graph that shows the relative RS powers for each Tx. The PBCH Modulation Results table can also be turned on.

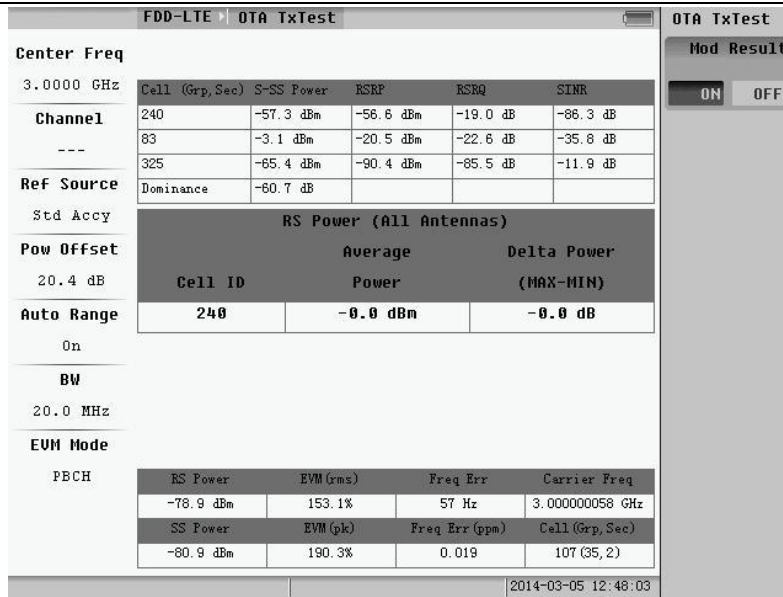

Fig.5.61 Tx test measure

"Mod Result" can set the modulation results to open or close.

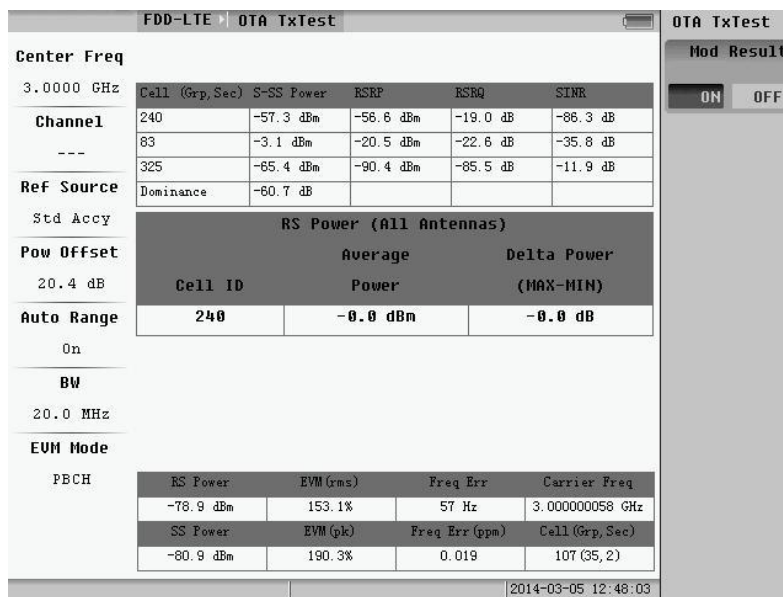

Fig.5.62 Mod result close

Press the **FREQ AMPTD** function keys c to set frequency and amplitude separately.

5.2.7 Channel power

Select the "channel spectrum" to enter the submenu.

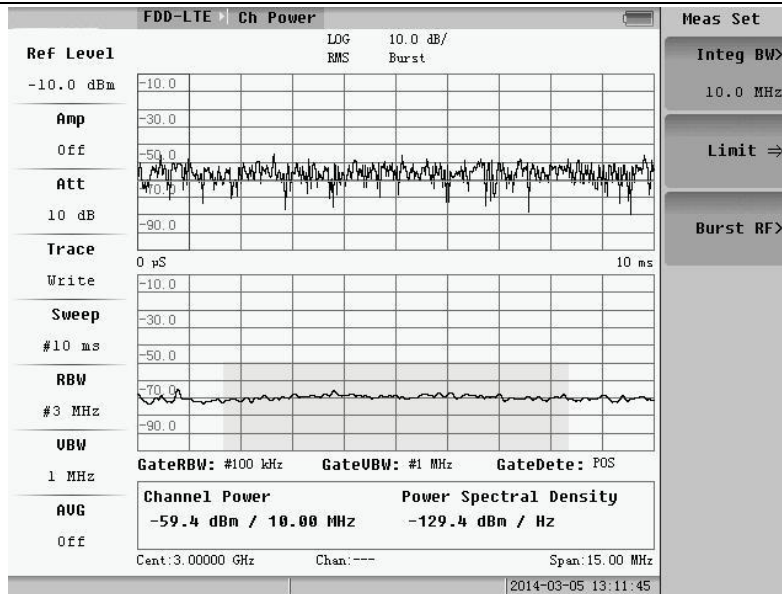

Fig.5.23 Channel power menu

The Channel Power in the mode of FDD-LTE is basically the same as that in Spectrum Analyzer.

5.2.8 ACLR

Select the “ACLR” to enter the submenu.

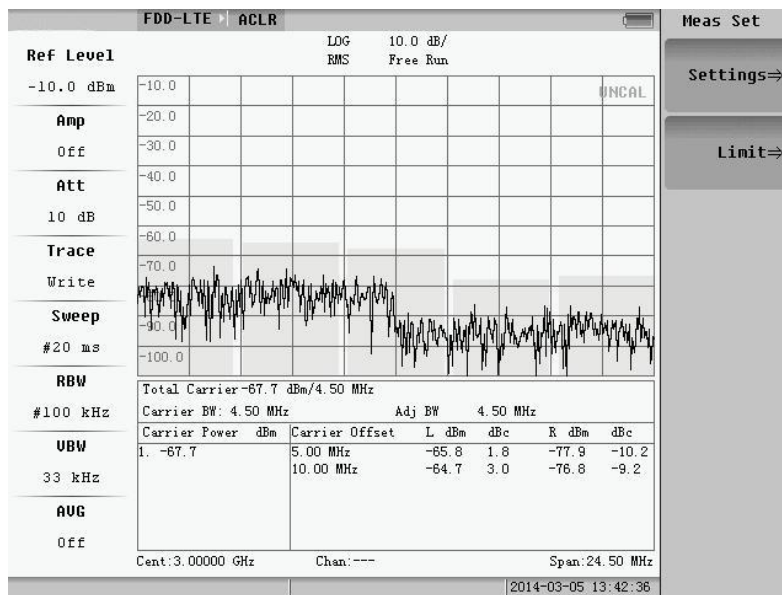

Fig.5.64 ACLR menu

Choose the “Setting=>” or ”Limit=>”, the window will pop up, and you can set parameter.

The ACLR in the mode of FDD-LTE is basically the same as that in Spectrum Analyzer.

5.2.9 Occupied bandwidth

Select the “Occupied BW” to enter the submenu.

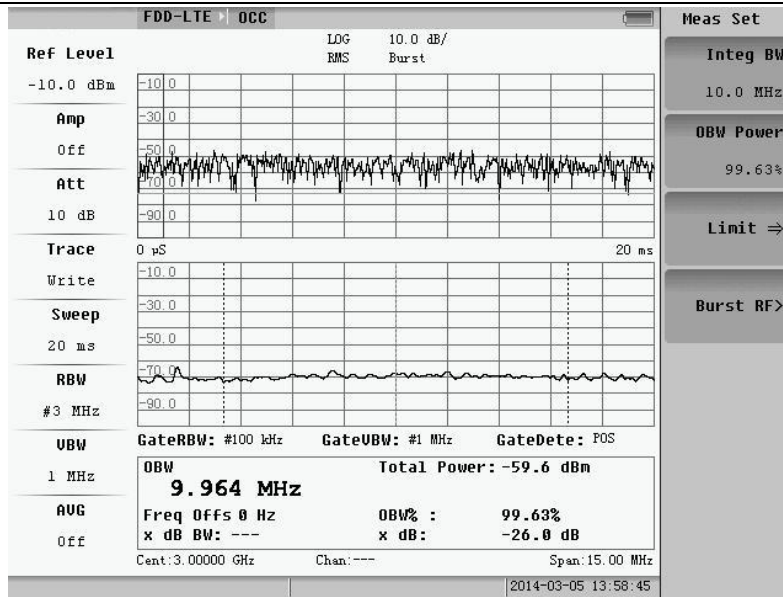

Fig.5.65 Occupied BW menu

The Occupied BW in the mode of FDD-LTE is basically the same as that in Spectrum Analyzer.

5.2.10 SEM

Select the “SEM” to enter the submenu.

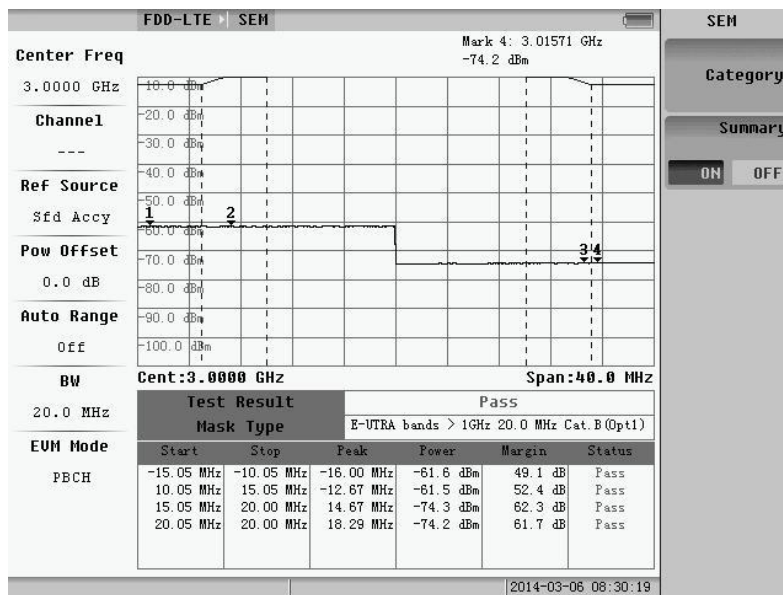

Fig.5.66 SEM menu

Category: press to enter the submenu of SEM Category.

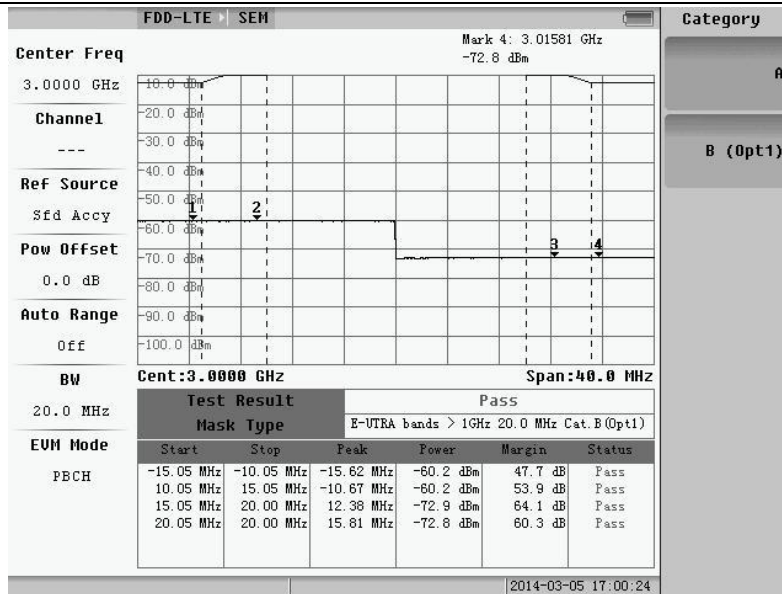

Fig.5.67 Submenu of category

Summary: press to open or close the summary.

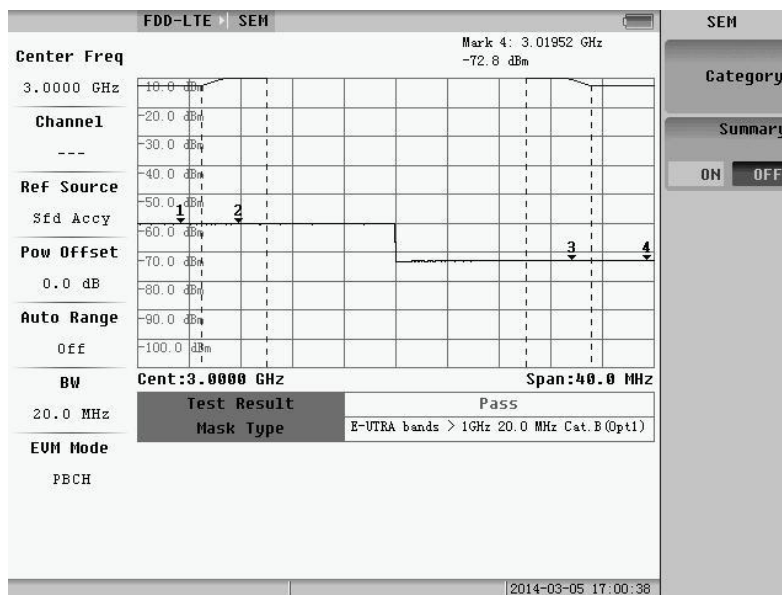

Fig.5.68 Summary closed

Press the **FREQ AMPTD CPL** function keys to set frequency, amplitude and other basic settings separately.

5.2.11 CCI

Select the “CCI” to enter the submenu.

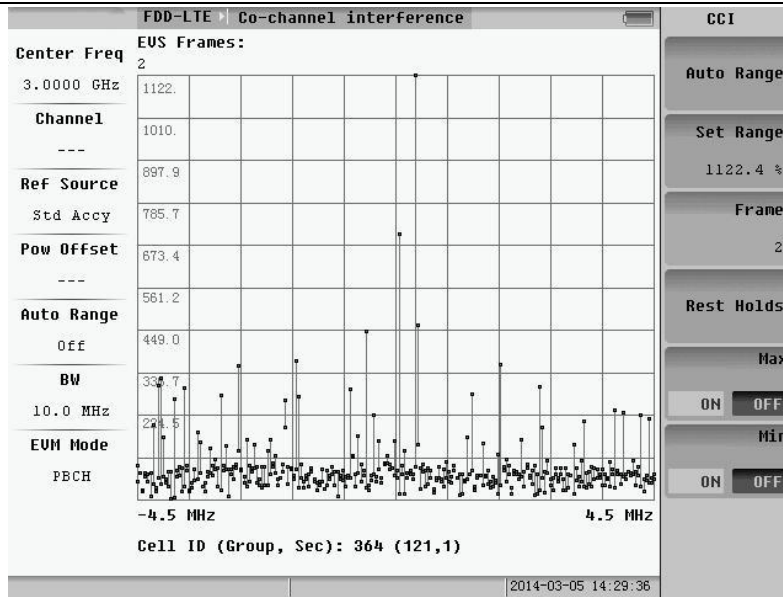

Fig.5.69 CCI menu

Frame: change the value of Frame, which is 1 or 2.

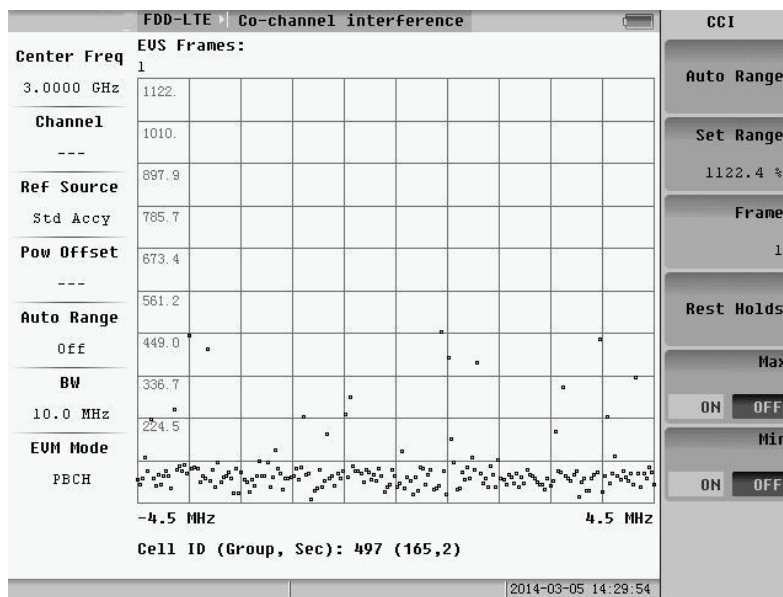

Fig.5.70 One frame

Max: Press to open or close max holds.

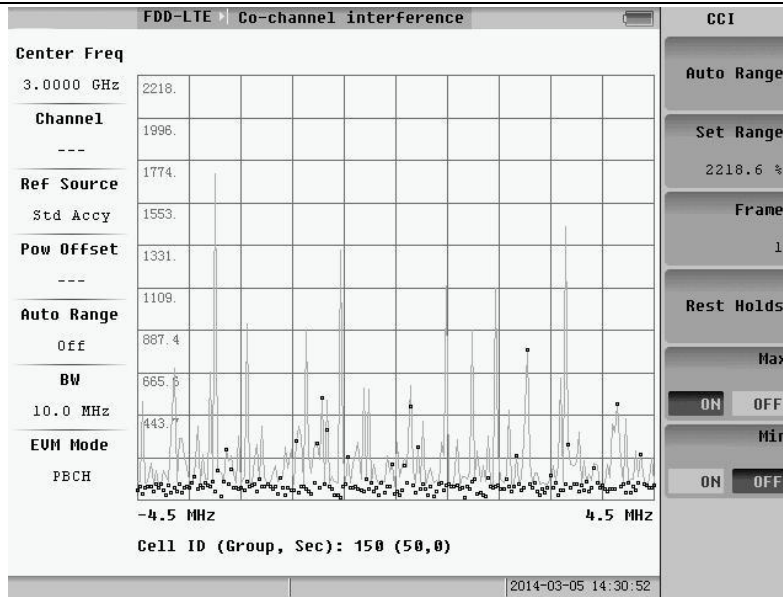

Fig.5.71 Max holds

Min: Press to open or close min holds.

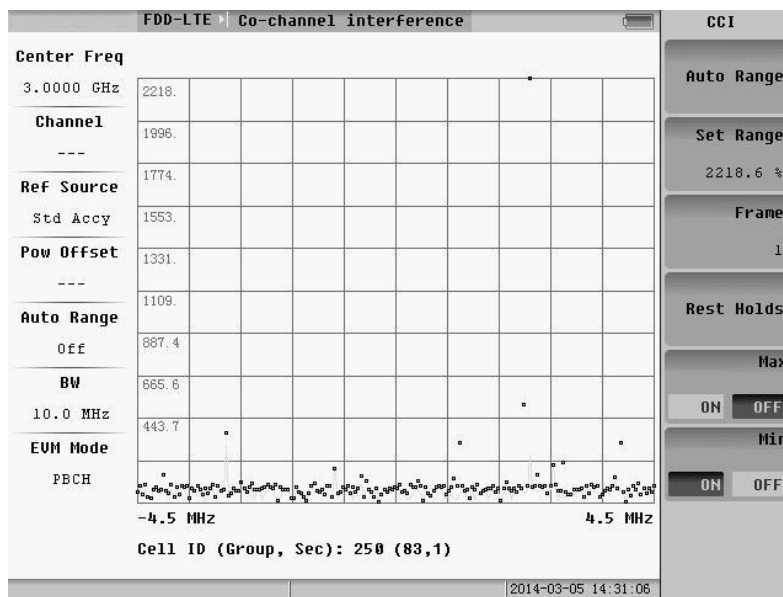

Fig.5.72 Min holds

Rest Holds: Remove max and min holds, and then hold again.

Press the **FREQ AMPTD MARK** function keys to set frequency, amplitude and mark separately.

5.2.12 MIMO

Select the “MIMO” to enter the submenu.

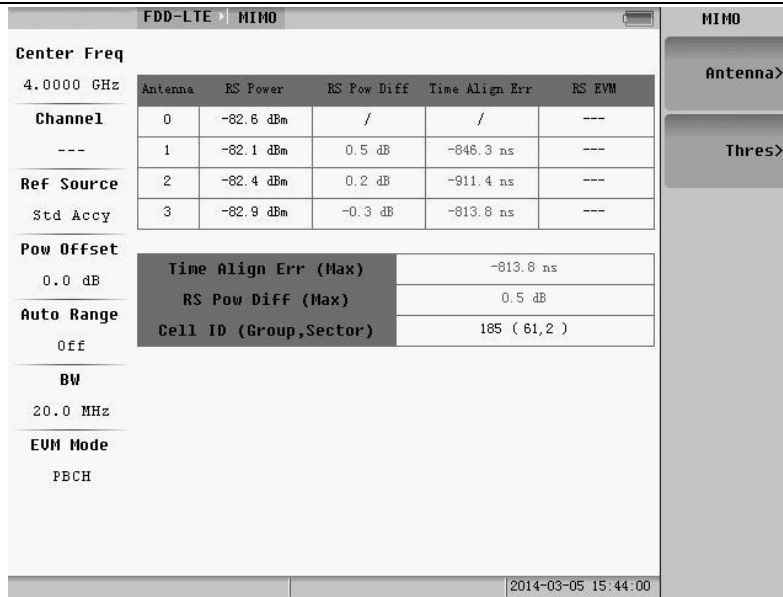

FDD-LTE | MIMO

Center Freq
4.0000 GHz

Antenna	RS Power	RS Pow Diff	Time Align Err	RS EVM
0	-82.8 dBm	/	/	---
1	-82.1 dBm	0.5 dB	-846.3 ns	---
2	-82.4 dBm	0.2 dB	-911.4 ns	---
3	-82.9 dBm	-0.3 dB	-813.8 ns	---

Channel: ---

Ref Source: 2

Std Accy: 3

Pow Offset: 0.0 dB

Time Align Err (Max)	-813.8 ns
RS Pow Diff (Max)	0.5 dB
Cell ID (Group,Sector)	185 (61,2)

Auto Range: Off

BW: 20.0 MHz

EVM Mode: PECH

2014-03-05 15:44:00

Fig.5.73 MIMO menu

Antenna: press into the submenu to select antenna number.

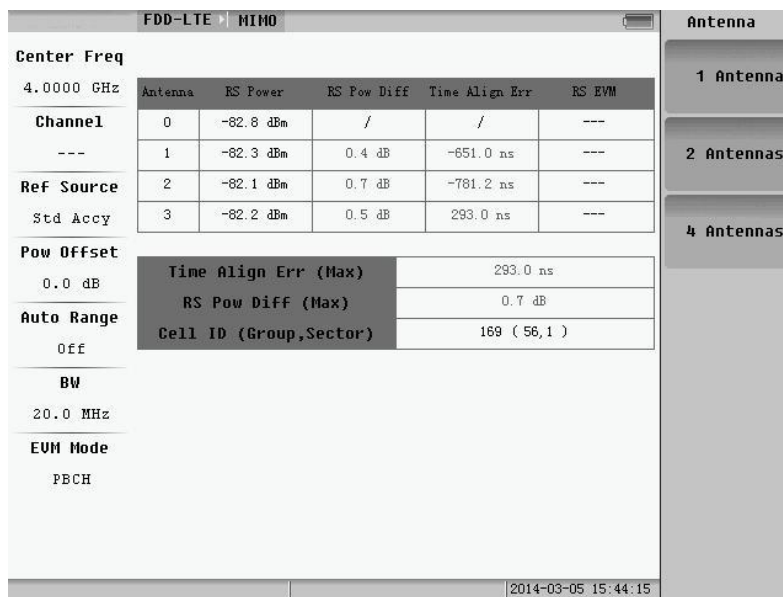

FDD-LTE | MIMO

Center Freq
4.0000 GHz

Antenna	RS Power	RS Pow Diff	Time Align Err	RS EVM
0	-82.8 dBm	/	/	---
1	-82.3 dBm	0.4 dB	-651.0 ns	---
2	-82.1 dBm	0.7 dB	-781.2 ns	---
3	-82.2 dBm	0.5 dB	293.0 ns	---

Channel: ---

Ref Source: 2

Std Accy: 3

Pow Offset: 0.0 dB

Time Align Err (Max)	293.0 ns
RS Pow Diff (Max)	0.7 dB
Cell ID (Group,Sector)	169 (56,1)

Auto Range: Off

BW: 20.0 MHz

EVM Mode: PECH

2014-03-05 15:44:15

Fig.5.74 Antenna submenu

Thres: press into the submenu to set the RS Pow Diff and Time Align.

FDD-LTE		MIMO			
Center Freq	RS Power Diff: 50.0 dB				
4.0000 GHz	Antenna	RS Power	RS Pow Diff	Time Align Err	RS EVM
Channel	0	-82.6 dBm	/	/	---
---	1	-82.6 dBm	0.0 dB	488.2 ns	---
Ref Source	2	-82.3 dBm	0.2 dB	293.0 ns	---
Std Accy	3	-82.3 dBm	0.3 dB	260.4 ns	---
Pow Offset	Time Align Err (Max)		488.2 ns		
0.0 dB	RS Pow Diff (Max)		0.3 dB		
Auto Range	Cell ID (Group,Sector)		160 (53,1)		
Off					
BW	20.0 MHz				
EVM Mode	PECH				
2014-03-05 15:44:36					

Thres
RS Pow Diff
50.0 dB
Time Align
939.0 ns

Fig.5.75 Thres submenu

Press the **FREQ AMPTD** function keys to set frequency and amplitude separately.

Chapter 6 Coverage Mapping

Press the **MODE** button, select the Coverage Mapping of measurement mode, and then menu shown as Fig.6.1 will pop up.



Fig.76.1 Coverage mapping menu

6.1 SS Indoor

Select the “SS indoor” to enter the measure.

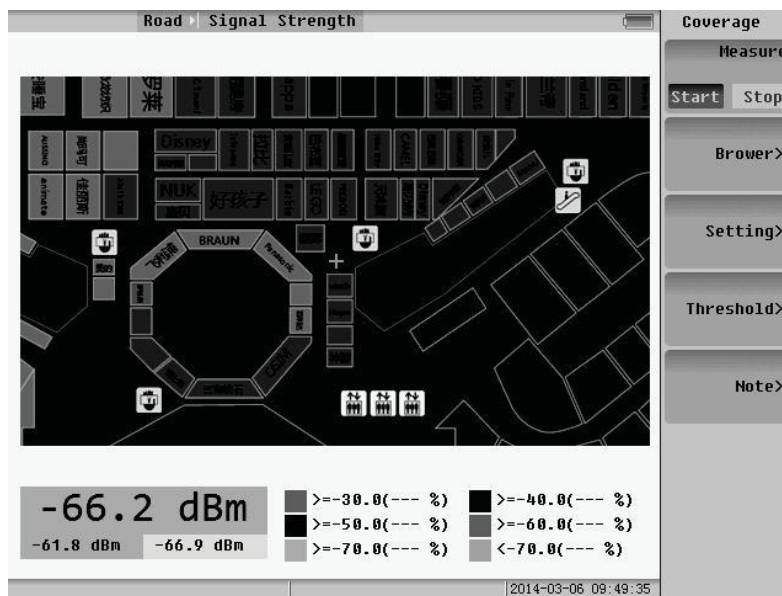

Fig.6.2 SS indoor menu

6.1.1 Measure setting

Measure: the status of the measure. Press to start or stop the measure.

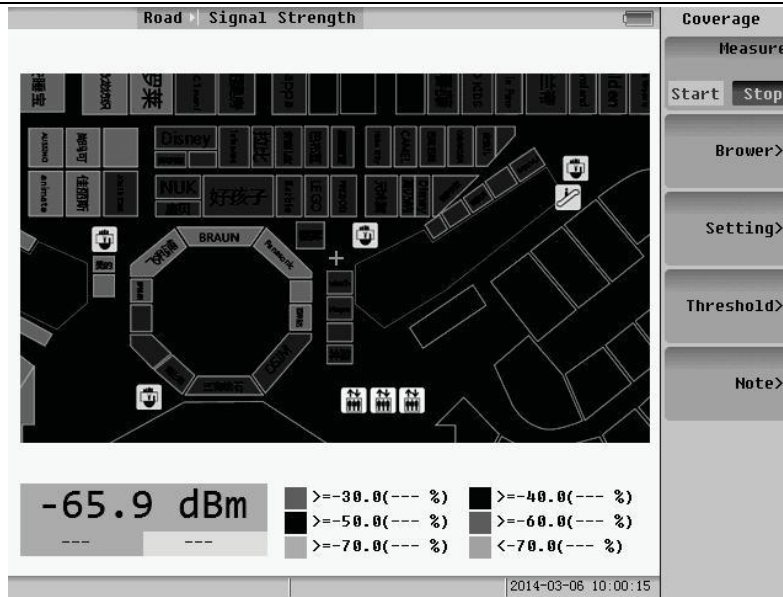

Fig.6.3 Measure stop

Brower: If it is bigger than the screen, the map can be move to the browse.

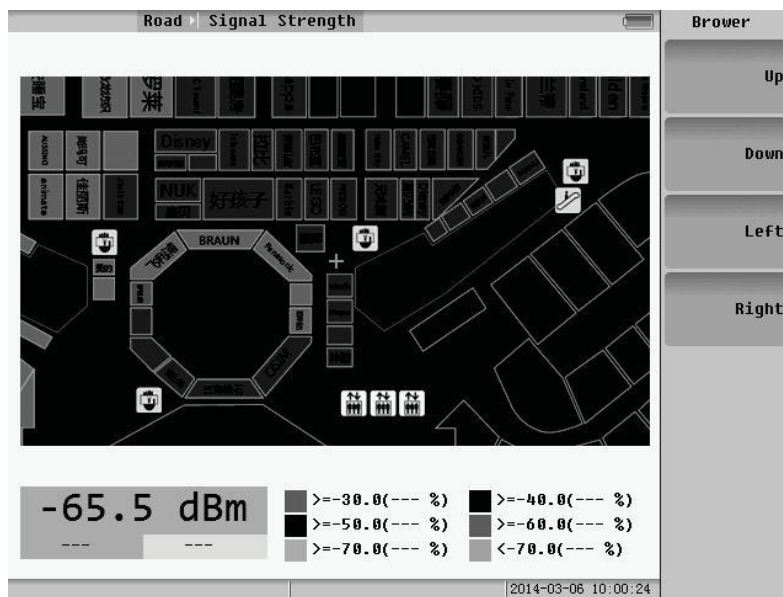

Fig.6.4 Brower operating menu

Setting: press to enter the setting menu. You can select time mode or free mode to measure. And if you choose time mode, the time interval can be set.

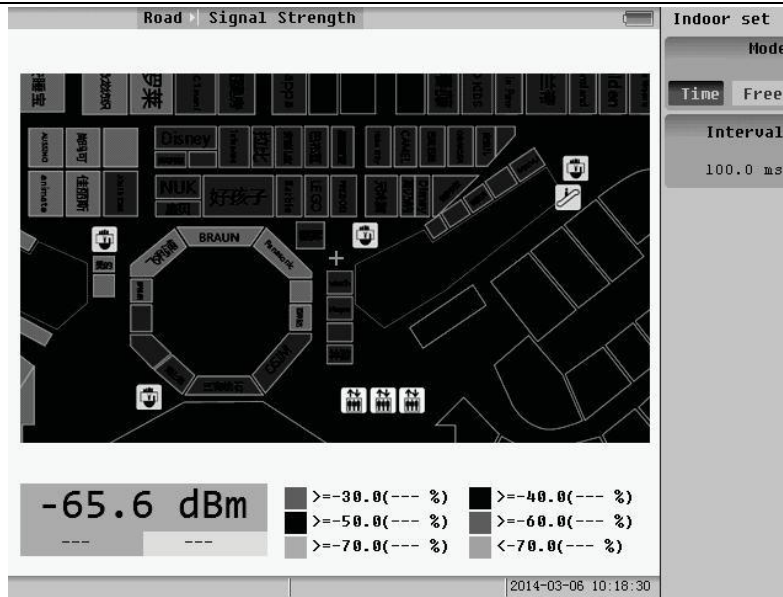

Fig.6.5 Setting menu

Threshold: press to enter the menu of threshold. You can choose the threshold needed.

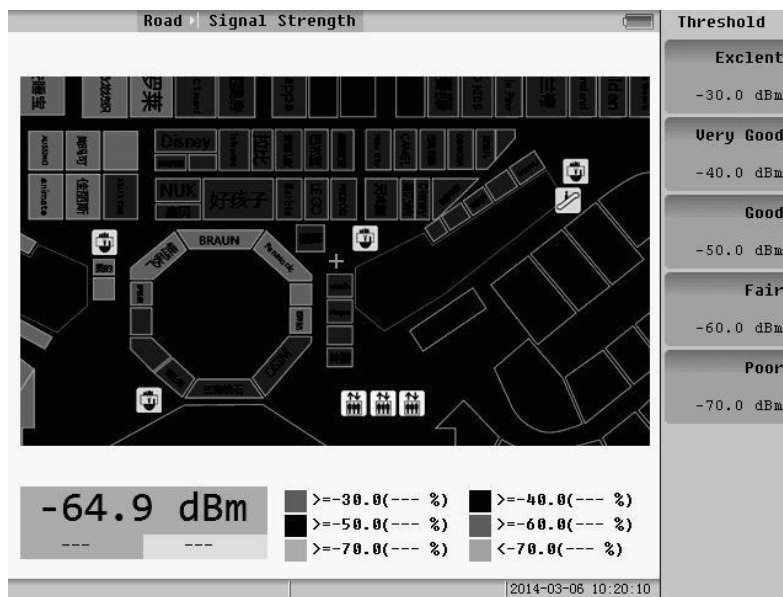

Fig.6.6 Threshold menu

NOTE: Press to enter the note menu, you can note the message of the measure.

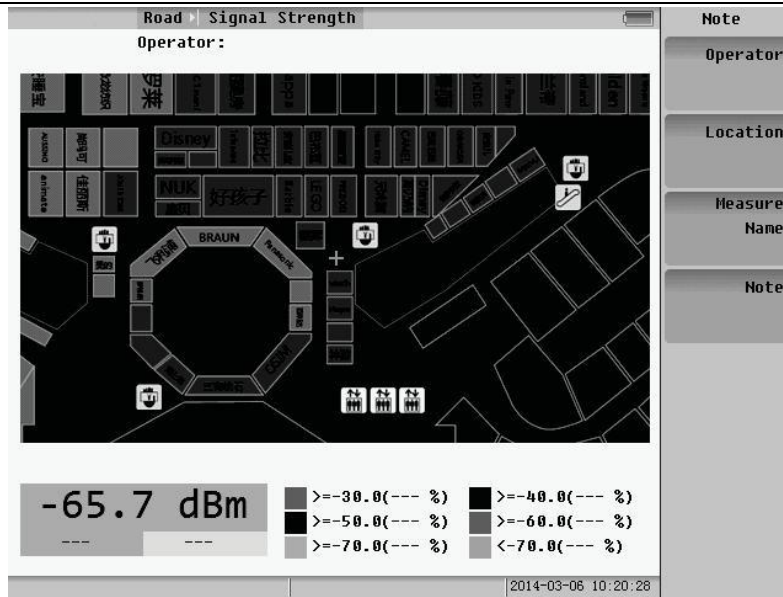

Fig.6.7 Note menu

6.1.2 Coverage measure

Indoor coverage measure has two types: time measure and free measure.

1. Time Measure

Press the **MARK** key to begin measuring. Insure that the measurement starts and the time interval is set.

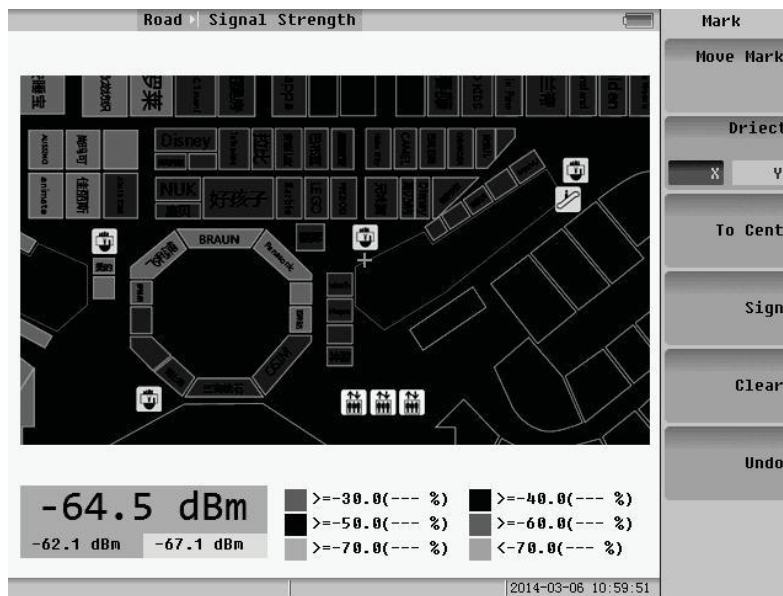

Fig.6.8 MARK menu

Move Mark: There is a mark in the screen; you can turn the Rotary Knob to move the mark.

Direct: Press to choose X axis or Y axis to be the moving direction. **To Cent :** press to make the mark return to the cent of the screen.

Sign: press to begin signing, and press again to finish signing. In this time, you can move the mark. When it finished signing, it signs points when you moving per a time interval.

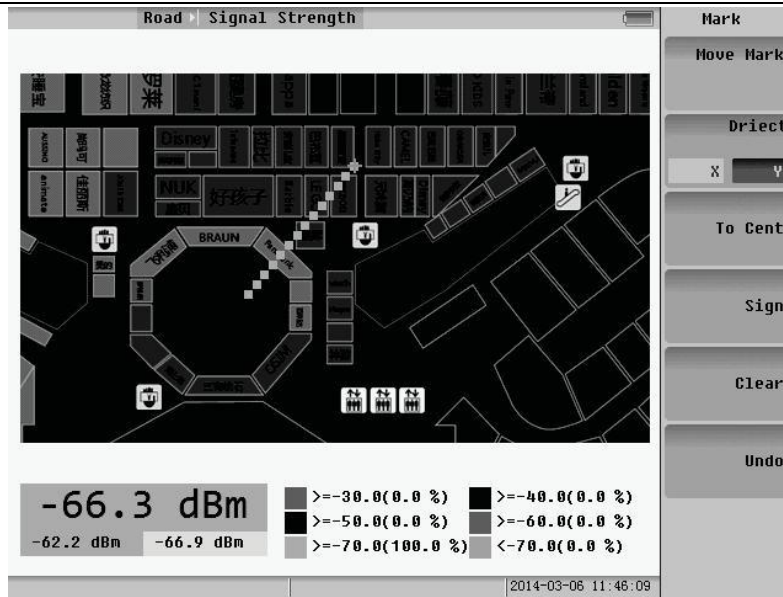

Fig.6.9 Sign (time interval is 1sec)

Clear: press to clear all the signed points.

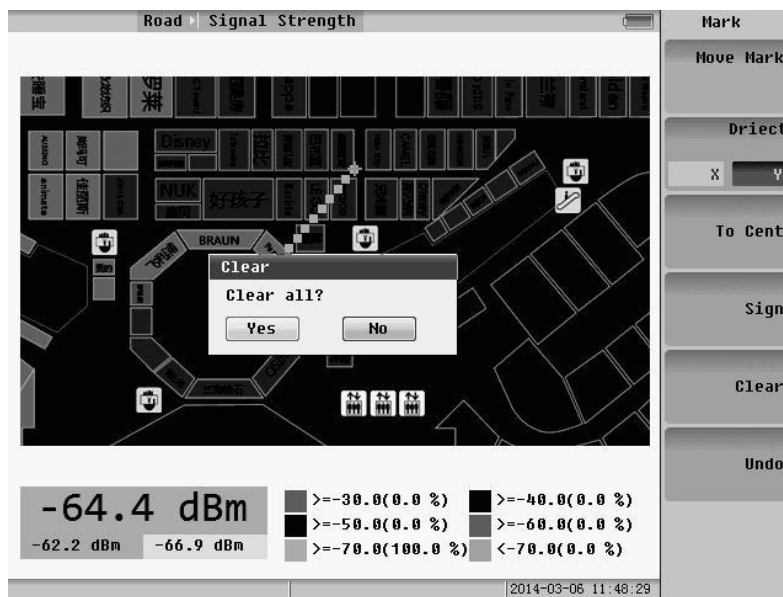

Fig.6.10 Clear all

Undo: press to clear the points last sign action.

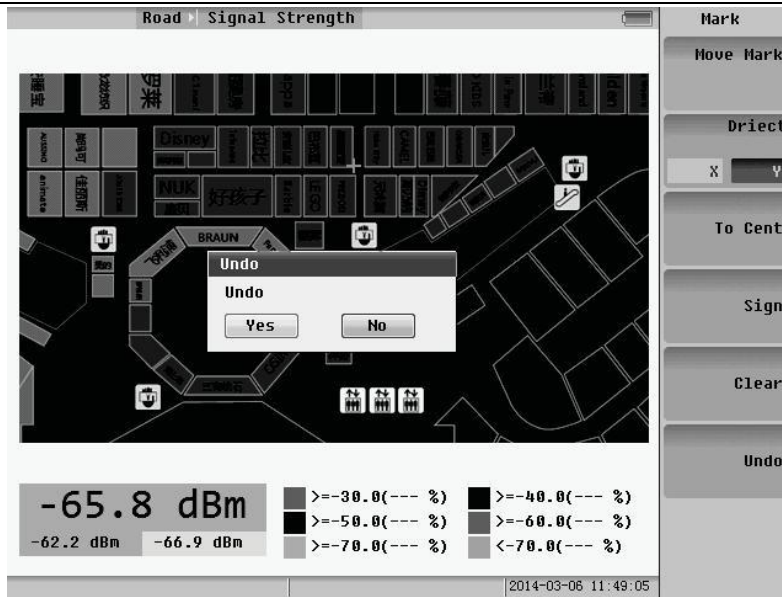

Fig.6.11 Undo

2. Free Measure

Sign: press to sign point where the mark is currently.

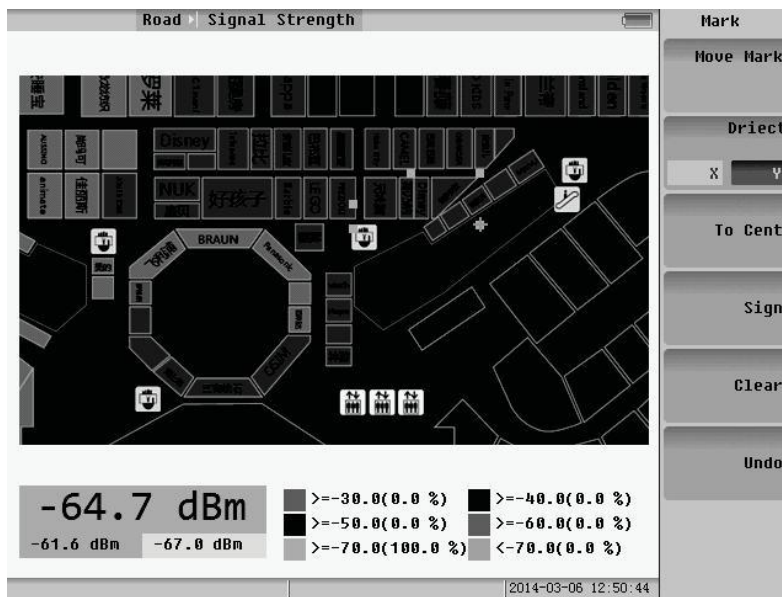

Fig.6.12 Sign free

Other operations are same as the step of Time Measure.

6.1.3 Save file of measure

Pressing the “Save” key, when the measure finished, the saving menu will pop up. And you should choose the “Meas Result >”.

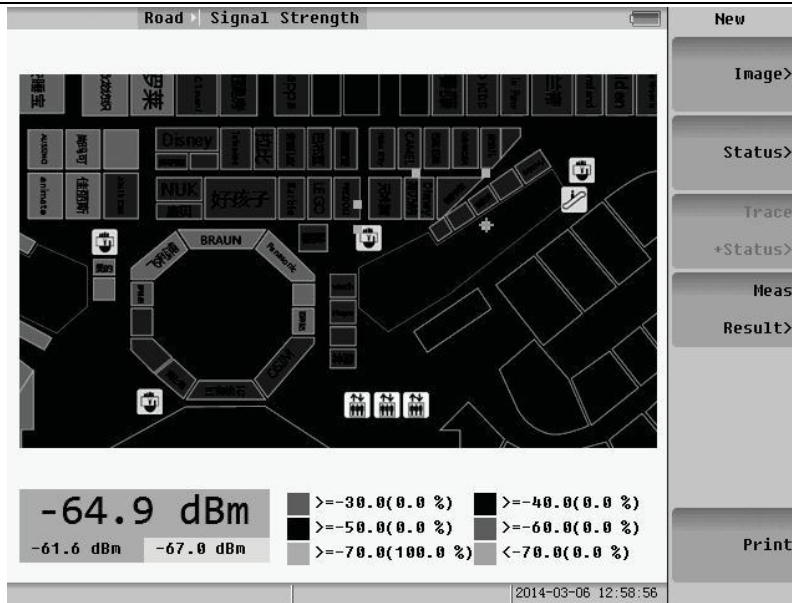

Fig.6.13 Save file menu

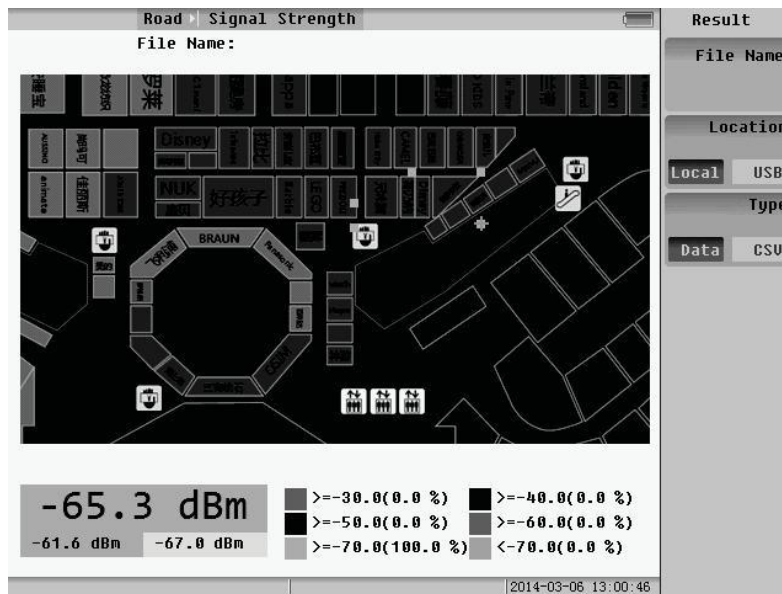

Fig.6.14 Save “Meas Result” menu

File Name: input file’s name.

Location: press to choose where the file is saved, location or USB.

Type: press to choose the file’s type.

6.1.4 Open file

When the Measure’s status stops, press the “SYS” key and the system menu will popup. Choose the “File Manager”, and the file menu will pop up.

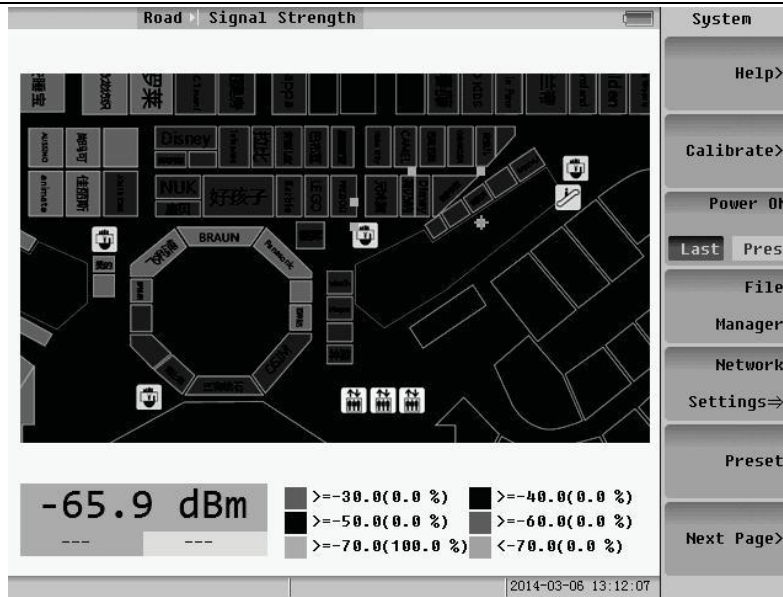

Fig.6.15 System menu

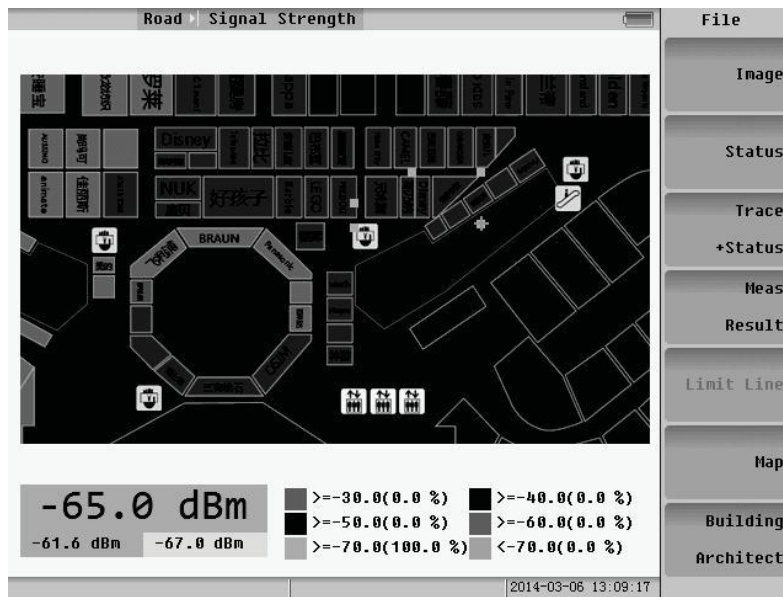

Fig.6.16 File manager menu

Choosing the “Meas Result” button and a window will pop up.

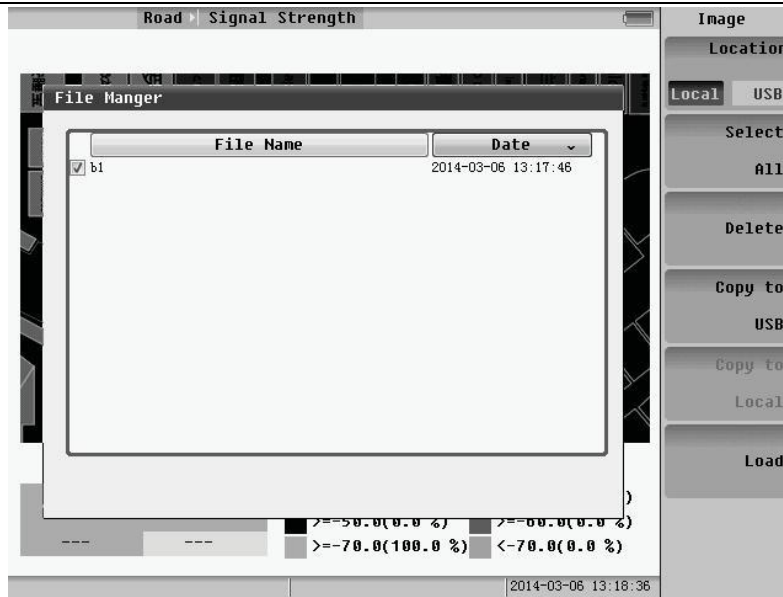

Fig.6.17 Measure file manager

6.2 SS Outdoor

Select the “SS outdoor” to enter the measurement menu.

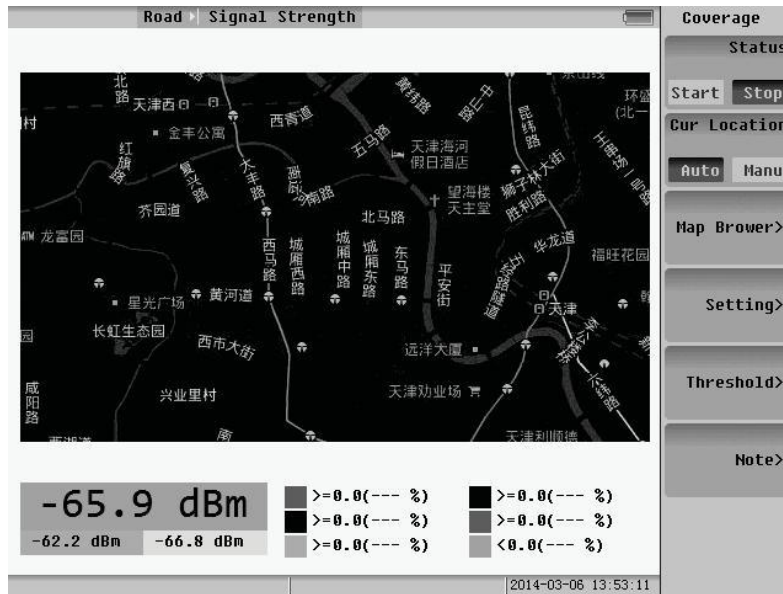

Fig.6.18 SS outdoor menu

6.2.1 Coverage measure

Status: press to start or stop measuring if the machine installs the GPS.

Cur Location: press to change the way by which getting the current position.

Map Brower: press to enter the menu of browsing map. You can zoom in, zoom out and move the map, and also change the type of the map that is planar map or satellite map.

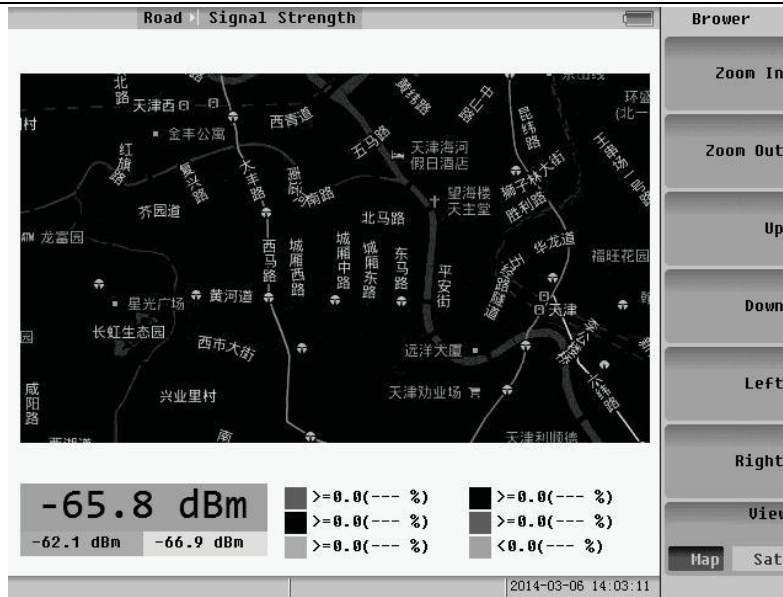

Fig.6.19 Map browser menu

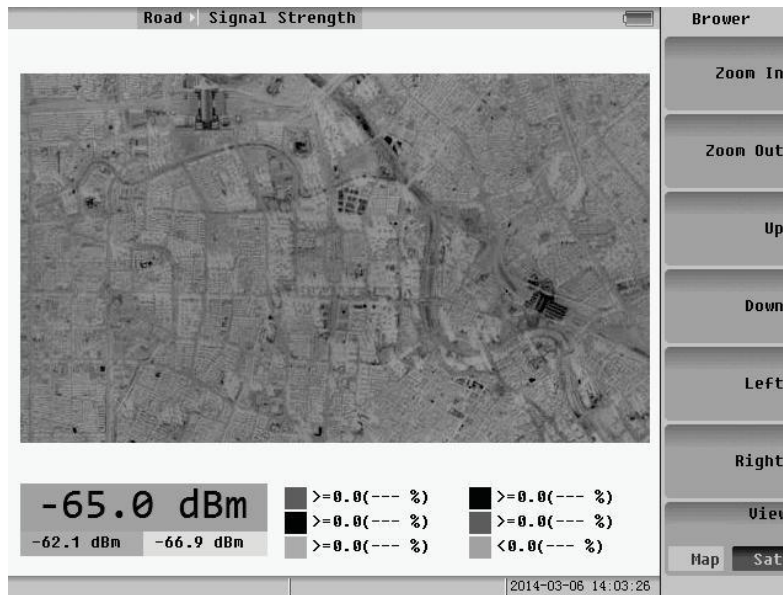

Fig.6.20 Satellite map

Setting: press to enter the setting menu. You can select time mode or distance mode to measure. And if you choose time mode, the time interval can be set.

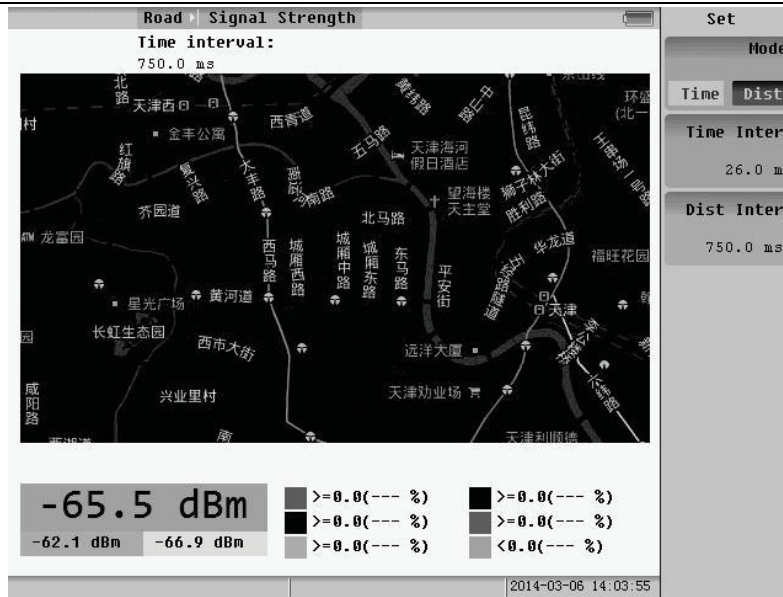

Fig.6.21 Setting menu

Threshold: same as the step of SS indoor.

NOTE: If the current location is auto, when you browse the map, the current location become manual.

6.2.2 Save file

Press the “Save” key. When the measure finished, the saving menu will pop up. And you should choose the “Meas Result >”.

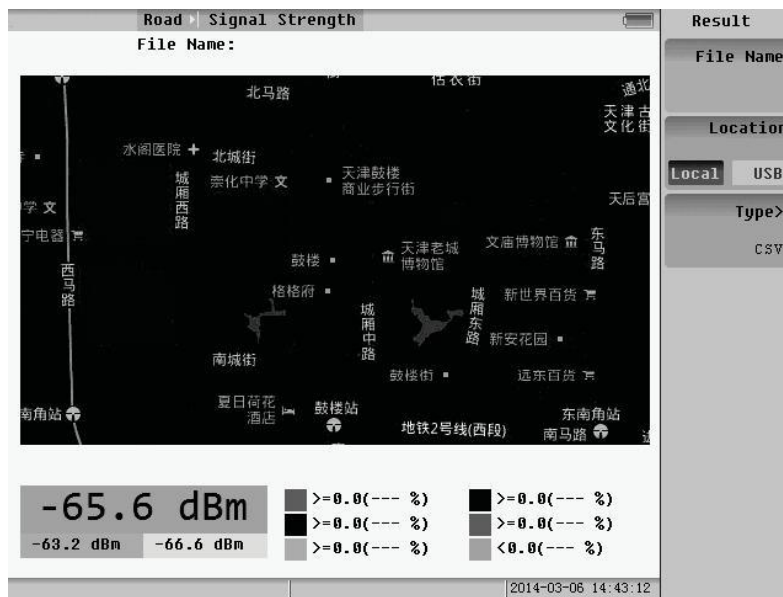

Fig.6.22 Save file menu

The file have three types:

- Data: it is used to replay.
- CSV: it is data list file.
- KML: it is used by Google Earth.



Fig.6.23 File type

Open File is same as the step of SS indoor.

Press the **FREQ AMPTD** function keys to set frequency and amplitude separately.

6.3 TDLTE Outdoor

Select the “TDLTE outdoor” to enter the measurement menu.

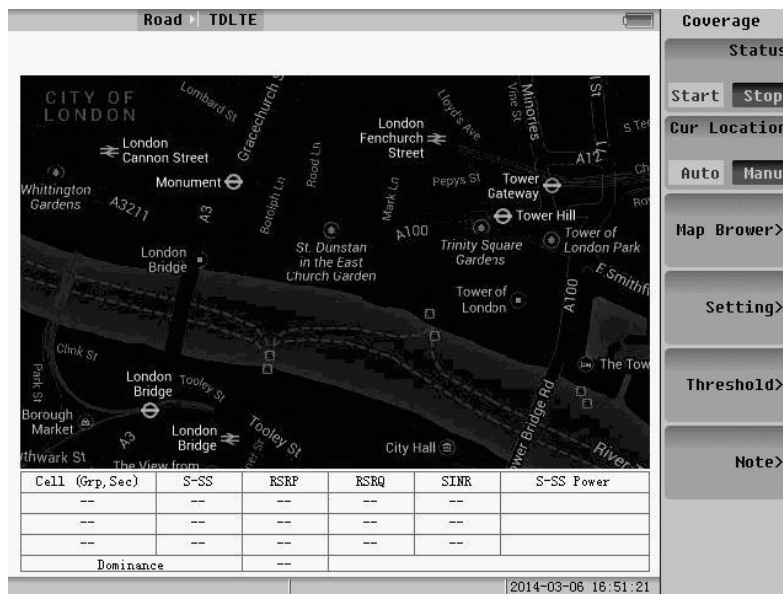

Fig.6.24 TDLTE outdoor menu

Setting: press to enter the setting menu. You can select time mode or distance mode to measure. And if you choose time mode, the time interval can be set. And press the key of Measurement to choose what you want to measure.

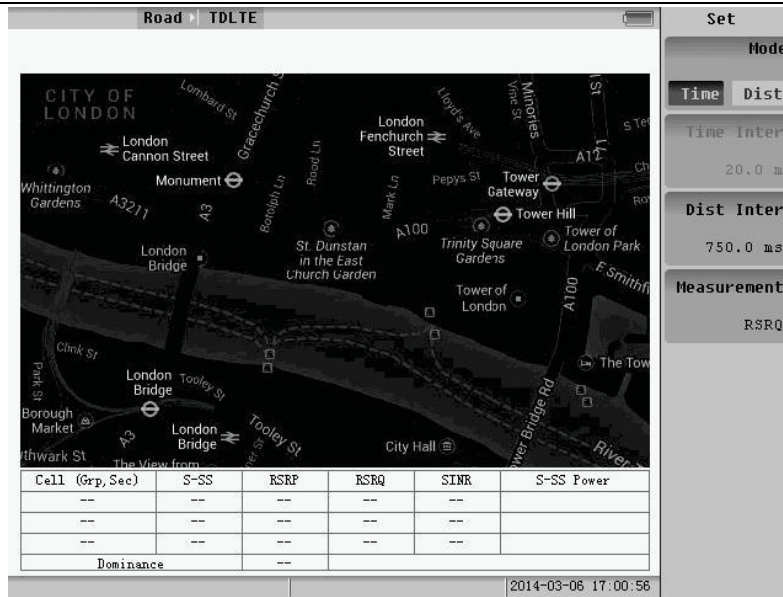

Fig.6.25 Setting menu

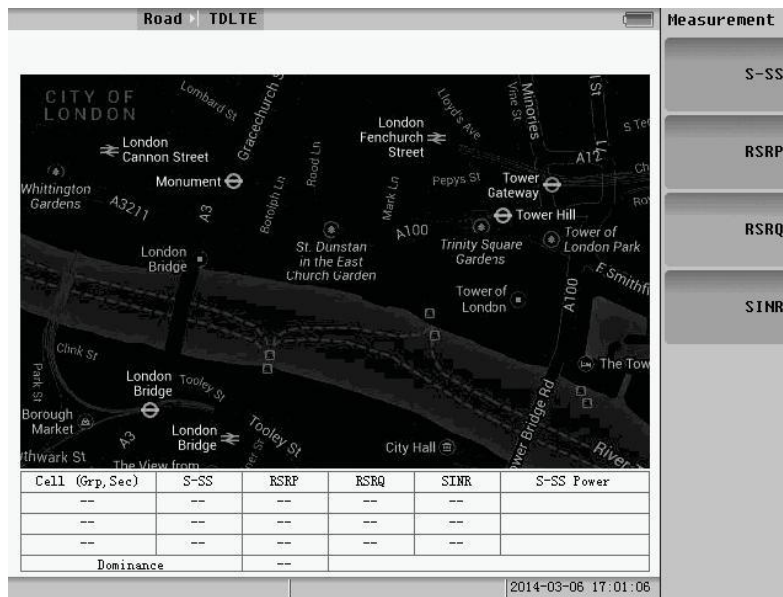

Fig.6.26 Measurement menu

The other operations of TDLTE outdoor are same as the step of SS outdoor.

6.4 FDLTE Outdoor

Select the “FDLTE outdoor” to enter the measurement menu.

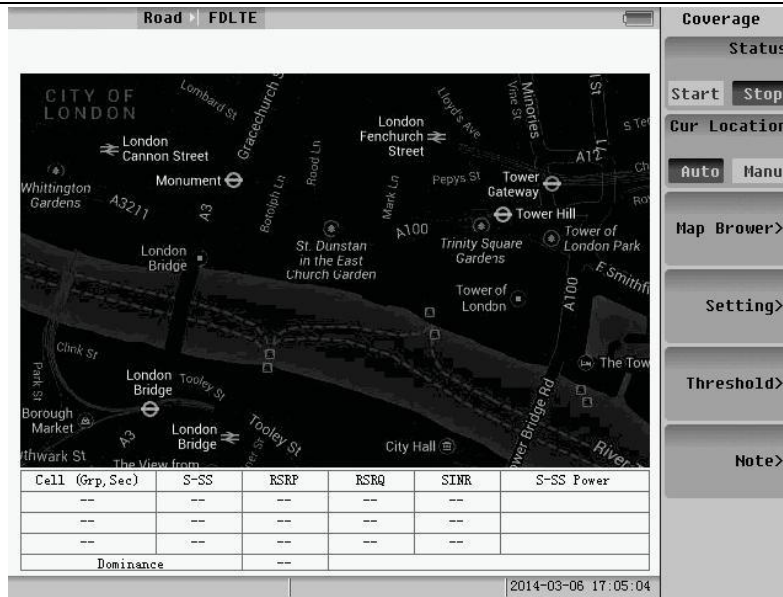

Fig.6.27 FDLTE outdoor menu

The operations of FDLTE outdoor are same as the step of TDLTE outdoor.

6.5 Net Clean Outdoor

Select the “Net Clean outdoor” to enter the measurement menu.

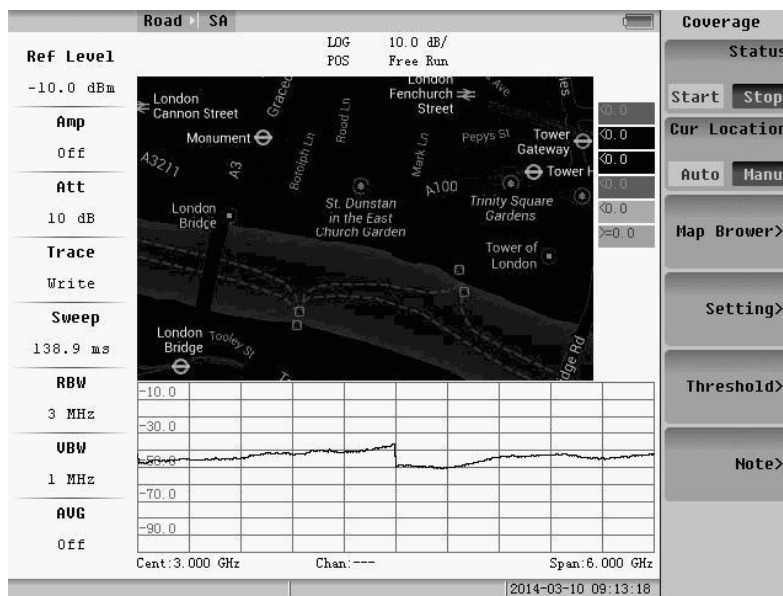

Fig.6.28 Net clean outdoor menu

Setting: press to enter the setting menu. You can select time mode or distance mode to measure. And if you choose time mode, the time interval can be set. And press the key of location to choose where you want to save the location.

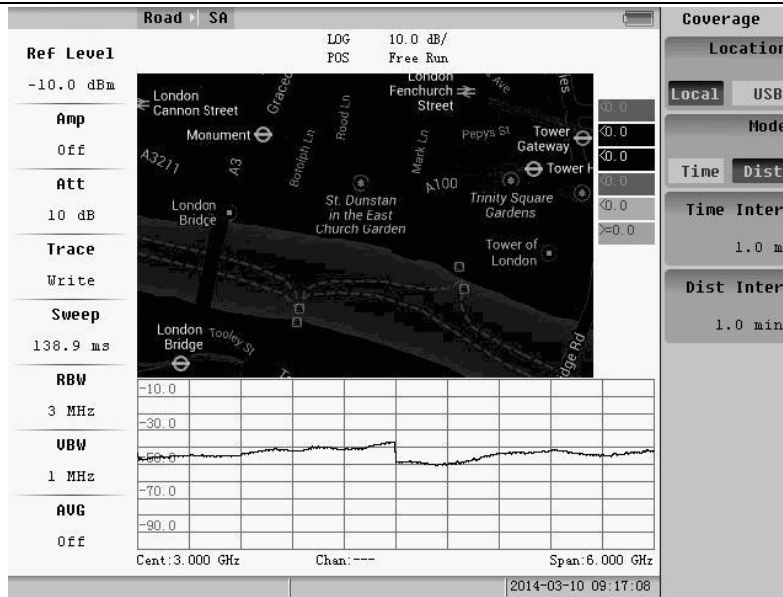

Fig.6.29 Setting menu

The other operations of TDLTE outdoor are same as the step of SS outdoor.

Press the **FREQ PEAK AMPTD MARK CPL** function keys to set frequency, PEAK, amplitude, mark and other basic settings separately.

Chapter 7 Track Generator

After tracking source option to be installed, transmission measurements can be done. Press the **MODE** button, and select the Track Generator of measurement mode to enter following menu.

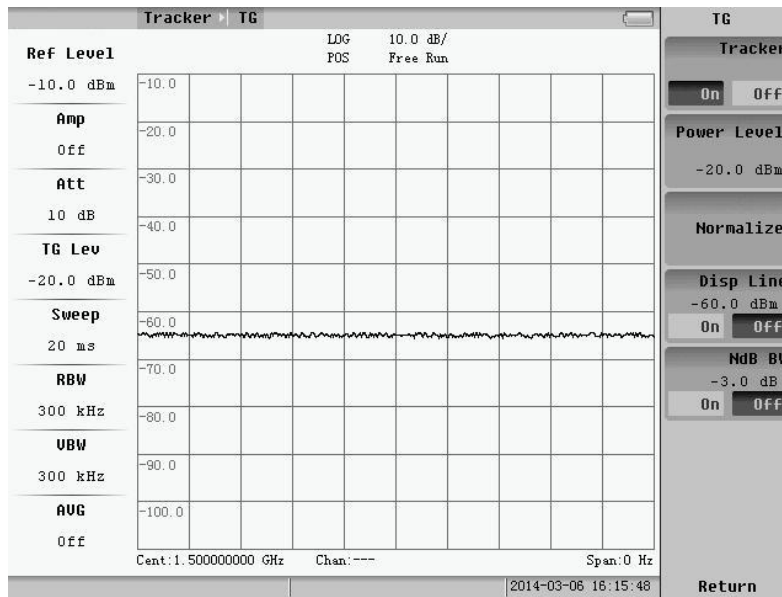

Fig.7.1 Track generator menu

Track Generator function need to connect RF OUT and RF IN.

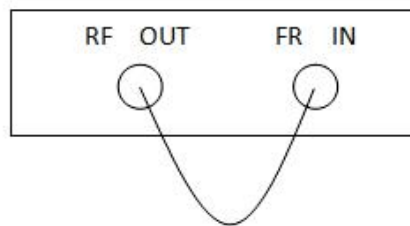

Fig.7.2 Track generator's wiring

Tracker: press to open or close Track Generator.

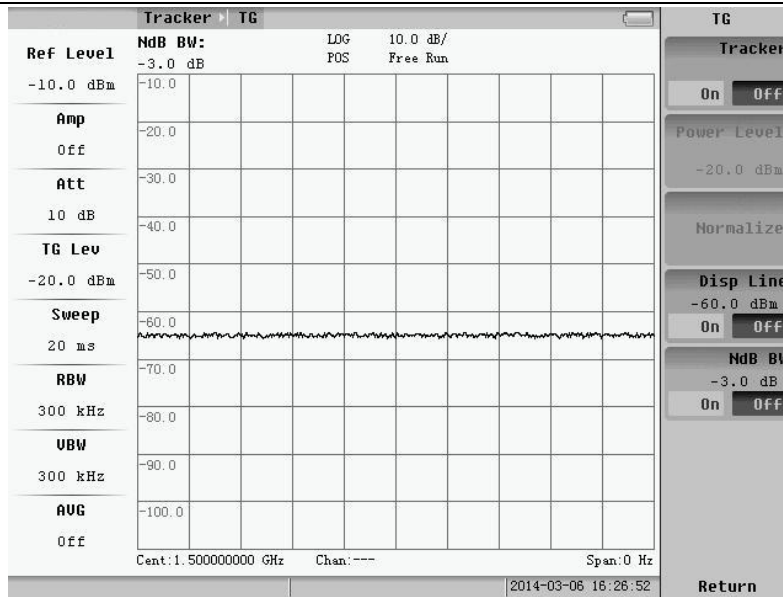

Fig.7.3 Rack generator closed

Power Level: if the Tracker is open, press to input it. Normalize: press to make the wave a line.

Disp Line: press to open or close it. If it's opened, you can change it by inputting.

Ndb BW: press to open or close it and it is used to measure current wave's bandwidth of Ndb. It is usually used to measure the 3db bandwidth of filter.

Chapter 8 File Managing

This chapter provides an overview of File Saving and File Managing.

8.1 File Saving

Pressing SAVE key, the submenu of it will appear. We can switch the file type during Image, Status and Trace + Status.

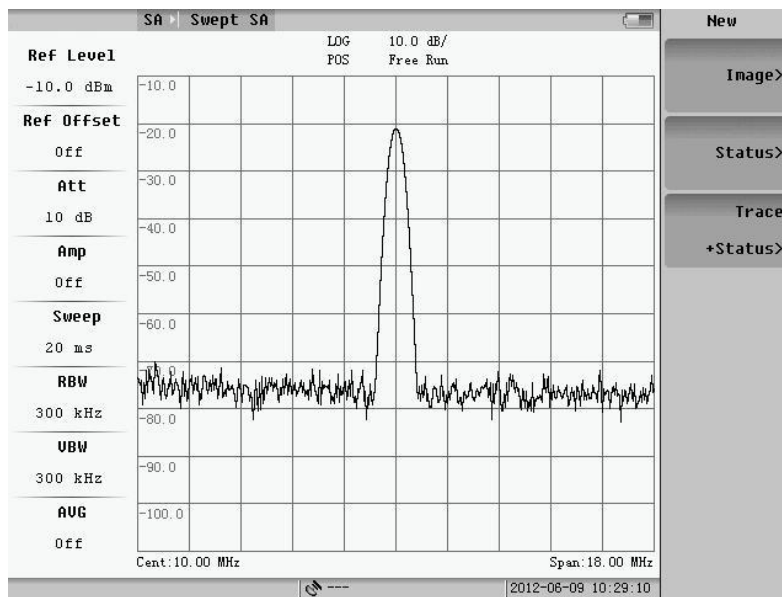

Fig.8.1 File saving

8.1.1 Image file saving

Pressing “Image” soft-key, the follow menu will appear, and the image files are BMP file, which are post fixed by “.bmp ”, as 16 bits.

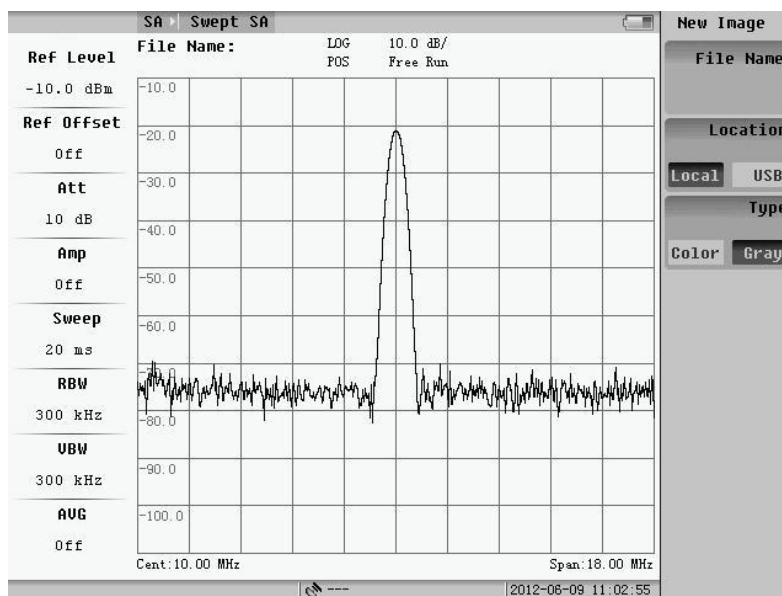

Fig.8.2 Image saving

1. File Name

Pressing “File name” soft-key, the follow menu will appear. Input the file name and then press the “Entre” soft-key. The file will be saved. The file name is made up by numbers and characters.

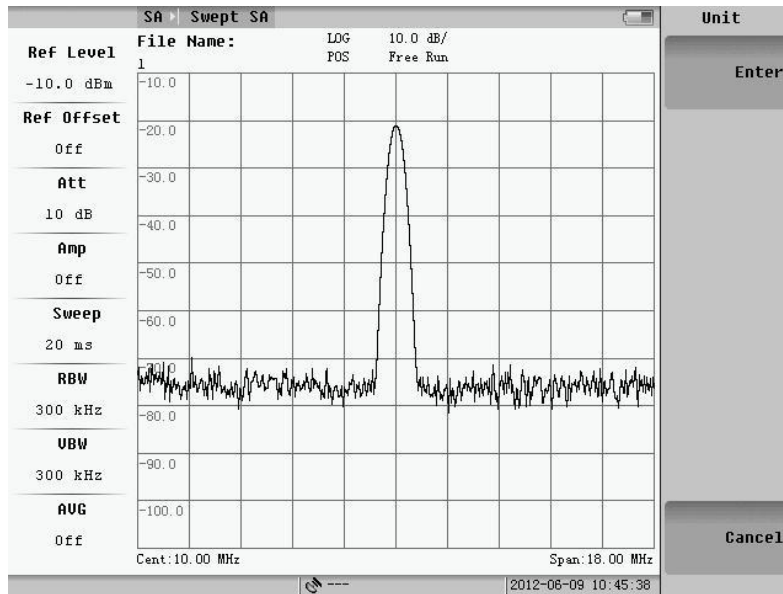

Fig.8.3 File name editing

2. Location

Pressing “Location” soft-key, we can switch the saving location between “local” and “USB”. If location is the local, the file will be saved in the folder “/bmp”; otherwise it will be saved into the root directory of the flash disk.

3. Image File Type

Pressing “Type” soft-key, we can switch the file type during Color and Gray.

8.1.2 Status file saving

Pressing “Status> ”soft-key, the following menu will appear .

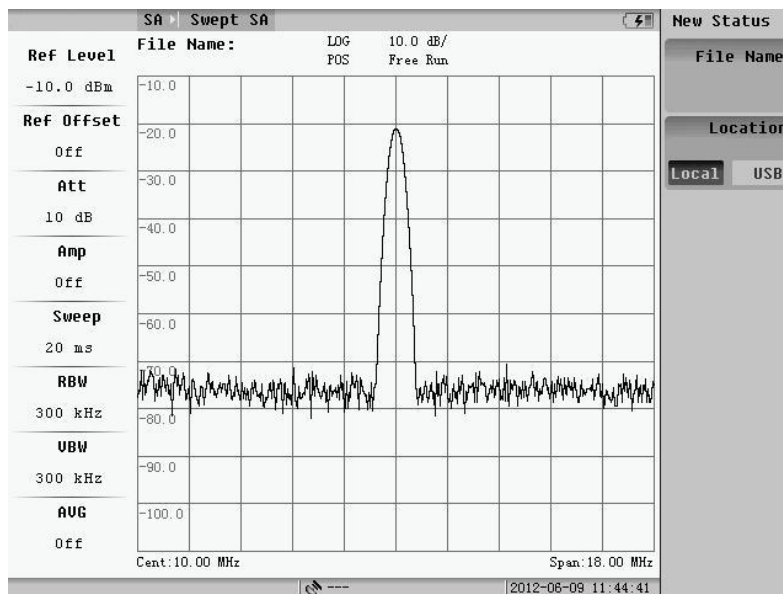

Fig 8.4 Status file saving

The method of saving is same as the method of image file. Inputting file name and then pressing “Enter” soft-key, the file will be saved. The status file is post fixed by “.sta ”. If location is the local, the file will be saved in the folder “/status”.

8.1.3 Trace+Status file saving

Pressing “Trace+Status”soft-key, the following menu will appear .

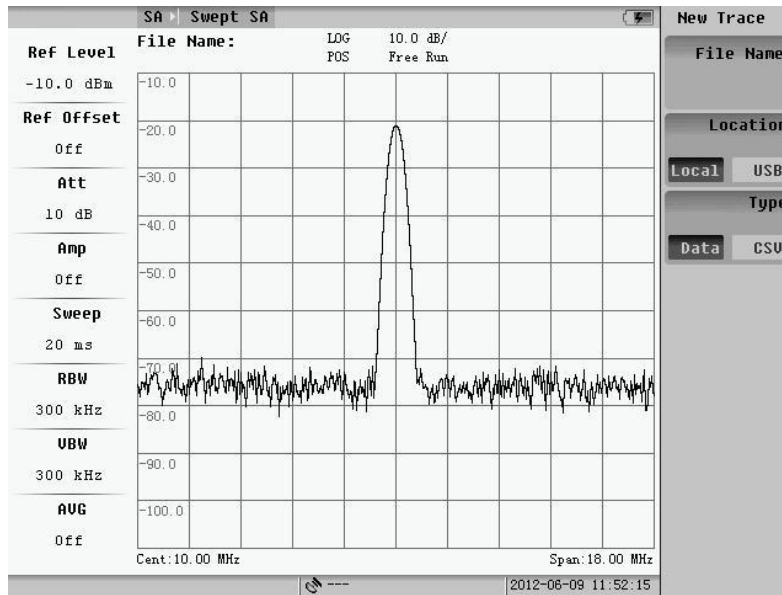

Fig.8.5 Trace+Status file saving

The method of saving is same as the method of image file. Inputting file name and then pressing “Enter” soft-key, the file will be saved. If location is the local, the file will be saved in the folder “/trace”

Pressing “Type” soft-key, well can switch the saving location during “Data” and “CSV”. If type is the “Data”, the status file is post fixed by “.tra ”; otherwise it will be post fixed by “.csv ”,which can be open by” Microsoft Office Excel”.

8.2 File Management

Pressing “Sys->File Manager” soft-key, the submenu will appear. We can switch the file type as Image, Status and Trace + Status.

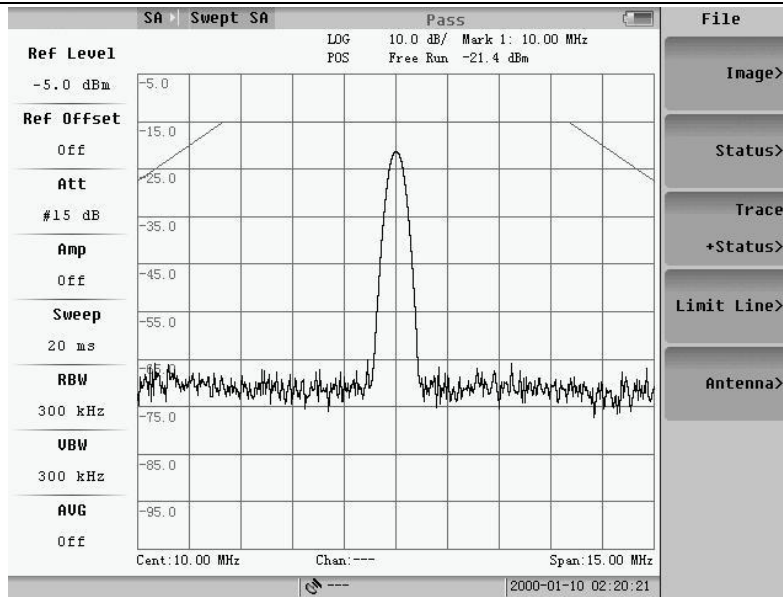

Fig 8.6 File managing

8.2.1 Image file management

Pressing “Image” soft-key, the follow menu will appear, and the dialog box will pop up.

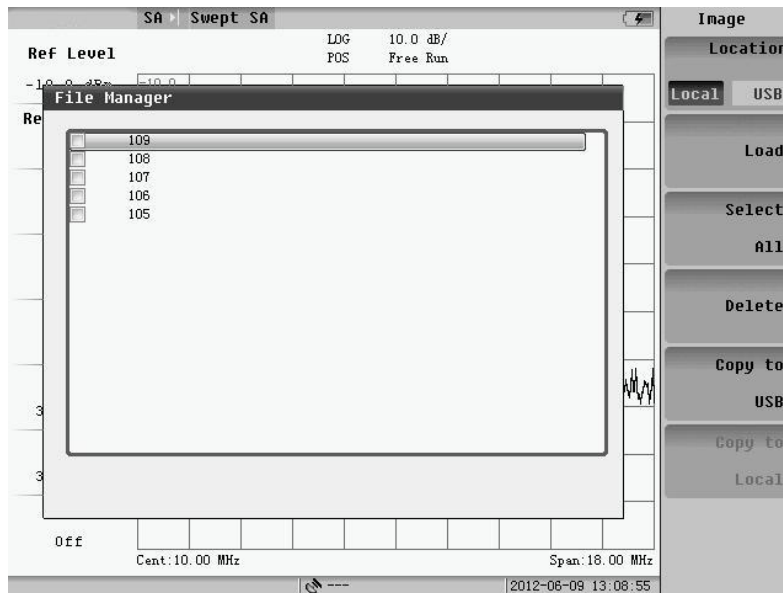

Fig.8.7 Image file management

1. File Selection

Pressing “Location” soft-key, we can switch the file paths between local and flash disk. All files in the selected location will be listed in the dialog box. If there is no flash disk, the warning will be in the note information position, shown as the figure below.

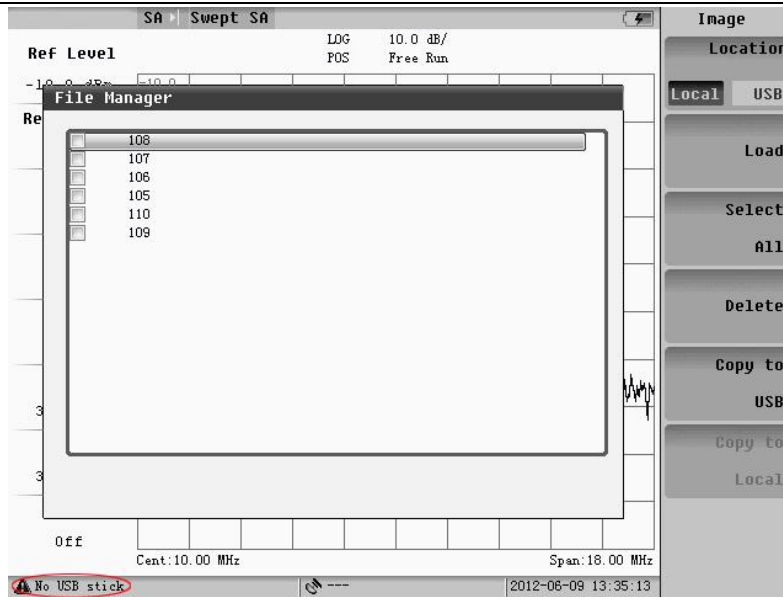

Fig.8.8 No flash disk

Set the cursor position on the file by pressing the “Up/Down” key or rotating the knob and then pressing ENTER key, the file will be selected.

Pressing the “Select All”, all files which are listed in the dialog box will be selected. The selected files will be marked by “√”.

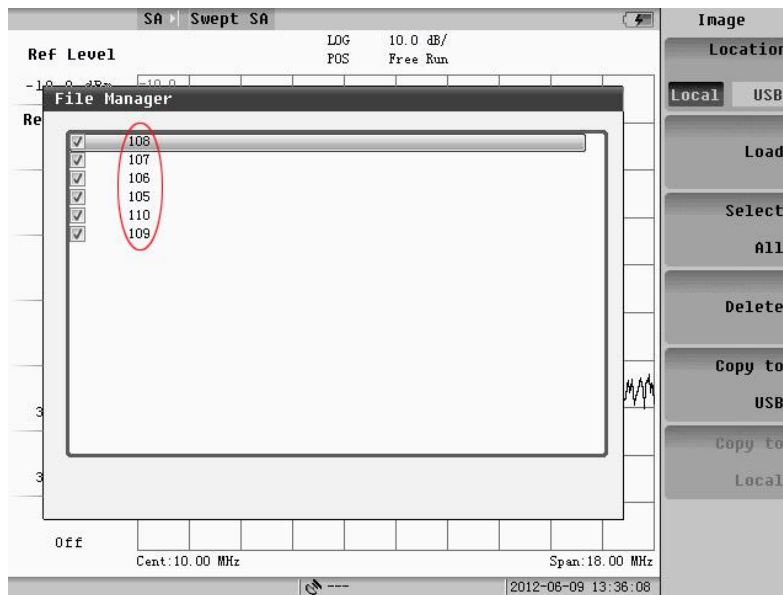

Fig.8.9 Selection file

2. Operation

The selected file will be deleted, loaded, and copied.

Delete: Delete the selected files.

Load: Open the image file in the instrument, which will be marked with yellow border, showed as the follow figure.

Press the **RETURN** to turn down the loading file mode.

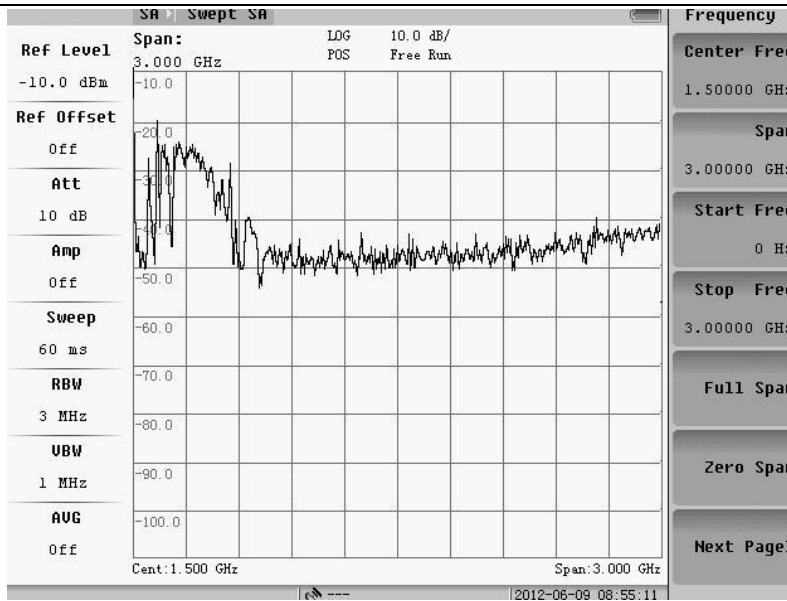

Fig.8.10 File loaded

Copy: Copy the selected files from local to flash disk or from local disk to local. If no flash disk, the operation of copying file is not allowed.

8.2.1 Image file management

Pressing “Image” soft-key, the follow menu will appear, and the dialog box will pop up.

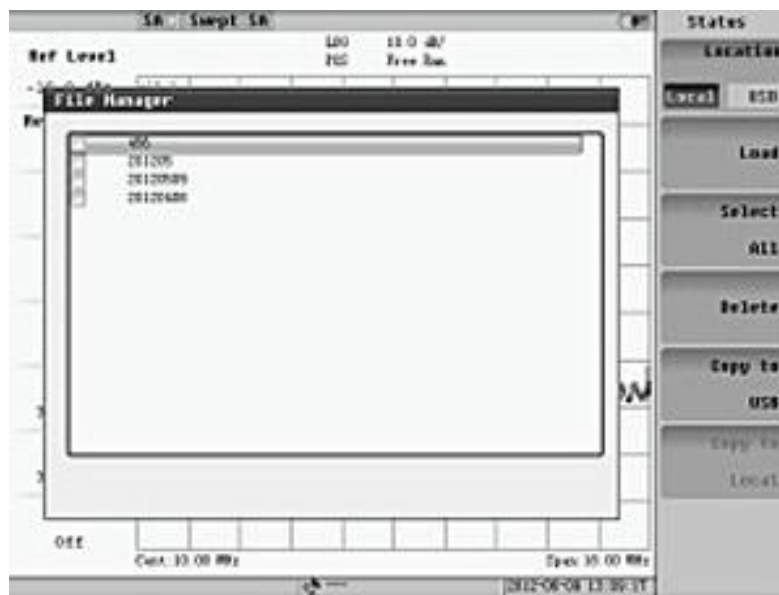

Fig.8.11 Status file management menu

The method of operation is same as the method of image file.

8.2.2 Trace+Status file management

Pressing “Image” soft-key, the follow menu will appear and the dialog box will pop up. The image files are BMP file, which are post fixed by “.bmp”, as 16 bits.

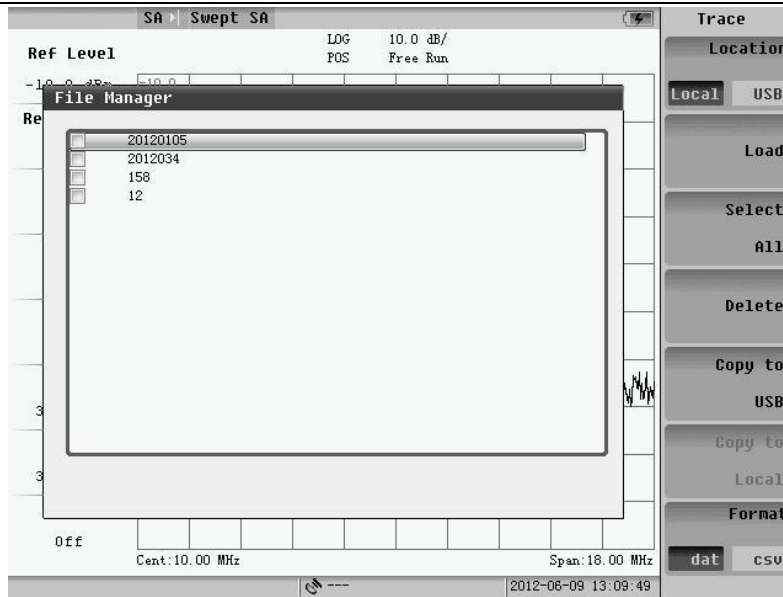

Fig.8.12 Trace+Status file management menu

We will choose the file type from “Data”and”CSV”. Then we can load, delete or copy files as same as the image operations.

8.2.3 Limit file management

Pressing “Image” soft-key, the follow menu will appear. The limit file management includes the Swept SA Down limit and Swept SA Up limit.

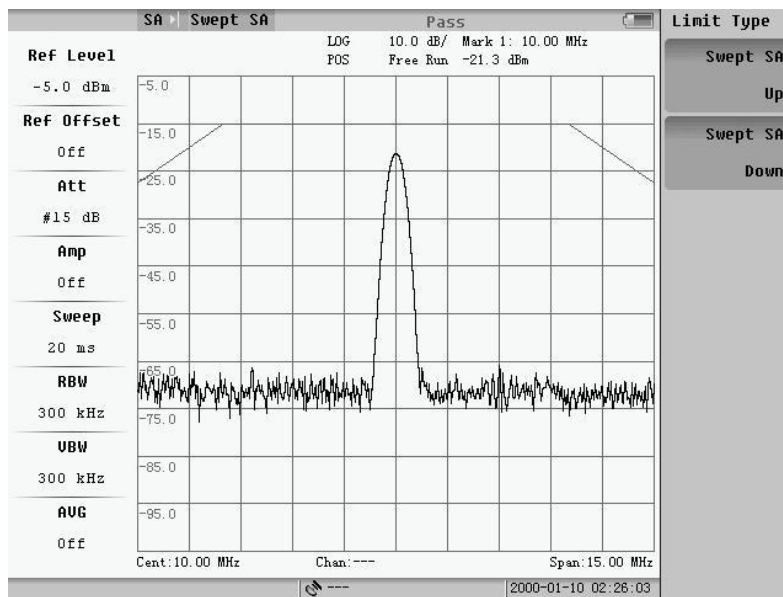

Fig.8.13 Limit file management menu

Pressing the Up or Down Limit, the dialog box will pop up. The limit files can be edited by ”Microsoft Office Excel”, which is post fixed by ”.csv ”.The files can copy the file from the flash disk or delete files as same as the image operations.

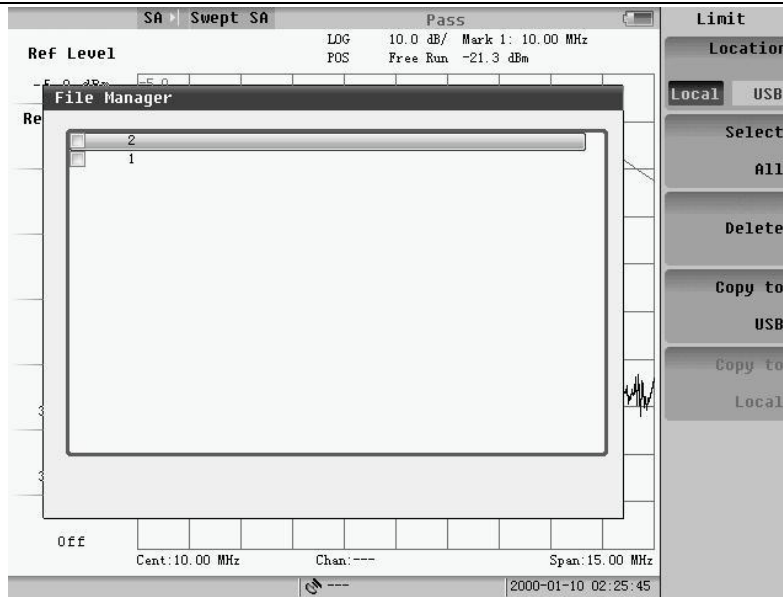

Fig.8.14 Limit file management dialog box

Chapter 9 Other Functions and Settings

This chapter mainly introduces the system parameter and inquiry system parameter and inquiry system information by pressing **SYS** key. The 9.1 Menu will pop up, and press "Next Page" the 9.2 menu will be shown.

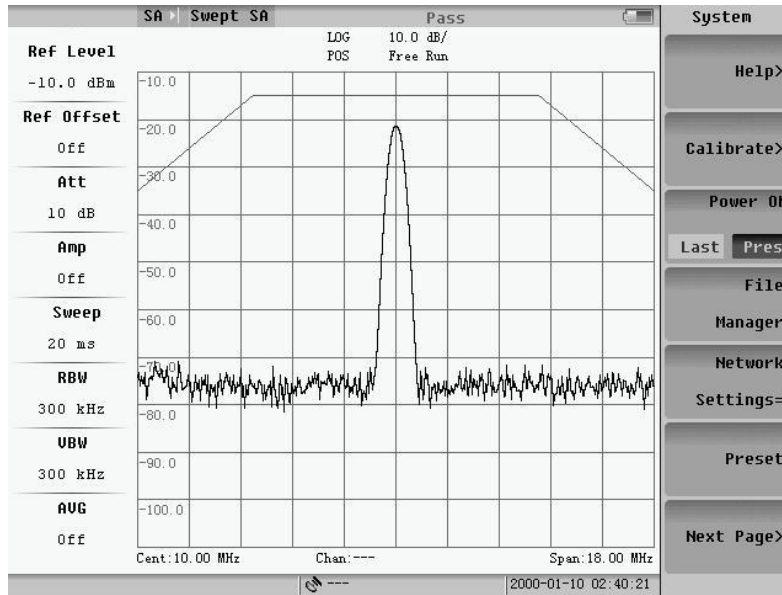

Fig.9.1 System menu (page 1)

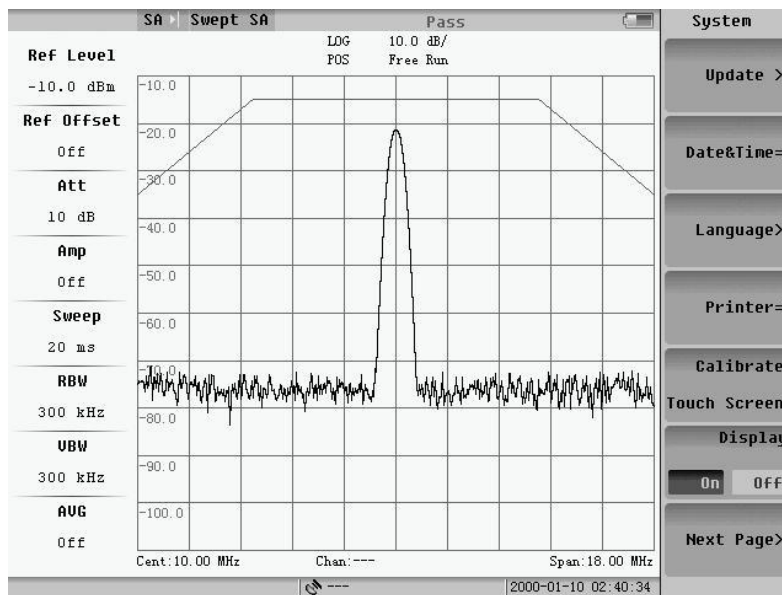

Fig.9.2 System menu (page 2)

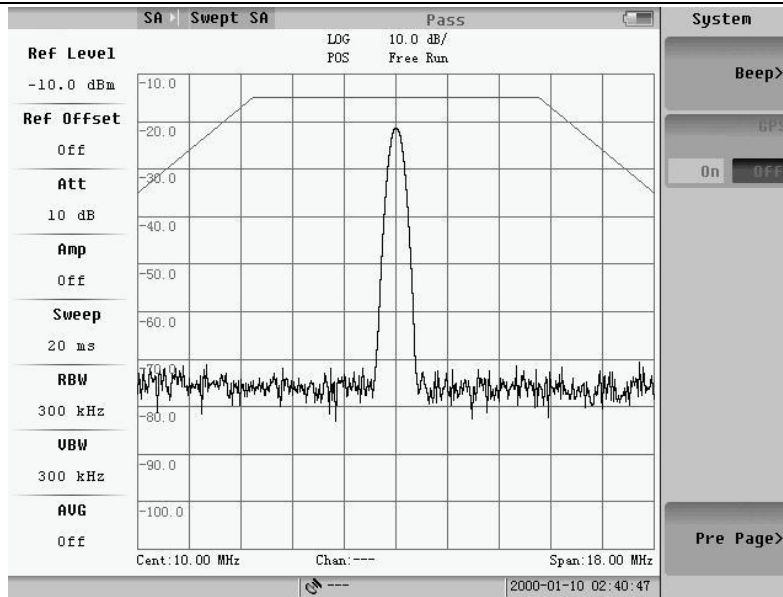

Fig.9.3 System menu (page 3)

9.1 System Calibration

For the analyzer to meet its specifications and characteristics the self-calibration routines should be performed periodically or whenever the ambient temperature changes.

System calibration includes frequency calibration and amplitude calibration. Frequency calibration is to rectify the frequency error caused by IF filter. Amplitude calibration is to rectify the amplitude error, which can be caused by window functions of different RBW or attenuators, so Amplitude calibration should be taken with different RBW or attenuators.

Allow the analyzer to warm up for 10 minutes before performing the following calibration steps:

Press "CAL" soft-key, and the menu will pop up.

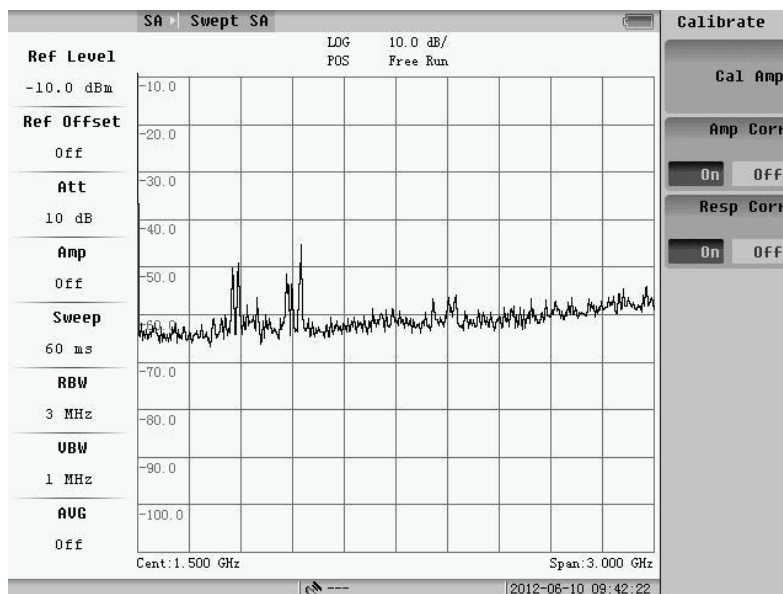

Fig.9.4 Calibration menu

NOTE: During the process of calibration, the instrument is unable to response to the keyboard commands except the

“RESET” key.

The second and third keys are "USE" and "CANCEL" function for calibration data and frequency response data. User can cancel the calibration according to the demand.

After select "cancel" mode, the dialog shown Fig.9.5 will pop up.

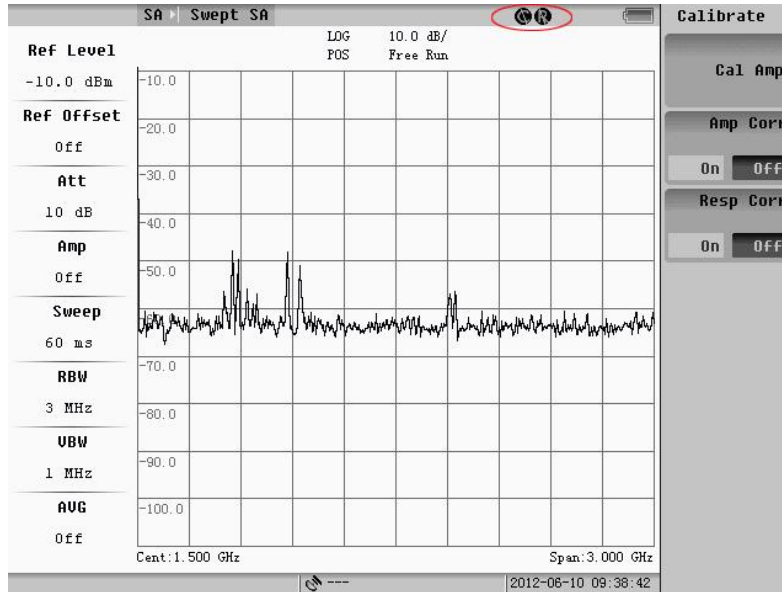

Fig.9.5 Calibration and response off

9.2 Help Menu

Press “Help” soft-key, and then the submenu will appear as Fig.9.6.

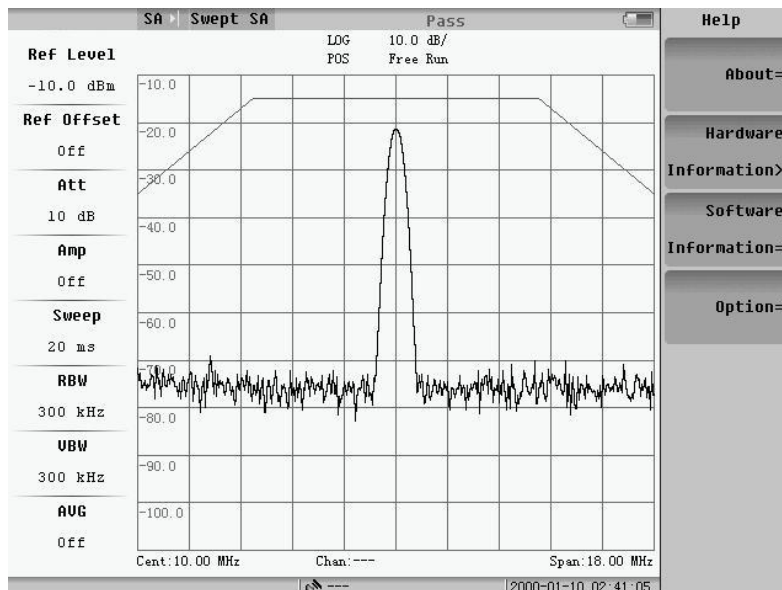

Fig.9.6 Help menu

Fig.9.7 shows series number, firmware version and etc. of the instrument. It will be closed if pressing enter key.

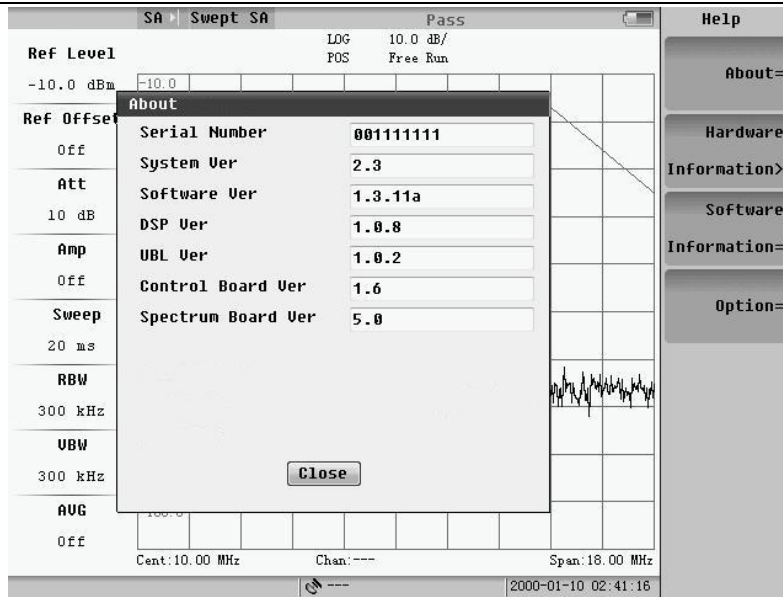

Fig.9.7 Instrument information

Figure 9-8 shows hardware information including the Total/free space of disk, battery status, temperature and etc. It will be closed if pressing enter key.

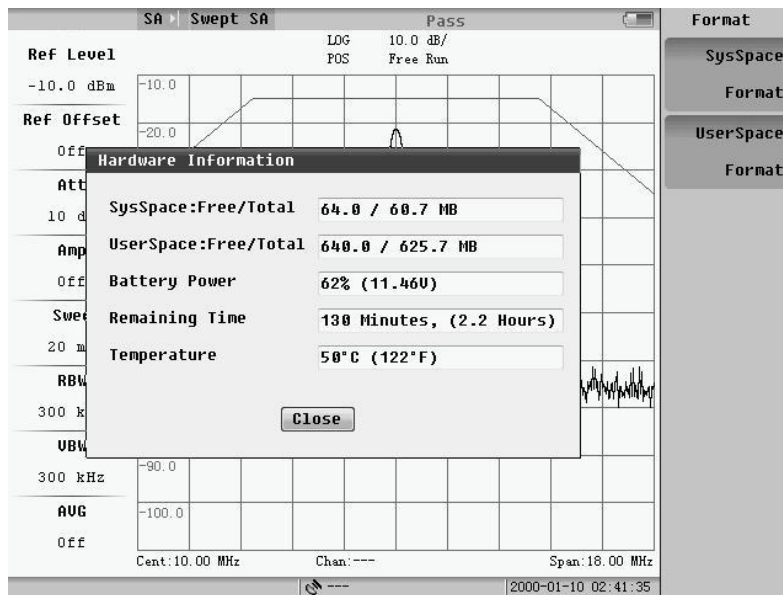

Fig.9.8 Hardware information

Press the syspace format or the userspace format, and then the confirm format dialog will pop up. If we choose “yes”, we will format the system space or the user space. Format any space, all the files on the space will be deleted.

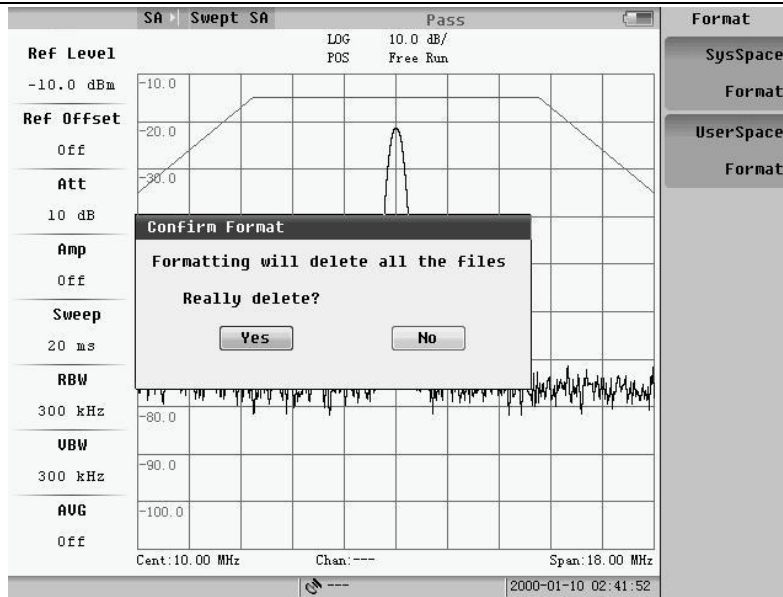

Fig.9.9 Format space

Fig.9.10 shows software information including the ARM and SPEC Software release time and etc. It will be closed if press enter key.

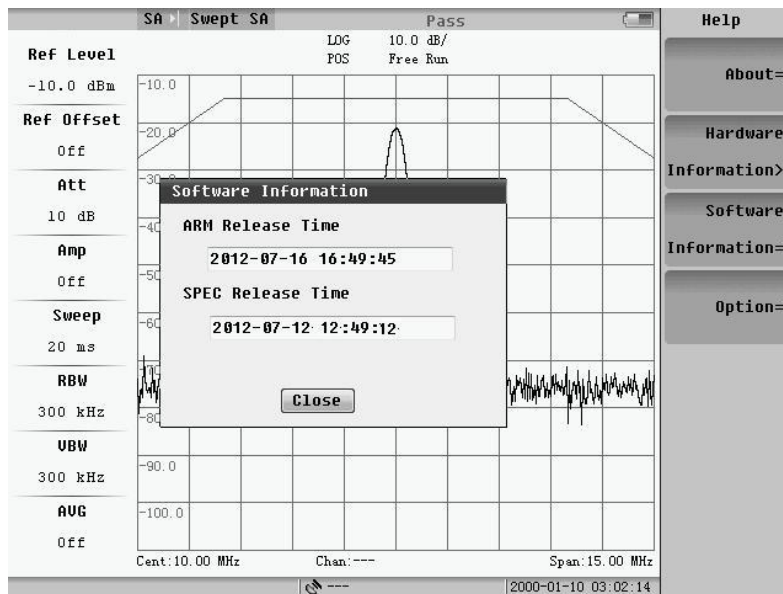

Fig.9.10 Software information

Fig.9.11 shows the option information. It will be closed if press enter key.

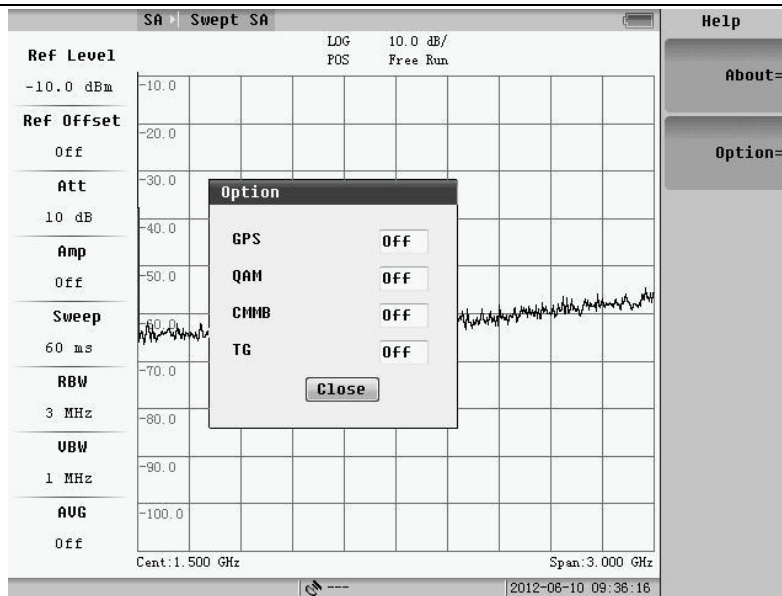

Fig.9.11 Option information

9.3 System Configuration

Setup some system parameters, including display, communication, language, and etc.

9.3.1 Power on status selection

Pressing "Power ON" soft-key, we can set the measurement status of next power on between Last and Pres as last measurement or the default measurement. The default one is the Swept SA mode.

9.3.2 Preset

Pressing "Preset" soft-key, we can set the measurement as the default measurement. The default one is the Swept SA mode.

9.3.3 Network setting

Now S5800E series only supports LAN communication. The S5800E can be remote controlled by PC. Please refer to chapter 6. Press the Network Settings key, and the follow menu will pop up.

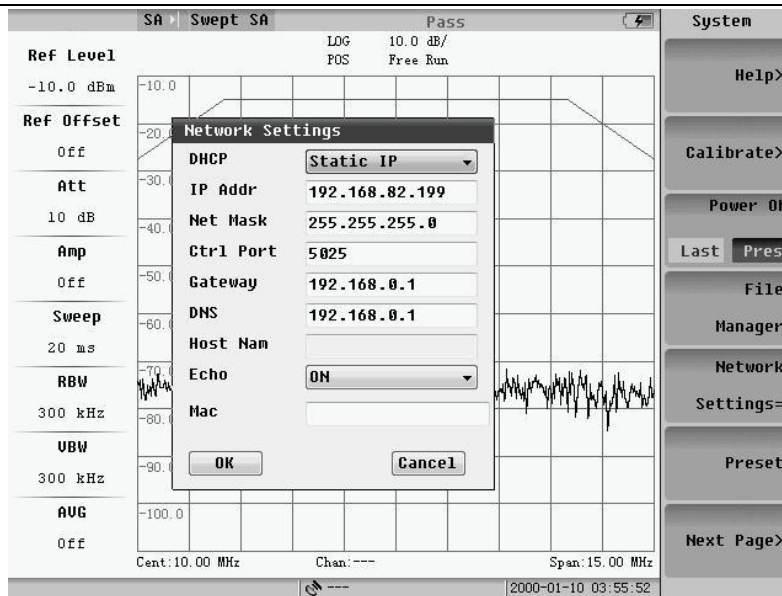

Fig.9.12 Network setting

- 1) **DHCP:** Select between DHCP IP mode and Static IP mode. The default is a static IP, which can be selected through the drop-down list;
- 2) **IP address:** IP address of the button in the network settings, you can set the machine's IP address;
- 3) **Subnet Mask:** use a fixed IP environment;
- 4) **Port Number:** port number of network connections, default 5025;
- 5) **Gateway:** IP address of the gateway;
- 6) **DNS:** IP address of DNS server;
- 7) **Host Name:** Specifies the host name.

If it dynamically obtains an IP, the follow dialog will pop up:

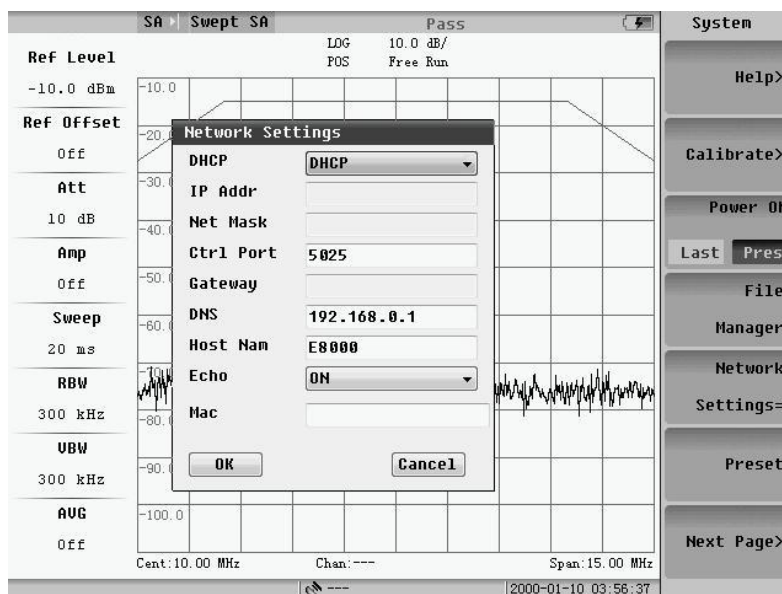

Fig.9.13 Obtain IP automatically

By up/down key or knob, user can move the focus to "enter" or "cancel" item.

9.3.4 Printer setting

Press the “Printer” soft-key, and then the following menu will pop up.

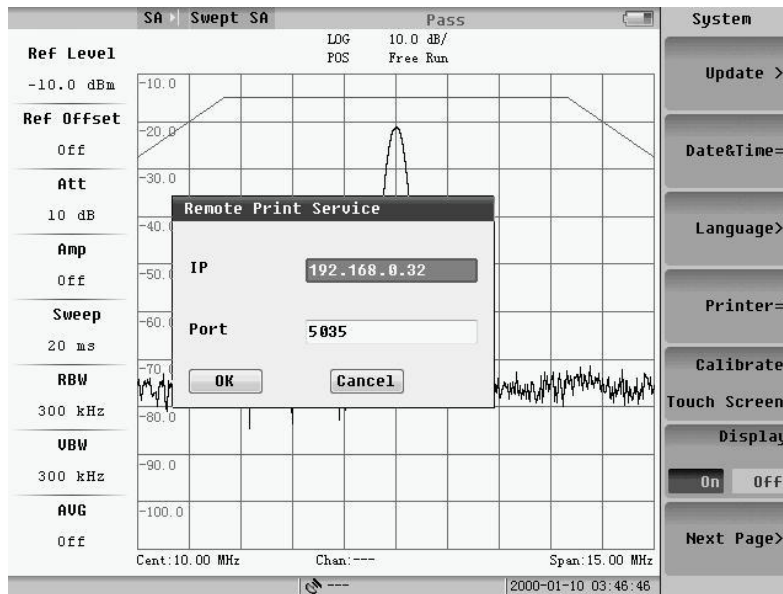

Fig.9.14 Printer setting

We can input the IP number and the port number of the printer. The printer will be netted.

9.3.5 Data & Time setting

Press the “Data & Time” soft-key, and then the following menu will pop up.

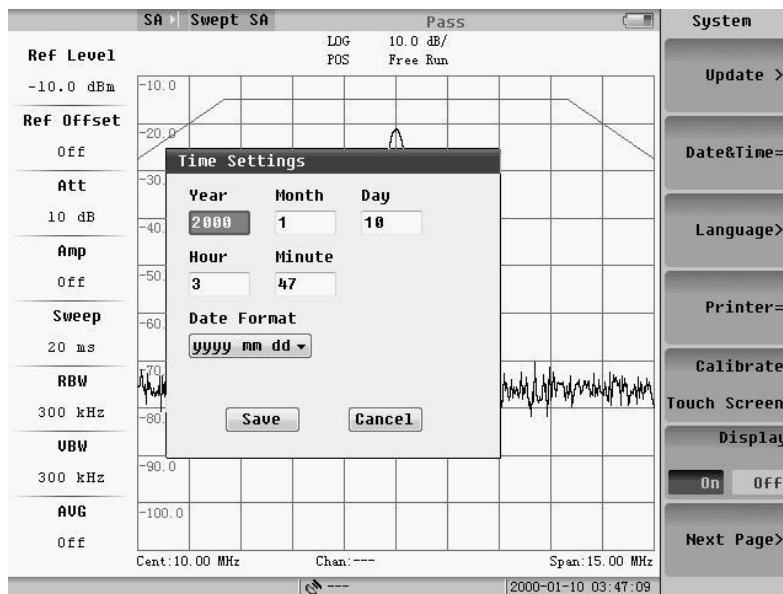

Fig.9.15 Data and Time

By up/down key or knob, user can move the blue cursor to location of parameter, and you can modify the date and time through the numeric keys to enter numbers. The date display format can be selected via the drop-down list. There are three formats for the election. Click "OK" to save the settings and close the dialog, "Cancel" to give up the settings, and close the dialog box.

9.3.6 Buzzer config

The S5800E series has a built-in buzzer for buzzing when error occurred. User can set the buzzer switch operation. Press the "Beep Settings", and the menu will pop up shown as below.

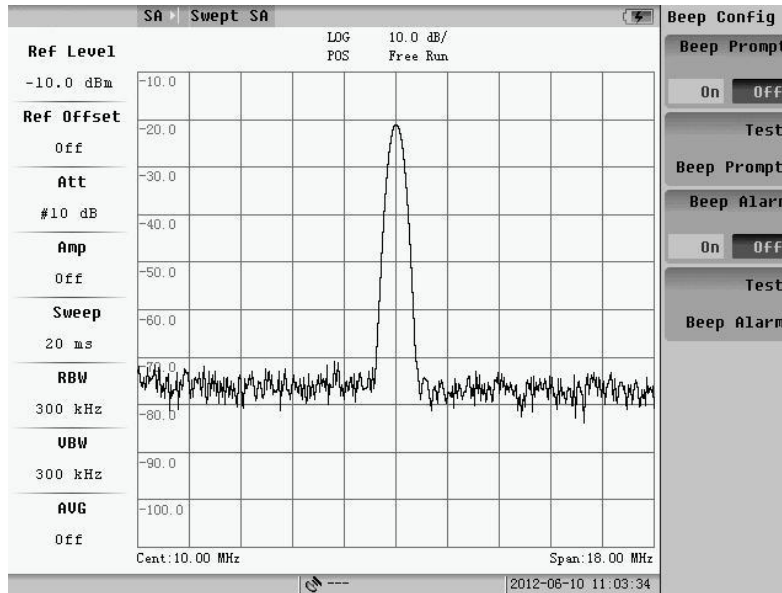

Fig.9.16 Buzzer setting

The difference of the prompt beep and alarm beep is the size of the volume. User can test the alarm function of the two voices by pressing "Test peep function". Press the test function key, and buzzer will be forced to beep once. When buzzer is open, there will be a corresponding voice prompt with each pressing of a button. The alarm buzzer is open, when illegal operation or low battery occurred, there will be an audible alarm.

9.3.7 GPS setup

The user has purchased GPS, and under the opened state, the user can artificially enable or disable the GPS functionality, the user interface shown as below:

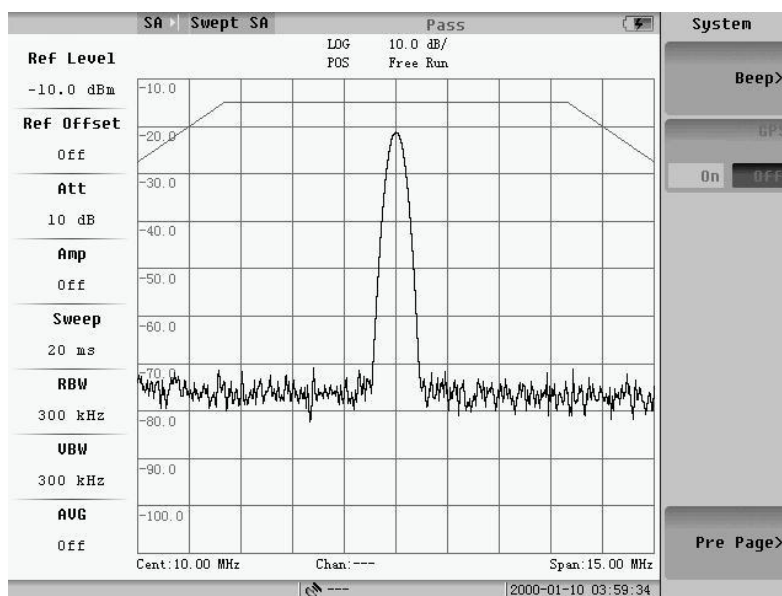

Fig.9.17 GPS setting

If user has not bought the GPS option, the button is gray.

9.4 Software Update

When you need to upgrade software, contact our company for the latest firmware. Software can only be upgraded by USB disk mode.

Before updating, copy upd_file.dat and upd_ver.txt into the root directory of the U disk. In the second page of the System Menu, select the "upgrade" soft key, the below menu will pop up. Press the "OK" to upgrade, and press "Cancel" to return to the previous screen.

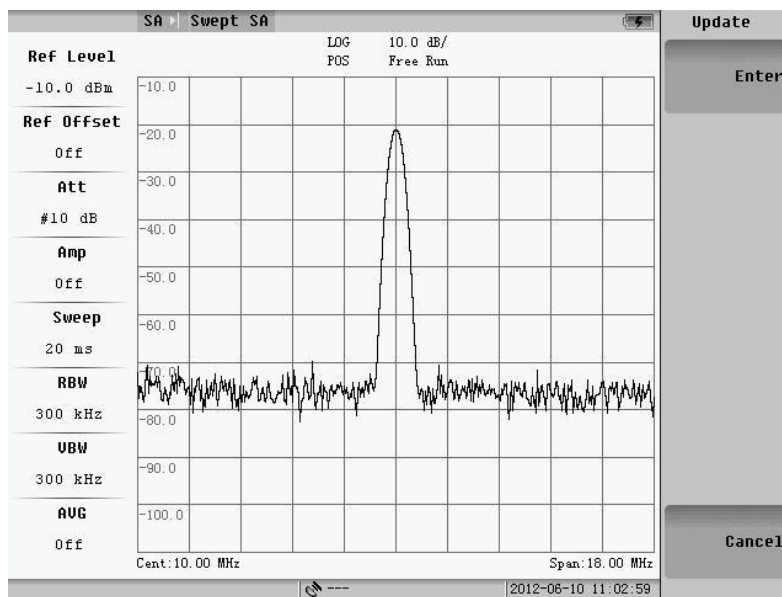

Fig.9.18 Upgrade

It will display a graphic during updating normally. There will be prompt if update successfully. If the upgrade is unsuccessful, an error message will be displayed on the screen for the failure reason.

Chapter 10 Programming Guide

10.1 SCPI Language Basics

This section is not intended to teach you everything about the SCPI (Standard Commands for Programmable Instruments) programming language. The SCPI Consortium or IEEE can provide that level of detailed information.

For more information, please refer to:

IEEE Standard 488.1-1987, IEEE Standard Digital Interface for Programmable Instrumentation. New York, NY, 1998.

IEEE Standard 488.2-1987, IEEE Standard Codes, Formats, Protocols and Comment Commands for Use with ANSI/IEEE Std488.1-1987. New York, NY, 1998.

10.1.1 Command keyword and syntax

The instrument does not distinguish between upper and lower case letters. In the documentation, upper case letters indicate the short form of the keyword. The lower case letters indicate the long form of the keyword. Either form may be used in the command.

Example: Sens:Freq:Star 1.5 mhz is the same as SENSE:FREQ:start 1.5 MHz

NOTE: The command SENS:FREQU:STAR is not valid because FREQU is neither the short, nor the long form of the command. Only the short and long forms of the keywords are allowed in valid commands.

10.1.2 Creating valid commands

Commands are not case sensitive and there are often many different ways of writing a particular command. These are examples of valid commands for a given command syntax:

Command Syntax	Sample Valid Commands
[SENSe:]BANDwidth[:RESolution] <freq>	The following sample commands are all identical. They will all cause the same result. ➤ Sense:Band:Res 1700 ➤ sens:band 1.7KHZ ➤ band 1.7kHz
[:SENSe]:DETEctor[:FUNCTion] NEGative POSitive SAMPLE	➤ DET:FUNC neg ➤ Detector:Func Pos
INITiate:CONTInuous ON OFF 1 0	The sample commands below are identical. ➤ INIT:CONT ON ➤ init:continuous 1

10.1.3 Special characters in commands

Char	Meaning	Example
	A vertical stroke between parameters indicates alternative choices. The effect of the command is different depending on which parameter is selected.	Command: TRIGger:SOURce EXTernal INTernal LINE The choices are external, internal, and line. Ex: TRIG:SOURCE INT is one possible command choice.
	A vertical stroke between keywords indicates identical effects exist for both keywords. The command functions the same for either keyword. Only one of these keywords is used at a time.	Command: SENSE:BANDwidth BWIDth: OFFSet Two identical commands are: Ex1: SENSE:BWIDTH:OFFSET Ex2: SENSE:BAND:OFFSET
[]	Keywords in square brackets are optional when composing the command. These implied keywords will be executed even if they are omitted.	Command: [SENSe:]BANDwidth[:RESolu tion]:AUTO The following commands are all valid and have identical effects: Ex1: bandwidth:auto Ex2: band:resolution:auto Ex3: sense:bandwidth:auto
< >	Angle brackets around a word, or words, indicates they are not to be used literally in the command. They represent the needed item.	Command: SENS:FREQ <freq> In this command example the word <freq> should be replaced by an actual frequency. Ex: SENS:FREQ 9.7MHz.

10.1.4 Parameters in commands

There are four basic types of parameters: Booleans, keywords, variables and arbitrary block program data.

OFF|ON|0|1

(Boolean) This is a two state Boolean-type parameter. The numeric value 0 is equivalent to OFF. Any numeric value other than 0 is equivalent to ON. The numeric values of 0 or 1 are commonly used in the command instead of OFF or ON. Queries of the parameter always return to a numeric value of 0 or 1.

Keyword

The keywords that are allowed for a particular command are defined in the command syntax description.

UP –parameters value is increasing

DOWN –parameters value is decreasing

Units

Numeric variables may include units. The valid units for a command depend on the variable type being used. See the following variable descriptions. The indicated default units will be used if no units are sent. Units can follow the numerical value with, or without, a space.

10.1.5 Variable parameters

Parameters	Means	Default Unit (Optional)	Acceptable Units
<integer>	An integer value	---	---
<real>	A floating point number	---	---
<freq>	A positive rational number	Hz	Hz, kHz, MHz, GHz
<bandwidth>			
<time>	A rational number	seconds	ks s, ms, us, ns
<seconds>			
<ampl>	A rational number	dBm	dBm, dBmV, dBuV
<rel_power>	A positive rational number	dB	dB
<rel_ampl>			
<string> characters	A series of alpha numeric	---	---

10.1.6 Block program data

Some parameters consist of a block of data. There are a few standard types of block data. Arbitrary blocks of program data can also be used. <trace> Is an array of rational numbers corresponding to displayed trace data.

<arbitrary block data>

It consists of a block of data bytes. The first information sent in the block is an ASCII header beginning with #. The block is terminated with a semi-colon. The header can be used to determine how many bytes are in the data block. There are no units.

Block data example:

Suppose the header is #512320.

- The first digit in the header (5) tells you how many additional digits/bytes there are in the header.
- The 12320 means 12 thousand, 3 hundred, 20 data bytes follow the header.
- Divide this number of bytes by your current data format (bytes/data point), either 8 (for real, 64), or 4 (for real,32). For this example, if you're using real64 then there are 1540 points in the block.

10.2 Instructions

10.2.1 Common command

Command	Means
*RST	Set instrument reset
*IDN? <string>	Get serial number
*OPT	Get option information

Ex1: Get the serial number
 Command: *IDN?
 Return: Instrument name, SN and factory name

10.2.2 System command

Command	Means
UPGRade	Software Upgrade
DISPlay:ENABle<Boolean> DISPlay:ENABle?	Set /Get the displays function state

10.2.3 Spectrum control command

1. Frequency

Command	Means
[SENSe:]FREQuency:CENTer<freq> [SENSe:]FREQuency:CENTer?	Set /Get the center frequency
[SENSe:]FREQuency:STARt <freq> [SENSe:]FREQuency:STARt?	Set /Get the start frequency
SENSe:]FREQuency:STOP <freq> [SENSe:]FREQuency:STOP?	Set /Get the stop frequency
[SENSe:]FREQuency:CENTer:STEP <freq> [SENSe:]FREQuency:CENTer:STEP?	Set /Get the frequency step
[SENSe:]FREQuency:CENTer:STEP:AUTO <Boolean> [SENSe:]FREQuency:CENTer:STEP:AUTO?	Set /Get the step auto state
[SENSe:]FREQuency:SPAN <freq> [SENSe:]FREQuency:SPAN?	Set /Get span
[SENSe:]FREQuency:SPAN:FULL	Set span to full span
[SENSe:]FREQuency:SPAN:PREVious	Set span to previous span

Ex1: Set the center frequency to 300.33 MHz
 Command: FREQ:CENT 300.33 MHz

Ex2: Get the frequency step auto state
 Command: FREQuency:CENT:Step:AuTO?
 Return: ON

2. Amplitude

Command	Means
DISPlay:WINDow:TRACe:Y[:SCALE]:RLEV el <ampl> DISPlay:WINDow:TRACe:Y[:SCALE]:RLEV el?	Set /Get the reference level
UNIT:POWer DBM DBMV DBUV V MV UV NV UNIT:POWer?	Set /Get the unit of the ref
[:SENSe]:POWer[:RF]:ATTenuation < rel_ampl > [:SENSe]:POWer[:RF]:ATTenuation?	Set /Get the attenuation
[:SENSe]:POWer[:RF]:ATTenuation:AUTO <Boolean> [:SENSe]:POWer[:RF]:ATTenuation:AUTO ?	Set /Get the attenuation auto state
[:SENSe]:POWer[:RF]:GAIN[:STATe] <Boolean> [:SENSe]:POWer[:RF]:GAIN[:STATe]?	Set /Get the pre-amplifier state
DISPlay:WINDow:TRACe:Y[:SCALE]:SPACi ng LOGarithmic LINear DISPlay:WINDow:TRACe:Y[:SCALE]:SPACi ng?	Set /Get the type to Log or Lin
DISPlay:WINDow:TRACe:Y[:SCALE]:PDIVI sion < real > DISPlay:WINDow:TRACe:Y[:SCALE]:PDIVI sion?	Set /Get the div/scale
DISPlay:WINDow:TRACe:Y[:SCALE]:RLEV el:OFFSet:STATe <Boolean> DISPlay:WINDow:TRACe:Y[:SCALE]:RLEV el:OFFSet:STATe ?	Set /Get the ref level offset state
DISPlay:WINDow:TRACe:Y[:SCALE]:RLEV el:OFFSet <rel_ampl > DISPlay:WINDow:TRACe:Y[:SCALE]:RLEV	Set /Get the ref level offset
[:SENSe]:IMPedance?	Get the impedance, 50 or 75

Ex1: Set the ref level to 73.6 dBuV
 Command: DISP:WIND:TRAC:Y:RLEV 73.6 dBuV

Ex2: Set to Linear mode
 Command: DISP:WIND:TRAC:Y:SPAC LOG

Ex3: Read the att
 Command: POW:ATT?

Return: 10

Means the current att is 10 dB

3. CPL (RBW, VBW, Sweep Time, Average)

Command	Means
[SENSe:]BANDwidth BWIDth[:RESolutio n]<bandwidth> [SENSe:]BANDwidth BWIDth[:RESolutio n]?	Set/ Get RBW
[SENSe:]BANDwidth BWIDth[:RESolutio n]:AUTO <Boolean> [SENSe:]BANDwidth BWIDth[:RESolutio n]:AUTO?	Set /Get the RBW auto state
[SENSe:]BANDwidth BWIDth:VIDeo <freq> [SENSe:]BANDwidth BWIDth:VIDeo?	Set/ Get VBW
[SENSe:]BANDwidth BWIDth:VIDeo:AUT O <Boolean> [SENSe:]BANDwidth BWIDth:VIDeo:AUT O?	Set /Get the VBW auto state
[SENSe:]SWEep:TIME <seconds > [SENSe:]SWEep:TIME?	Set/ Get sweep time
[SENSe:]SWEep:TIME:AUTO <Boolean> [SENSe:]SWEep:TIME:AUTO?	Set /Get the sweep time auto state
INITiate:CONTInuous <Boolean> INITiate:CONTInuous?	Set /Get the continuous state
[SENSe:]AVERAge[:STATe] <Boolean> [SENSe:]AVERAge[:STATe]?	Set /Get the average state
[SENSe:]AVERAge:COUNT <integer> [SENSe:]AVERAge:COUNT?	Set /Get the times of average
COUPlE ALL NONE COUPlE?	Set /Get the auto all state
SPECtrum:CAPTurE <Boolean> SPECtrum:CAPTurE?	Set /Get the capture state

Ex1: Set the RBW to 300kHz

Command: BWIDth 300 KHz

Ex2: Get sweep time

Command: SWEEP:TIME?

Return: 20000000

Means the current sweep time is 20ms.

Ex3: Set sweep time to 1.5s

Command: SWEEP:TIME 1.5s

Ex4: Get the average state

Command: AVER?

Return: OFF

Means the average is off.

Ex5: Set RBW,VBW sweep time to auto

Command: COUPLe ALL

4. Detector, Trigger, Demodulate

Command	Means
[SENSe:]DETEctor[:FUNction] POSitive NEGative SAMPl AVERage NO RMAL [SENSe:]DETEctor[:FUNction]?	Set /Get the detector
TRIGger[:SEQuence]:SOURce IMMediate VIDeo LINE TRIGger[:SEQuence]:SOURce?	Set /Get the trigger source
TRIGger[:SEQuence]:VIDeo:LEVel < percent > TRIGger[:SEQuence]:VIDeo:LEVel?	Set /Get the percent of video level
TRIGger[:SEQuence]:SLOPe POSitive NEGative TRIGger[:SEQuence]:SLOPe?	Set /Get the trigger slope
TRIGger[:SEQuence]:STANdard PAL NTSC TRIGger[:SEQuence]:STANdard?	Set /Get the trigger standard
TRIGger[:SEQuence]:FIEld ODD EVEN TRIGger[:SEQuence]:FIEld?	Set /Get the field trigger
TRIGger[:SEQuence]:LINE <integer> TRIGger[:SEQuence]:LINE?	Set /Get the line trigger
DEMode AM FM DEMode?	Set /Get the demode
DEMode:FMGain <freq> DEMode:FMGain?	Set /Get the FM gain

Ex1: Set the detector to samp 1

Command: DETector[:FUNction] SAMPl

Ex2: Get the trigger of source

Command: TRIGger[:SEQuence]:SOURce?

Return: IMMediate

Means the trigger of source is immeditate.

Ex3: Set the line trigger is line 16

Command: TRIGger:LINE 17

NOTE: The line trigger must be done before setting trigger, otherwise this statement doesn't work. Similar with the words (such as TRIGger) content, if not set, the setting (LINE) may not work. The same way works as below.

5. Mark

Command	Means
CALCulate:MARKer:STATe <Boolean> CALCulate:MARKer:STATe?	Set /Get the marker state
CALCulate:MARKer:FCOunt[:STATe]<Boolean> CALCulate:MARKer:FCOunt[:STATe]?	Set /Get the frequency count state
CALCulate:MARKer:AOff	Set the marker to all off
CALCulate:MARKer:X <freq> CALCulate:MARKer:X?	Set /Get the frequency of marker
CALCulate:MARKer:Y?	Get the level of marker
CALCulate:MARKer:NORMal:XPOS?	Get the x-coordinate of marker
CALCulate:MARKer:TT:XPOS?	Get the x-coordinate of delta deactivate marker
CALCulate:MARKer:TA:XPOS?	Get the x-coordinate of delta activate marker
CALCulate:MARKer:MAXimum	Seek maximum marker
CALCulate:MARKer:MAXimum:NEXT	Seek next maximum marker
CALCulate:MARKer:MAXimum:LEFT	Seek maximum marker on left
CALCulate:MARKer:MAXimum:RIGHT	Seek maximum marker on right
CALCulate:MARKer[:SET]:CENTER	Set marker to center
CALCulate:MARKer[:SET]:RLEVEL	Set marker to reference level

Ex1: Set the marker to ON

Command: CALCulate:MARKer:STATe ON

Ex2: Seek maximum marker

Command: CALCulate:MARKer:MAXimum

Ex3: Get the power of current marker

Command: CALCulate:MARKer:Y?

Return: 80.83

Means the level of current marker is 80.83 dBuV (As the unit of reference level is dBuV)

6. Trace

Command	Means
TRACe[:DATA]?	Get the trace data

7. NdB

Command	Means
CALCulate: BANDwidth: STATE<Boolean> CALCulate: BANDwidth: STATE?	Set /Get the NdB measurement state
CALCulate: BWIDth: STATE<Boolean> CALCulate: BWIDth: STATE?	Set /Get the reload NdB measurement state
CALCulate: BANDwidth: NDB<rel_ampl> CALCulate: BANDwidth: NDB?	Set /Get the NdB value
CALCulate: BWIDth: NDB<rel_ampl> CALCulate: BWIDth: NDB?	Set /Get the reload NdB value
CALCulate: BANDwidth: RESult? CALCulate: BWIDth: RESult?	Set /Get the NdB measurement result

Ex1: Set the NdB measurement state is on
 Command: CALCulate: BANDwidth: STATE ON

Ex2: Get the NdB measurement result
 Command: CALCulate: BANDwidth: RESult?
 Return: 58kHz
 Means the NdB measurement result is 58KHz.

- End of Document -