



S3331 Series Handheld Spectrum Analyzer

Quick Start Manual



Saluki Technology Inc.

The manual applies to the following models:

- S3331A handheld spectrum analyzer (9kHz-3.6GHz).
- S3331B handheld spectrum analyzer (9kHz-7.5GHz).

Standard Accessories of S3331 handheld spectrum analyzer

Item	Name	Qty
1	Main Machine	1 Set
2	AC/DC Adaptor	1 pcs
7	CD	1 pcs

Options of the S3331 handheld spectrum analyzer:

Option Number	Item
S3331-01	100kHz - 1.5GHz tracking source
S3331-02	100kHz - 3.2GHz tracking source
S3331-03	PC control software
S3331-04	Soft pack bag

Preface

Thanks for choosing S3331 handheld spectrum analyzer produced by Saluki Technology Inc. Please read this quick starter manual carefully for your convenience.

Manual No.

S3331-03-01

Version

Rev01 2016.09 Saluki Technology

Manual Authorization

The information contained in this Manual is subject to change without notice. The power to interpret the contents of and terms used in this Manual rests with Saluki.

Saluki Tech owns the copyright of this Manual which should not be modified or tampered by any organization or individual, or reproduced or transmitted for the purpose of making profit without its prior permission, otherwise Saluki will reserve the right to investigate and affix legal liability of infringement.

Product Quality Assurance

The warranty period of the product is 36 months from the date of delivery.

Product Quality Certificate

The product meets the indicator requirements of the manual at the time of delivery. Calibration and measurement are completed by the measuring organization with qualifications specified by the state, and relevant data are provided for reference.

Quality/Environment Management

Research, development, manufacturing and testing of the product comply with the requirements of the quality and environmental management system.

Precautions



Warning

"Warning" indicates danger. It reminds the user to pay attention to a certain operation process, operation method or similar situations. Noncompliance with the rules or improper operation may result in personal injuries. You must fully understand the warning and all the conditions in it shall be met before the next step



Attention

"Attention" indicates important prompts and no danger. It reminds the user to pay attention to a certain operation process, operation method or similar situations. Noncompliance with the rules or improper operation may result in damage to the instrument or loss of important data. You must fully understand the caution and all the conditions in it shall be met before the next step.

Contacts

Service Tel: 886.2.2175 2930

Website: www.salukitec.com

Email: info@salukitec.com

Address: No. 367 Fuxing N Road, Taipei 105, Taiwan (R.O.C.)

Content

1. Brief Introduction.....	6
1.1. Key Feature.....	6
1.2. Typical Applications.....	6
2. Safety Instructions.....	7
2.1. Device safety.....	7
2.2. Precautions on personal safety.....	7
3. Overview.....	9
3.1. Front Panel Overview.....	9
3.2. Function Keys description.....	10
3.3. Soft Keys.....	10
3.4. Interfaces on Side.....	11
3.5. User Interface.....	12
4. Typical Operation.....	14
4.1. Prepare.....	14
4.2. Continuous Signal Measurement.....	14
4.3. Measure two signals with small frequency interval.....	15
4.3.1. Resolving Two Signals of Equal Amplitude.....	15
4.3.2. Resolving Signals of Different Amplitudes.....	17
4.4. N dB Bandwidth Measurement.....	19
4.5. Adjacent Channel Power.....	20
4.6. Channel Power Measurement.....	21
4.7. Occupied Bandwidth Measurement.....	22
4.8. Use Pre-amplifier to Capture Weak Signals.....	23
4.9. Harmonic Distortion Measurement.....	24
4.10. TOI Distortion Measurement.....	25

1. Brief Introduction

S3331 handheld spectrum analyzer is designed for field use. It has a low weight, compact structure and a good performance. S3331 can be operated in field for 4 hours with battery power supply. It also provides telecommunication ports such as USB and LAN for remote data collection and remote control

1. 1. Key Feature

- Frequency range from 9kHz - 7.5GHz
- Sensitive, best DANL <-160dBm
- Low weight, small size, large bright screen, suitable for field use
- Standard LAN and USB interface, support SCPI
- Standard AM,FM demodulation functions. Optional tracking source function

1. 2. Typical Applications

- Spectrum Monitor
- Signal interference diagnose
- RF equipment on-site installation, test, maintenance

2. Safety Instructions

Please read safety instruction carefully and Strictly follow !

We will spare no efforts to ensure that production process comply with latest safety standards so as to safeguard the safety of our users. The design and tests of our products and accessory equipment comply with relevant safety standards. We have established quality assurance system so that we can better supervise product quality and ensure that all products accord with standards in the system. To maintain the sound state of equipment and ensure safe operation, please comply with the following instruction. Contact us if you have any questions.

It is also your responsibility to use this product in correct manner. Suitable for industrial, laboratory and field uses, this equipment, however, must be used in correct manner so as to prevent personal injuries and property damages. For problems caused by misuses, liabilities rest on users. By proper use, it means that users should use this product according to prescriptions in the product document and in the required conditions. As sufficient expertise is required, only professional technicians and people that have been strictly trained and have mastered necessary skills are qualified to use this product. Please keep safety manual and product document in a proper manner, and deliver them to the end user. To forestall personal injuries and property loss, please abide by these safety instructions. Prior to using this product, please read carefully and comply with these instructions accordingly.

2. 1. Device safety

- a) Use designated packing container in shipping and avoid falling or violent collisions in moving, which may cause damages to the device.
- b) Use AC-DC adapter shipped with the device to supply power/charge to the product. Using other power adapters may cause damages to internal hardware.
- c) Ensure that power supply is well connected to the ground to prevent damages to the device caused by poor connection or false connection.
- d) Injection of DC signal into input end is prohibited. Signal power needs to be lower than 0.5W. If not, damage to the device may occur.
- e) If device uses external or internal batteries, replace these batteries with the same or equivalent type of batteries. When using other types of batteries, blast may occur.
- f) Both insertions of objects into the gap of the device housing and dumping of liquids over device housing or into device are prohibited, which may cause short circuit, electric shock, fire or personal injuries.
- g) Notches or gaps in the device, designed to help internal ventilation and whereby prevent overheat, must not be covered. The device must not be put on couch, wrapped with carpet, or placed in airtight housing unless ventilation is good
- h) This device must not be placed on radiator, dish heater and other heating devices. Ambient temperature must not surpass the maximal temperature prescribed in this manual
- i) Attention: Once this device is on fire, it may release toxic gases or liquids.

2. 2. Precautions on personal safety.

- a) When moving the device, use proper tools and move the device softly so as to avoid personal injuries caused by the falling of the device.
- b) Device should be proper grounded so as to prevent personal injuries caused by poor or false grounding
- c) When cleaning the device, please unplug the device to avoid electric shock. Use dry or moist soft cloth to clean the device. Do not

clean the internal of the device.

- d) Before using this device, personnel need to be trained. When using the device, concentration is required. Operation by unqualified people may cause personal injuries and property losses.
- e) Use of this device when power line is broken is prohibited. Regular check on power line is necessary. Proper measures should be taken to keep power line in good state and prevent stumble and electric shock.
- f) Field use of the device when there is lightning is prohibited, which may cause personal injuries and property loss.

3. Overview

This chapter will help the user get to know S3331 quickly. This chapter includes introductions of:

- Front Panel
- Interface on side
- UI

3.1. Front Panel Overview

This Section will give a detailed introduction to the front panel of S3331. You can get generally familiar with the basic application of the panel keyboard of the instrument by reading it. The front panel of S3331 handheld spectrum analyzer is as shown below:



Figure 3-1 Front Panel of S3331 handheld spectrum analyzer

The front panel of S3331 handheld spectrum analyzer is composed of various parts, including ON/OFF key, reset key, function key area, number pad (character key) area and LED indicator.

No.	Description	No.	Description
①	LCD screen	⑦	Up/Down Arrow Key
②	Soft Keys	⑧	Number Key Zone
③	Function Keys	⑨	Tracking Source Output
④	Preset Key	⑩	LAN Port

No.	Description	No.	Description
⑤	Power Switch	⑪	USB Port
⑥	Knob	⑫	RF input

3. 2. Function Keys description

	<p>Frequency settings.</p> <p>Include Start Frequency, Stop frequency, center frequency</p>
	<p>Frequency span setting</p>
	<p>Amplitude Settings.</p> <p>Include Reference level, attenuator, pre-amplifier, scale settings.</p>
	<p>Bandwidth/Sweep settings.</p> <p>Include RBW, VBW, average, sweep time settings.</p>
	<p>Trace settings:</p> <p>Include detector, max hold, min hold settings</p>
	<p>Auto measurement</p>
	<p>Mode settings</p> <p>Include tracking source settings, demodulation settings, trigger, pass-fail functions</p>
	<p>Measurement mode selection:</p> <p>Include Spectrum, adjacent channel power, occupied bandwidth, Channel Power etc.</p>
	<p>System settings</p>
	<p>Marker functions</p>
	<p>Peak search functions</p>

3. 3. Soft Keys

When press a function key, a soft key menu will appear on the bottom of the screen. User can use a row of physical key (F1 - F6) to select the soft key show on screen. Please see the figure below.

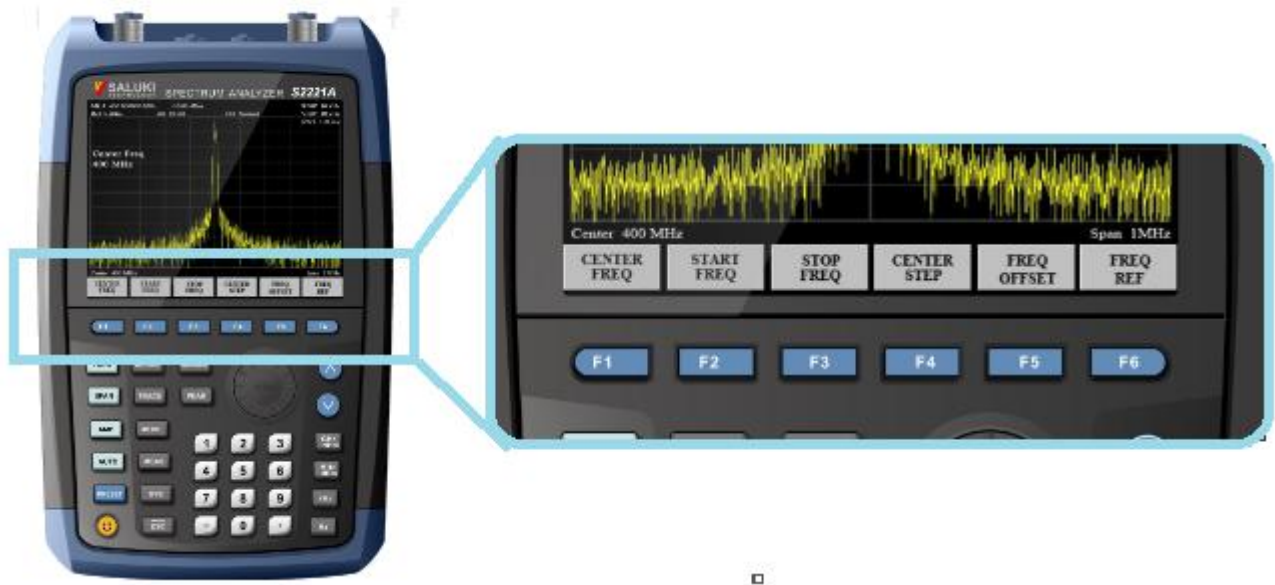

Figure 3-2 Soft Keys on S3331

3. 4. Interfaces on Side

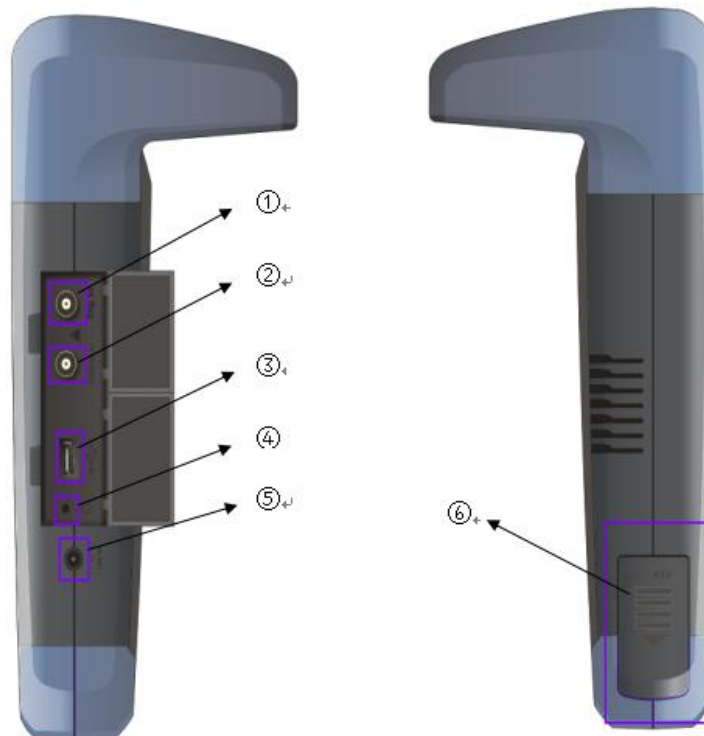

Figure 3-3 Side View of S3331 Handheld Spectrum Analyzer

No.	Description	No.	Description
①	External Trigger Input (BNC)	④	Ear phone interface
②	Reference Clock I/O (BNC)	⑤	Power adapter interface

No.	Description	No.	Description
③	USB Port	⑥	Battery hatch

3. 5. User Interface

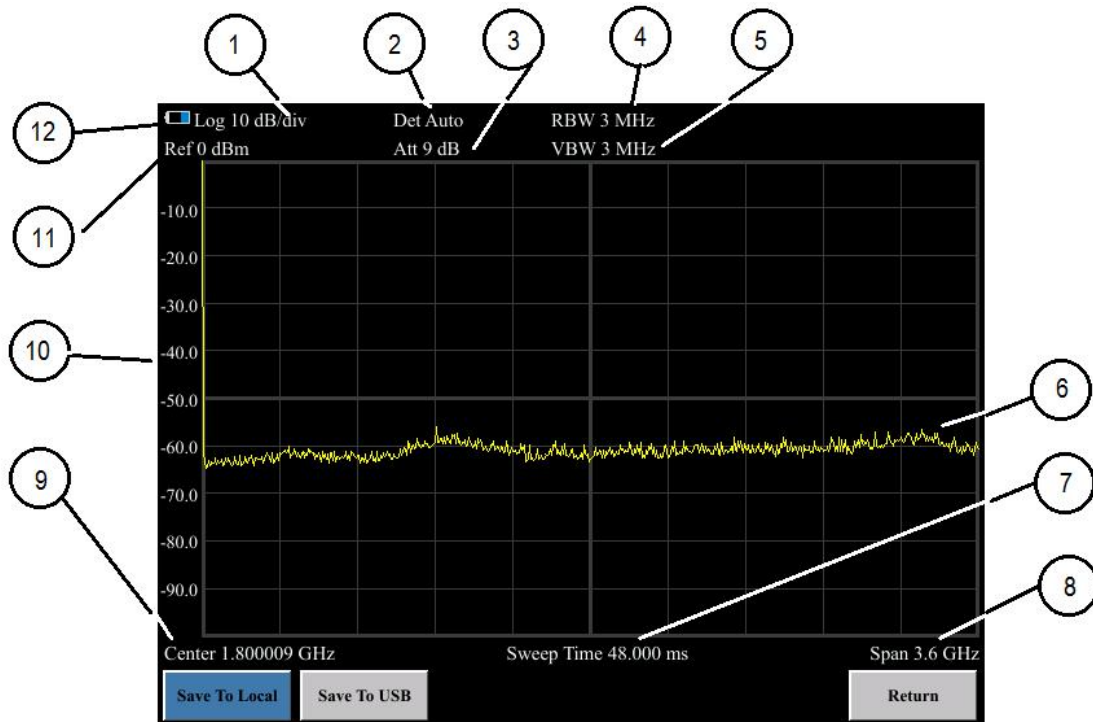

Figure 3-4 User Interface of S3331 Handheld spectrum analyzer

NO.	Name
①	Trace Display Format
②	Detector Type
③	Attenuator
④	RBW
⑤	VBW
⑥	Trace
⑦	Sweep time
⑧	Span
⑨	Center Frequency
⑩	Scale
⑪	Reference level

⑫

Battery Status

4. Typical Operation

This chapter will show how to use S3331 handheld spectrum analyzer, following functions are included:

- Continuous signal measurement
- Measure two signals with small frequency interval
- N dB bandwidth measurement
- Chanel power measurement
- Occupied bandwidth measurement
- Weak signal capture
- Harmonic distortion measurement
- TOI distortion measurement

4. 1. Prepare

Press the power button  to turn on S3331 handheld spectrum analyzer.

This chapter means to show the basic operations of S3331. So signal generators are used to simulate the signal source. Signal can be transmitted/received via a test cable or a pair of antennas.



Warning

Before any test, please ensure power level of input signal should not exceed +30dBm(1W), otherwise the instrument would be damaged.

4. 2. Continuous Signal Measurement

- 1) Set S1103 signal generator to generate a 300MHz, -10dBm continuous signal. Please refer to document S1103-03-01 for more details to set S1103 signal generator.
- 2) Connect S1103 signal generator output to S3331 handheld spectrum analyzer input. Or use antennas to transmit/receive the signal.
- 3) Preset the Instrument

Press **【PRESET】**  key . The instrument will return to default settings.

- 4) Frequency settings

■ Press **【FREQ】**  key.Frequency menu will show on the screen.

■ Select [Center Frequency].

■ Use number keys, knob or up/down arrow key to set the center frequency to 300MHz



- 5) Span setting

■ Press **【SPAN】**  key . Span menu will show on the screen

- Select [Span]
- Use number keys, knob or up/down arrow key to set span to 5MHz

By now the signal is show in the screen as shown in figure 4-1.

6) User a marker to measure the frequency and amplitude of the signal

- Press **【Marker】**  key → [Marker] → 1, activate Marker1.
- Press **【Peak】**  key, the marker will be moved to signal peak automatically. Marker information will be shown in up-right corner.

7) Readout the test result

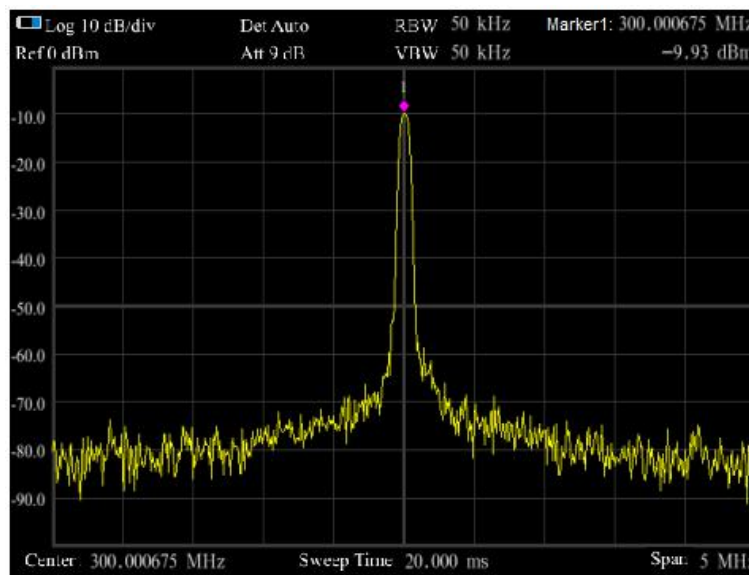

Fig 4-1: Continuous signal Test result

4. 3. Measure two signals with small frequency interval

Signal resolution is determined by the resolution bandwidth (RBW). When a signal passes through the filter, the spectrum analyzer will use the signal to sweep and display the band pass shape of the IF filter. So, when the spectrum analyzer receives two signals with equal amplitude and close frequency interval, the top of one band-pass filter waveform nearly covers another one, making two signals like one. If two signals of different amplitudes but close frequency interval, small signals may be totally hidden by large signals.

4. 3. 1. Resolving Two Signals of Equal Amplitude

Generally, to resolve two signals of equal amplitude, the resolution bandwidth must be less than or equal to the frequency interval of the two signals. For example, to resolve two signals of equal amplitude and a frequency interval of 100 kHz, the resolution bandwidth of the spectrum analyzer should be set less than or equal to 100 kHz.

Example

Take measuring two signals of equal amplitude with a frequency interval of 100kHz as an example, the measurement steps are as follows:

- 1) Connect the outputs of two signal generators to the spectrum analyzer RF input port using a T-shaped connector, as shown in

Figure below.

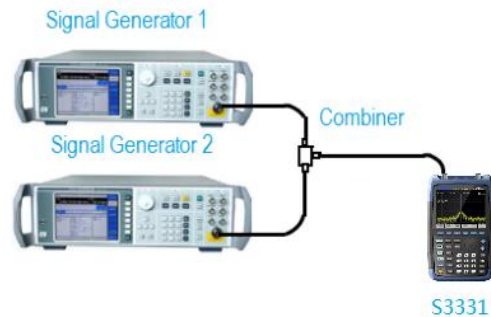





Fig 4-2: Equipment Connection for 2 signal capture

- 2) Set the frequency of one signal generator to 1800.4995MHz and the other to 1800.5005MHz. Set the output amplitude of both to -20dBm. Respectively adjust the signal output amplitude of two signal generators and view the signals displayed on the spectrum analyzer to make the displayed amplitudes of two signals equal.
- 3) Set up the spectrum analyzer to view signals.

- Press **【Preset】** ,
- Press **【Freq】** ,
- Select [Center Freq] and input 1800[MHz],
- Press **【Span】**  key and select [Span], input 50[kHz];
- Press **【BW/SWP】** , select [Res BW Auto Man], input 1[kHz].

At this moment, 2 signal peak can be seen on the screen of the spectrum analyzer but the 2 signals are not clearly separated, as shown in Figure below

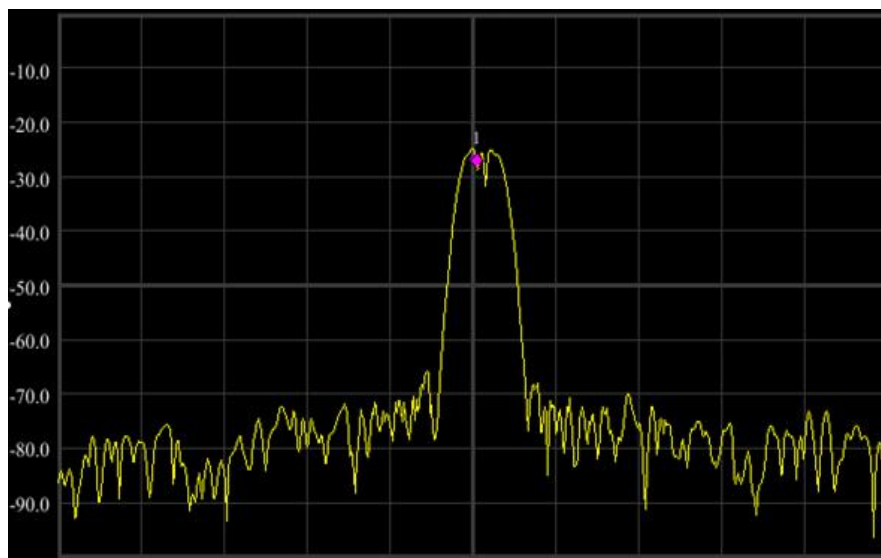

Fig 4-3: 1KHz RBW Trace

4) Optimize the test result. Lower the RBW to 100kHz.

- Press **【BW/SWP】** , [Res BW Auto Man], input 100[Hz]

Then the 2 signals are clearly shown in screen as shown in figure below

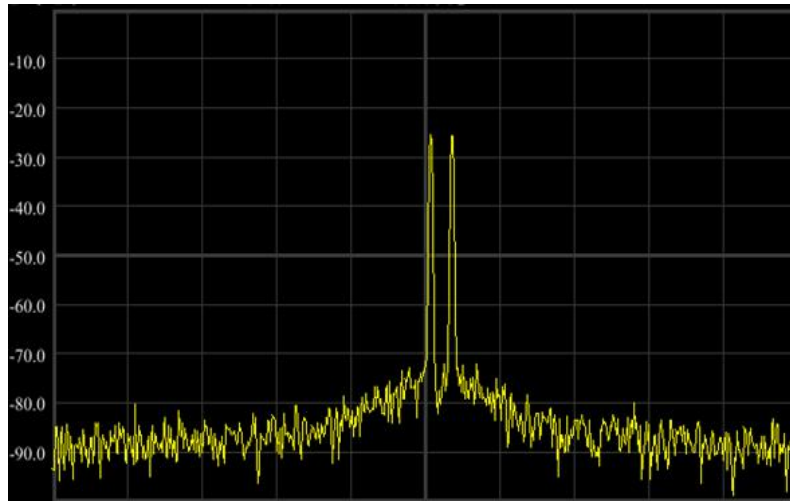

Fig 4-4: 100Hz RBW Trace

4. 3. 2. Resolving Signals of Different Amplitudes

To resolve two signals of different amplitudes, the resolution bandwidth must be equal to or less than the frequency interval of the two signals (same as resolving two signals of equal amplitude). But the maximum resolution bandwidth for resolving two signals with different amplitudes mainly depends on the squareness factor of IF filters other than the bandwidth 3dB.

Squareness factor is defined as the ratio of 60dB bandwidth to 3dB bandwidth of the intermediate frequency filter, as shown in Figure below.

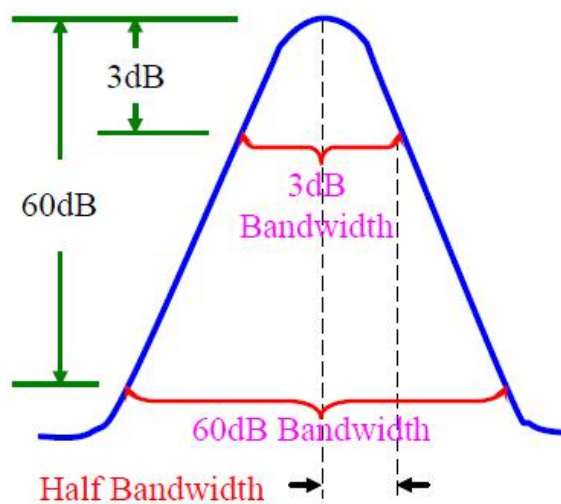





Figure 4-5 Schematic of Bandwidth and Squareness Factor

Example

Take resolving two signals of different amplitudes with frequency difference of 50 kHz and amplitude drop of 40dB as an example to explain the testing steps:

- 1) As shown in Figure 3-5, connect the outputs of two signal generators to the spectrum analyzer input.
- 2) Set the frequency of one signal generator to 1800MHz and amplitude to -10dBm. Set the frequency of the other signal generator to 1800.05MHz and signal output amplitude to -50dBm. Turn on the RF outputs of the two signal generators.
- 3) Set the spectrum analyzer to observe the signal:

- Press **【Preset】** ;
- Press **【Freq】** , [Center Freq], 1800.025[MHz].
- Press **【Span】** , 500[kHz].
- Press **【BW/Swp】** , [Res BW Auto Man], 30[kHz].

The squareness factor of the resolution bandwidth filter of S3331 Handheld Microwave Spectrum Analyzer is 5:1, when the resolution bandwidth is 30kHz, the bandwidth on 60dB point is 115kHz, the half bandwidth is 57.5kHz, which is wider than the frequency interval of 50kHz, so the two input signals cannot be resolved, as shown in Figure 4-6.

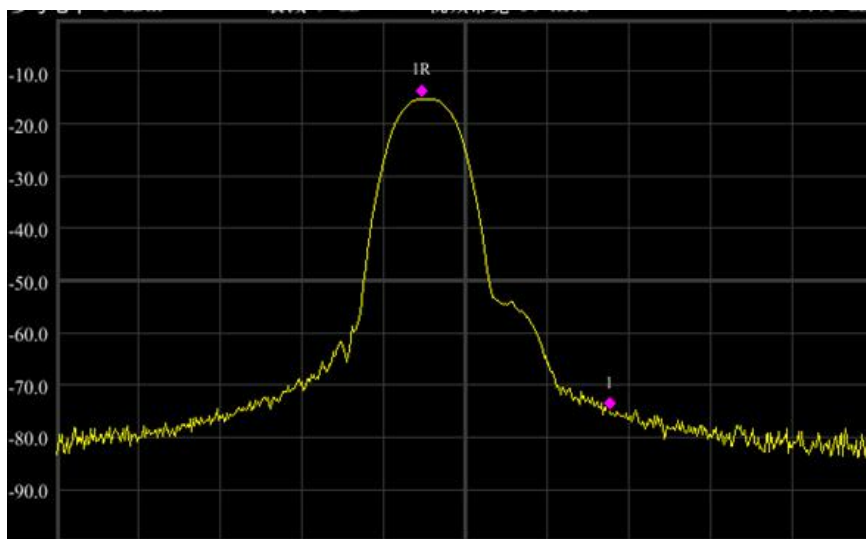



Figure 4-6: 30KHz RBW

- 4) Reduce the resolution bandwidth to view the small signals hidden.

- Press **【BW/SWP】** , [Res BW Auto Man], 1[kHz].

At this moment, the half bandwidth is narrower than the frequency interval of 50 kHz, so the two input signals can be resolved. The two signals could be clearly seen on the screen.

- 5) Read the frequency difference and amplitude difference by the marker.

- Press **【Peak】**  and put the marker on the peak of the large signal;
- Press **【Marker】** , [Delta], to enable the delta marker;

- Press **【Peak】**  , **【Next Peak】** to put the delta marker on the peak of small signal.

Now, the frequency difference and amplitude difference of the two signals with difference amplitudes can be read, as shown in following figure.

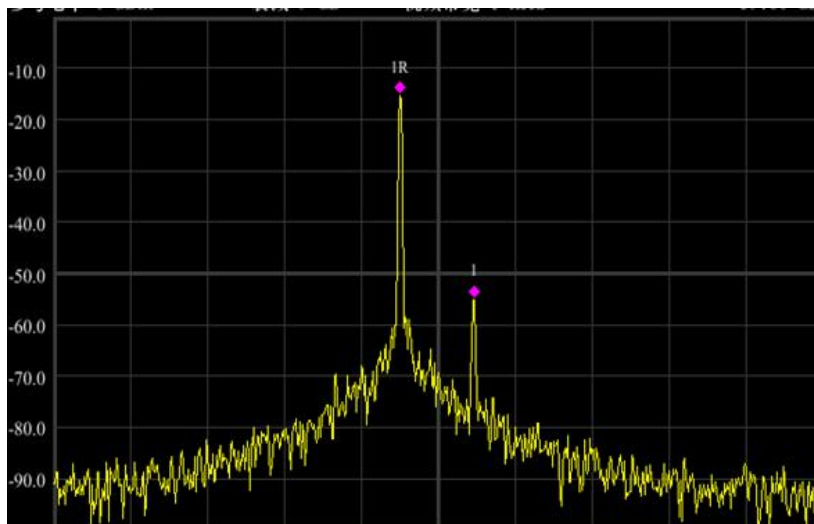





Figure 4-7: 1KHz RBW

4. 4. N dB Bandwidth Measurement

Following example uses a S1103 signal generator and generates a 500MHz, -10dBm continuous signal.

Example

- 1) Connect the signal generator output port to S3331 RF test port.
- 2) Press **【Preset】**  key to return the instrument to default status
- 3) Set test frequency.

- Press **【FREQ】**  key
- Select [Center FREQ] and input 500MHz
- Press **【SPAN】**  key
- Select [Span] and input 1MHz

- 4) Press **【BW/SWP】**  key,
 - Select [Res BW Auto Man] and input 30kHz.

Now the signal trace is displayed on screen as shown in following figure.

- 5) Press **【Marker】**  key, select [Next Page], select [Marker Function]

- 6) Select [NdB On Off], turn on the NdB bandwidth measure function. The default value of NdB is 3dB. The value can be changed by selecting [NdB] and input the required value.
- 7) Read out the result

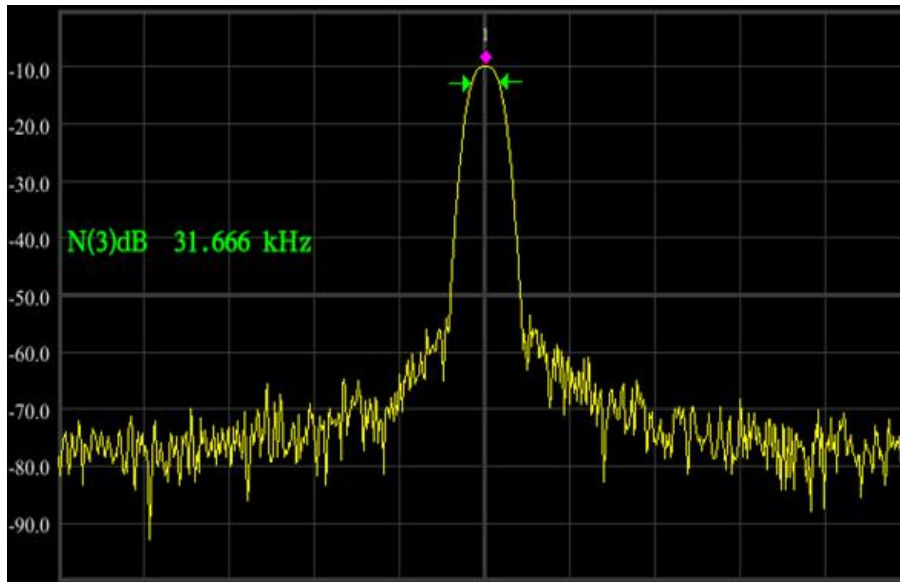





Figure 4-8: 3dB Bandwidth Test Result

4. 5. Adjacent Channel Power

Following example uses a S1103 signal generator and generates a 500MHz, -10dBm continuous signal.

Example

- 1) Connect the signal generator output port to S3331 RF test port.
- 2) Press **【Preset】**  key to return the instrument to default status
- 3) Set test frequency.
 - Press **【FREQ】**  key
 - Select [Center FREQ] and input 500MHz
- 4) Press **【Meas】**  key. Select [Adjacent Power]

The trace will be displayed as shown in the figure below.

- 5) Read out the result

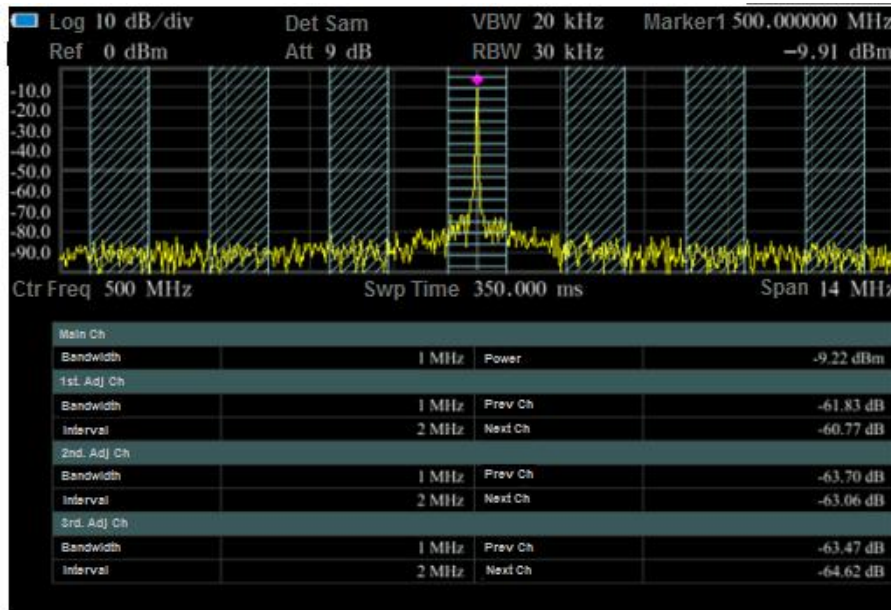





Figure 4-9: Adjacent Channel Measurement

4. 6. Channel Power Measurement

Following example uses a S1103 signal generator and generates a 500MHz, -10dBm continuous signal.

Example

- 1) Connect the signal generator output port to S3331 RF test port.
- 2) Press **【Preset】**  key to return the instrument to default status
- 3) Set test frequency.
 - Press **【FREQ】**  key
 - Select [Center FREQ] and input 500MHz
- 4) Press **【Meas】**  key. Select [Channel Power On Off], turn on the function

The trace will be displayed as shown in the figure below.

- 5) Read out the result

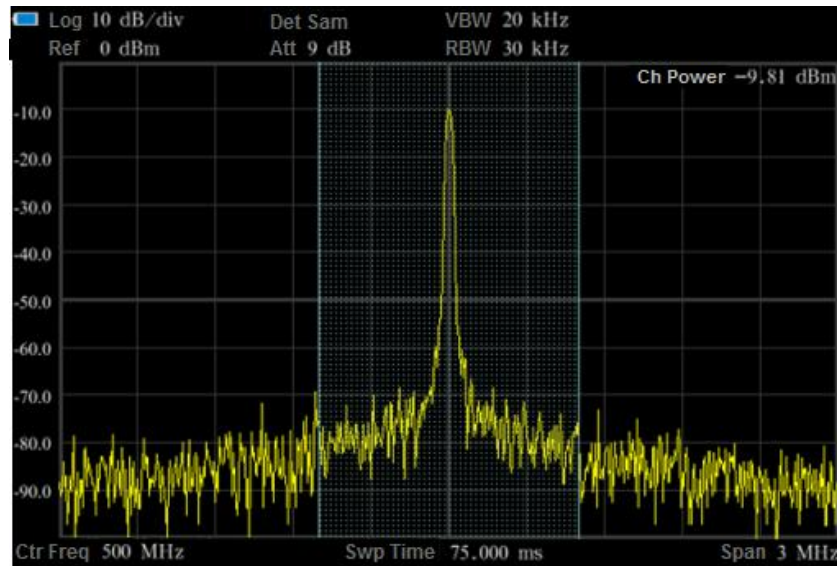





Figure 4-10: Channel Power Measurement

4. 7. Occupied Bandwidth Measurement

Following example uses a S1103 signal generator and generates a 500MHz, -10dBm continuous signal.

Example

- 1) Connect the signal generator output port to S3331 RF test port.
- 2) Press **【Preset】**  key to return the instrument to default status
- 3) Set test frequency.
 - Press **【FREQ】**  key
 - Select [Center FREQ] and input 500MHz
- 4) Press **【Meas】**  key. Select [Occupied BW On Off], turn on the function

The trace will be displayed as shown in the figure below.

- 5) Read out the result

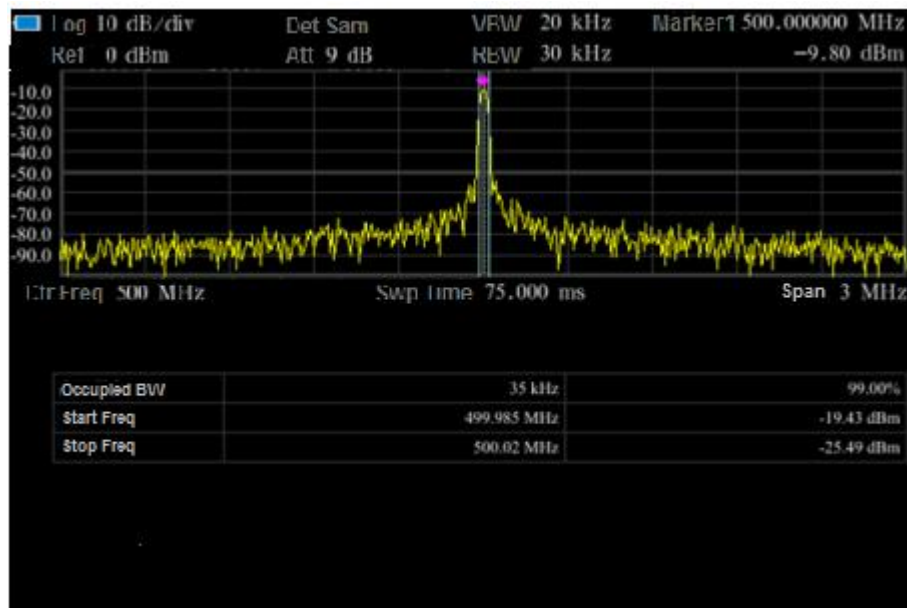





Figure 4-10: Occupied Bandwidth Measurement

4. 8. Use Pre-amplifier to Capture Weak Signals

Following example uses a S1103 signal generator and generates a 500MHz, -80dBm continuous signal.

Example

- 1) Connect the signal generator output port to S3331 RF test port.
- 2) Press **【Preset】**  key to return the instrument to default status
- 3) Set test frequency.
 - Press **【FREQ】**  key
 - Select [Center FREQ] and input 500MHz
 - Press **【Span】**  key
 - Select [Span] and input 10MHz
- 4) Enable the pre-amplifier
 - Press **【AMP】**  key
 - Select [Ref level] and input -20dBm
 - Select [Pre Amp On Off], enable the pre-amplifier

The trace will be displayed as shown in the figure below.

- 5) Read out the result

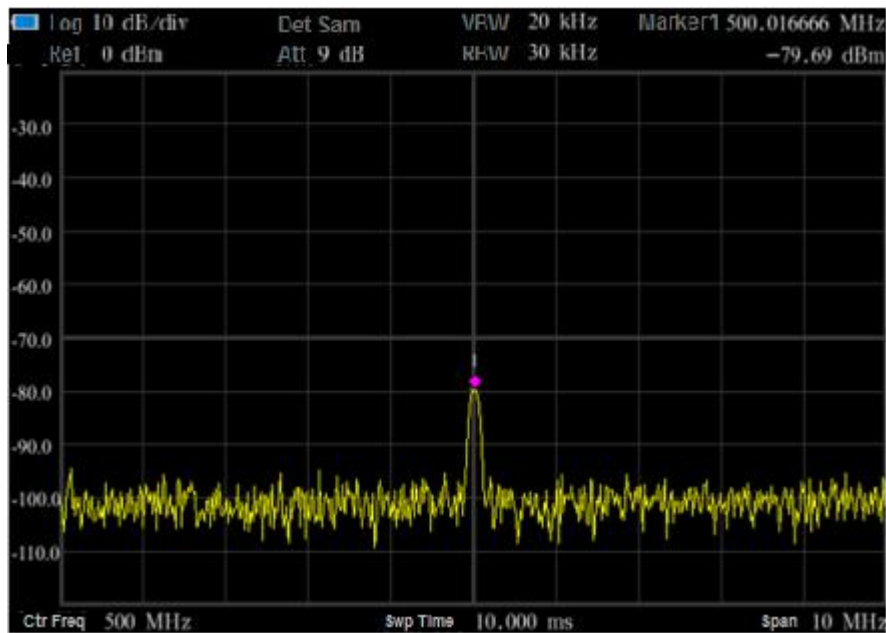



Figure 4-11: Pre-amplifier On Measurement





4. 9. Harmonic Distortion Measurement

Following example uses a S1103 signal generator and generates a 300MHz, -10dBm continuous signal.

Example

- 1) Connect the signal generator output port to S3331 RF test port.
- 2) Press **【Preset】**  key to return the instrument to default status
- 3) Set test frequency.
 - Press **【FREQ】**  key
 - Select [Start FREQ] and input 200MHz
 - Select [Stop FREQ] and input 1GHz

The trace will be displayed as shown in the figure below. There are 3 peaks, signal, the second harmonic and the third harmonic.

- 4) Use **【Peak】**  and **【Marker】**  keys to do the analyze.
 - Press **【Peak】**  key, S3331 will search the MAX value and mark it with a marker 1. In this example, the marker 1 is located at 300MHz and -10dBm signal which is the input signal.
 - Press **【Marker】**  key
 - Select [Delta], a Marker 2 is activated and it is a Delta marker, the reference marker is Marker 1.
 - Press **【Peak】**  key. Then Marker 2 will be located to the second harmonic. Read out the frequency and amplitude

difference.

- Press **【Peak】**  key and select [Next Peak], then marker 2 will move to the third harmonic. Read out the frequency and amplitude difference.

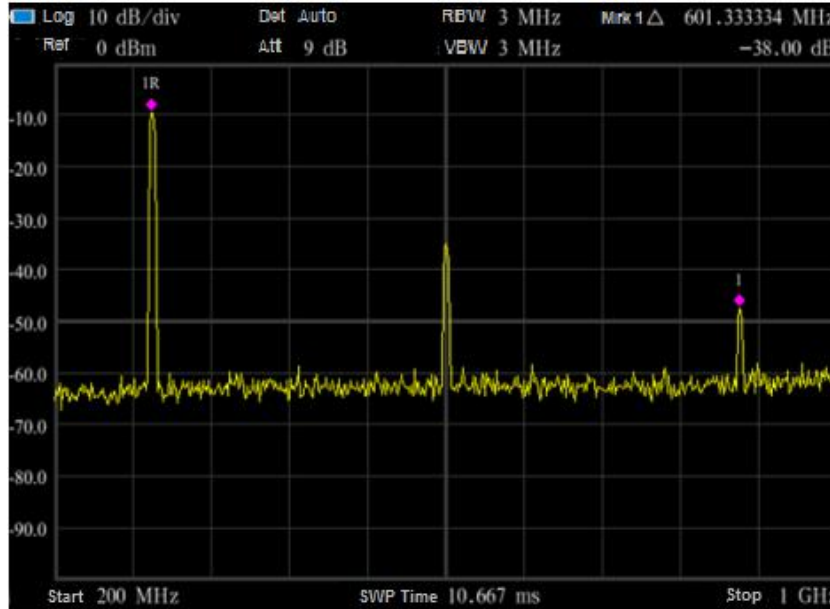

Fig4-12: Harmonic Distortion Measurement

4. 10. TOI Distortion Measurement

In following example, use 2x signal generator to generate a 500MHz, -10dBm Sine signal and a 501MHz, -10dBm sine signal.

Example

- 1) Connect the outputs of two signal generators to the spectrum analyzer RF input port using a T-shaped connector, as shown in Figure below.

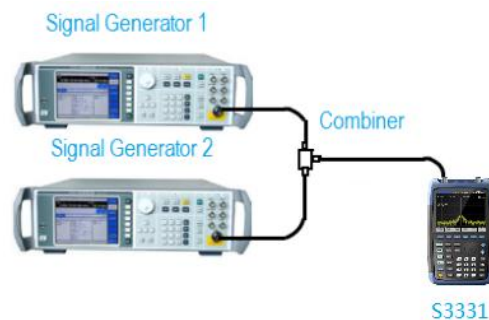









Fig 4-13: TOI Distortion Measurement Connection

- 2) Press **【Preset】**  key to return the instrument to default status
- 3) Set test frequency.
 - Press **【FREQ】**  key

- Select [Ctr FREQ] and input 500MHz
 - Press 【SPAN】  key
 - Select [SPAN] and input 5MHz
 - Press 【BW/SWP】  key
 - Select [Res BW Auto Man] and input 1kHz
- 4) Use 【Peak】  and 【Marker】  keys to do the analyze.
- Press 【Peak】  key, S3331 will search the MAX value and mark it with a marker 1.
 - Press 【Marker】  key
 - Select [Delta], a Marker 2 is activated and it is a Delta marker, the reference marker is Marker 1.
 - Press 【Peak】  key. Select [Next Peak].
- 5) Readout the value of Marker 2. It is the TOI distortion

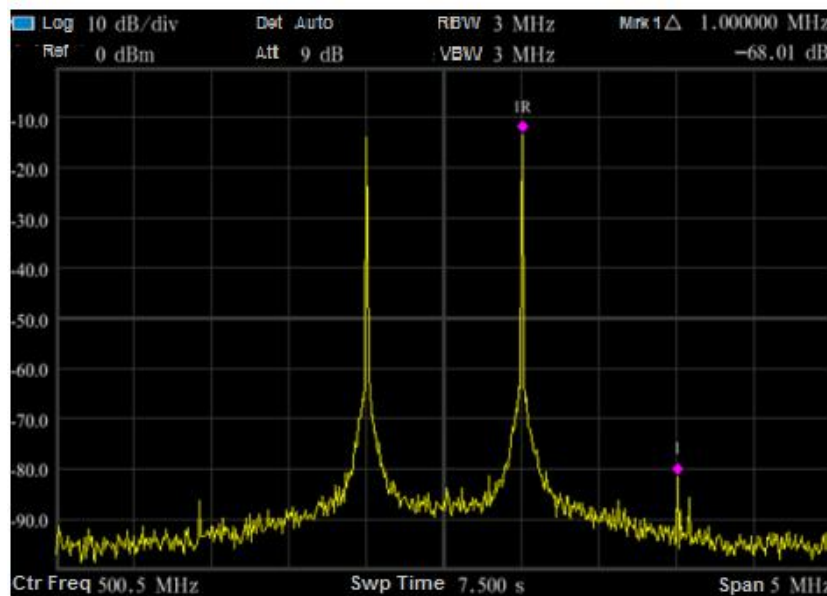

Fig 4-14: TOI Distortion Measurement

-End of Document-